

VIPA System 200V

CPU | 215-2BT16 | Manual

HB97 | CPU | 215-2BT16 | GB | 16-17

CPU 215NET

VIPA GmbH
Ohmstr. 4
91074 Herzogenaurach
Telephone: +49 9132 744-0
Fax: +49 9132 744-1864
Email: info@vipa.com
Internet: www.vipa.com

Table of contents

1	General	5
1.1	Copyright © VIPA GmbH	5
1.2	About this manual.....	6
1.3	Safety information.....	7
2	Basics and Assembly	9
2.1	Safety information for users.....	9
2.2	System conception.....	10
2.3	Dimensions.....	12
2.4	Mounting.....	13
2.5	Demounting and module exchange.....	18
2.6	Wiring.....	19
2.7	Installation guidelines.....	20
2.8	General data.....	23
3	Hardware description	25
3.1	Properties.....	25
3.2	Structure.....	26
3.2.1	General.....	26
3.2.2	Interfaces.....	26
3.2.3	Memory management.....	27
3.2.4	Storage media slot	27
3.2.5	Battery backup for clock and RAM.....	28
3.2.6	Operating mode switch.....	28
3.2.7	LEDs.....	29
3.3	Technical data.....	30
4	Deployment	36
4.1	Assembly.....	36
4.2	Start-up behavior.....	36
4.3	Addressing.....	37
4.4	Hints for the deployment of the MPI interface.....	38
4.5	Hardware configuration - CPU.....	39
4.6	Hardware configuration - I/O modules.....	41
4.7	Hardware configuration - Ethernet PG/OP channel.....	41
4.8	Setting CPU parameters.....	43
4.8.1	Parameter CPU.....	44
4.9	Project transfer.....	46
4.9.1	Transfer via MPI.....	46
4.9.2	Transfer via Ethernet.....	49
4.9.3	Transfer via MMC.....	49
4.10	Operating modes.....	50
4.11	Overall reset.....	52
4.12	Firmware update.....	54
4.13	Factory reset.....	56
4.14	Diagnostic entries.....	56
4.15	Using test functions for control and monitoring of variables.....	58
5	Deployment Ethernet communication	60
5.1	Basics - Industrial Ethernet in automation.....	60

5.2	Basics - ISO/OSI reference model.....	61
5.3	Basics - Terms.....	62
5.4	Basics - Protocols.....	63
5.5	Basics - IP address and subnet.....	65
5.6	Basics - MAC address and TSAP.....	67
5.7	Fast introduction.....	68
5.8	Commissioning and initialization.....	68
5.9	Hardware configuration - CPU.....	69
5.10	Project engineering CP 243	71
5.11	Configure connections.....	71
5.11.1	Overview.....	71
5.11.2	Siemens NetPro.....	72
5.11.3	Connection type - Send/Receive.....	76
5.12	NCM diagnostic - Help for error diagnostic.....	85
5.13	Coupling to other systems.....	87
5.14	Example communication CPU 215-2BT16.....	90
5.14.1	Monitoring the data transfer in the Siemens SIMATIC manager	94
6	Configuration with TIA Portal.....	96
6.1	TIA Portal - Limitations.....	96
6.2	TIA Portal - Work environment	96
6.2.1	General.....	96
6.2.2	Work environment of the TIA Portal.....	97
6.3	TIA Portal - Hardware configuration - CPU	98
6.3.1	Virtual PROFIBUS master system.....	99
6.4	TIA Portal - Hardware configuration - I/O modules.....	101
6.5	TIA Portal - Hardware configuration - Ethernet PG/OP channel.....	102
6.6	TIA Portal - Project transfer.....	104

1 General

1.1 Copyright © VIPA GmbH

All Rights Reserved

This document contains proprietary information of VIPA and is not to be disclosed or used except in accordance with applicable agreements.

This material is protected by the copyright laws. It may not be reproduced, distributed, or altered in any fashion by any entity (either internal or external to VIPA), except in accordance with applicable agreements, contracts or licensing, without the express written consent of VIPA and the business management owner of the material.

For permission to reproduce or distribute, please contact: VIPA, Gesellschaft für Visualisierung und Prozessautomatisierung mbH Ohmstraße 4, D-91074 Herzogenaurach, Germany

Tel.: +49 9132 744 -0

Fax.: +49 9132 744-1864

E-Mail: info@vipa.de

<http://www.vipa.com>



Every effort has been made to ensure that the information contained in this document was complete and accurate at the time of publishing. Nevertheless, the authors retain the right to modify the information.

This customer document describes all the hardware units and functions known at the present time. Descriptions may be included for units which are not present at the customer site. The exact scope of delivery is described in the respective purchase contract.

CE Conformity Declaration

Hereby, VIPA GmbH declares that the products and systems are in compliance with the essential requirements and other relevant provisions. Conformity is indicated by the CE marking affixed to the product.

Conformity Information

For more information regarding CE marking and Declaration of Conformity (DoC), please contact your local VIPA customer service organization.

About this manual

Trademarks

VIPA, SLIO, System 100V, System 200V, System 300V, System 300S, System 400V, System 500S and Commander Compact are registered trademarks of VIPA Gesellschaft für Visualisierung und Prozessautomatisierung mbH.

SPEED7 is a registered trademark of profichip GmbH.

SIMATIC, STEP, SINEC, TIA Portal, S7-300 and S7-400 are registered trademarks of Siemens AG.

Microsoft and Windows are registered trademarks of Microsoft Inc., USA.

Portable Document Format (PDF) and Postscript are registered trademarks of Adobe Systems, Inc.

All other trademarks, logos and service or product marks specified herein are owned by their respective companies.

Information product support

Contact your local VIPA Customer Service Organization representative if you wish to report errors or questions regarding the contents of this document. If you are unable to locate a customer service centre, contact VIPA as follows:

VIPA GmbH, Ohmstraße 4, 91074 Herzogenaurach, Germany

Telefax: +49 9132 744-1204

E-Mail: documentation@vipa.de

Technical support

Contact your local VIPA Customer Service Organization representative if you encounter problems with the product or have questions regarding the product. If you are unable to locate a customer service centre, contact VIPA as follows:

VIPA GmbH, Ohmstraße 4, 91074 Herzogenaurach, Germany

Tel.: +49 9132 744-1150 (Hotline)

E-Mail: support@vipa.de

1.2 About this manual

Objective and contents

This manual describes the CPU 215-2BT16 of the System 200V from VIPA. It contains a description of the construction, project implementation and usage.

Product	Order number	as of state:		
		CPU-HW	CPU-FW	CP-FW
CPU 215NET	215-2BT16	01	V 4.2.1	V 2.7.4.5

Target audience

The manual is targeted at users who have a background in automation technology.

Structure of the manual

The manual consists of chapters. Every chapter provides a self-contained description of a specific topic.

- Guide to the document** The following guides are available in the manual:
- An overall table of contents at the beginning of the manual
 - References with page numbers
- Availability** The manual is available in:
- printed form, on paper
 - in electronic form as PDF-file (Adobe Acrobat Reader)
- Icons Headings** Important passages in the text are highlighted by following icons and headings:

**DANGER!**

Immediate or likely danger. Personal injury is possible.

**CAUTION!**

Damages to property is likely if these warnings are not heeded.



Supplementary information and useful tips.

1.3 Safety information

Applications conforming with specifications

The system is constructed and produced for:

- communication and process control
- general control and automation tasks
- industrial applications
- operation within the environmental conditions specified in the technical data
- installation into a cubicle

**DANGER!**

This device is not certified for applications in
– in explosive environments (EX-zone)

Documentation

The manual must be available to all personnel in the

- project design department
- installation department
- commissioning
- operation

**CAUTION!**

The following conditions must be met before using or commissioning the components described in this manual:

- Hardware modifications to the process control system should only be carried out when the system has been disconnected from power!
- Installation and hardware modifications only by properly trained personnel.
- The national rules and regulations of the respective country must be satisfied (installation, safety, EMC ...)

Disposal

National rules and regulations apply to the disposal of the unit!

2 Basics and Assembly

2.1 Safety information for users

Handling of electrostatic sensitive modules

VIPA modules make use of highly integrated components in MOS-Technology. These components are extremely sensitive to over-voltages that can occur during electrostatic discharges. The following symbol is attached to modules that can be destroyed by electrostatic discharges.



The Symbol is located on the module, the module rack or on packing material and it indicates the presence of electrostatic sensitive equipment. It is possible that electrostatic sensitive equipment is destroyed by energies and voltages that are far less than the human threshold of perception. These voltages can occur where persons do not discharge themselves before handling electrostatic sensitive modules and they can damage components thereby, causing the module to become inoperable or unusable. Modules that have been damaged by electrostatic discharges can fail after a temperature change, mechanical shock or changes in the electrical load. Only the consequent implementation of protection devices and meticulous attention to the applicable rules and regulations for handling the respective equipment can prevent failures of electrostatic sensitive modules.

Shipping of modules

Modules must be shipped in the original packing material.

Measurements and alterations on electrostatic sensitive modules

When you are conducting measurements on electrostatic sensitive modules you should take the following precautions:

- Floating instruments must be discharged before use.
- Instruments must be grounded.

Modifying electrostatic sensitive modules you should only use soldering irons with grounded tips.



CAUTION!

Personnel and instruments should be grounded when working on electrostatic sensitive modules.

2.2 System conception

Overview

The System 200V is a modular automation system for assembly on a 35mm profile rail. By means of the peripheral modules with 4, 8 and 16 channels this system may properly be adapted matching to your automation tasks.

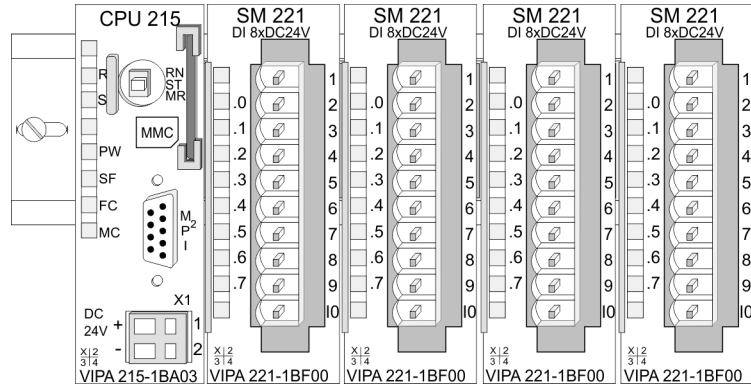

Components

The System 200V consists of the following components:

- Head modules like CPU and bus coupler
- Periphery modules like I/O, function and communication modules
- Power supplies
- Extension modules

Head modules

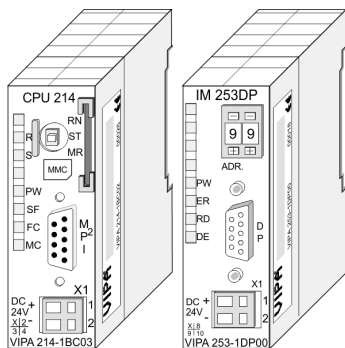

With a head module CPU respectively bus interface and DC 24V power supply are integrated to one casing. Via the integrated power supply the CPU respectively bus interface is power supplied as well as the electronic of the connected periphery modules

Periphery modules

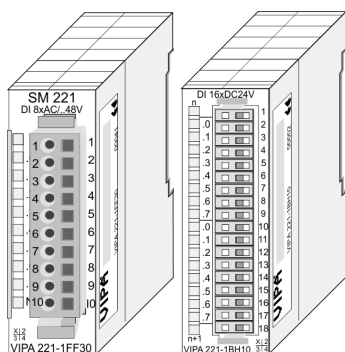

The modules are direct installed on a 35mm profile rail and connected to the head module by a bus connector, which was mounted on the profile rail before. The periphery modules are equipped with a 10pin respectively 18pin connector with recessed labelling. This connector provides the electrical interface for the signalling and supplies lines of the modules.

Power supplies

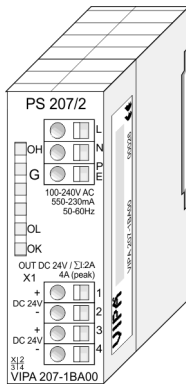

With the System 200V the DC 24V power supply can take place either externally or via a particularly for this developed power supply. The power supply may be mounted on the profile rail together with the System 200V modules. It has no connector to the back-plane bus.

Extension modules

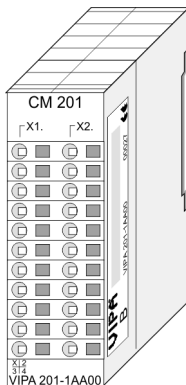

The expansion modules are complementary modules providing 2- or 3wire connection facilities. The modules are not connected to the backplane bus.

Structure/dimensions

- Profile rail 35mm
- Dimensions of the basic enclosure:
 - 1tier width: (HxWxD) in mm: 76x25.4x74 in inches: 3x1x3
 - 2tier width: (HxWxD) in mm: 76x50.8x74 in inches: 3x2x3

Installation

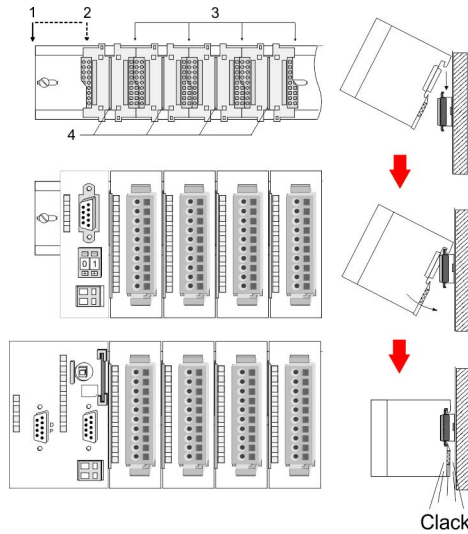

- 1 Head module (double width)
- 2 Head module (double width)
- 3 Periphery modules
- 4 Guide rails

Please note that you can only install header modules, like the CPU, the PC and couplers at slot 1 or 1 and 2 (for double width modules).



A maximum of 32 modules can be connected at the back plane bus. Take attention that here the maximum sum current of 3.5A is not exceeded. Please install modules with a high current consumption directly beside the header module.

2.3 Dimensions

Dimensions basic enclosure

- 2tier width (HxWxD) in mm: 76 x 50.8 x 74

Installation dimensions

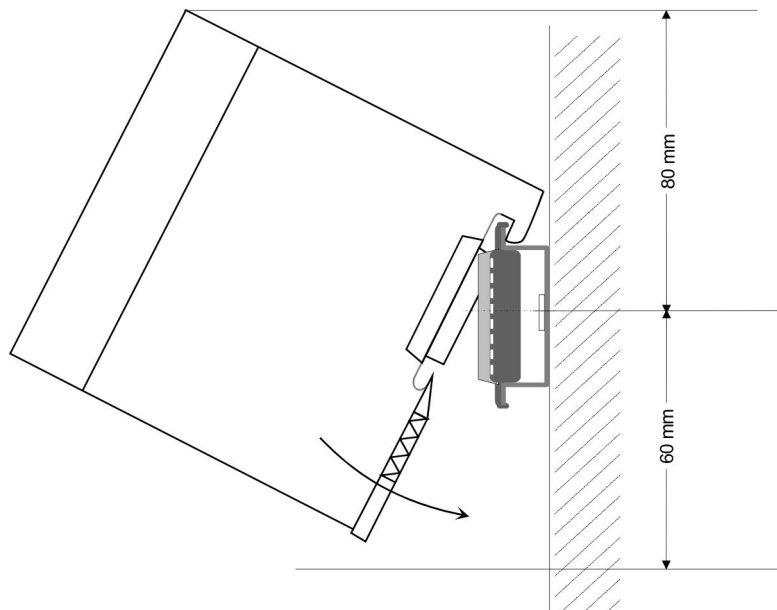

Installed and wired dimensions

CPU
here with EasyConn plug from VIPA

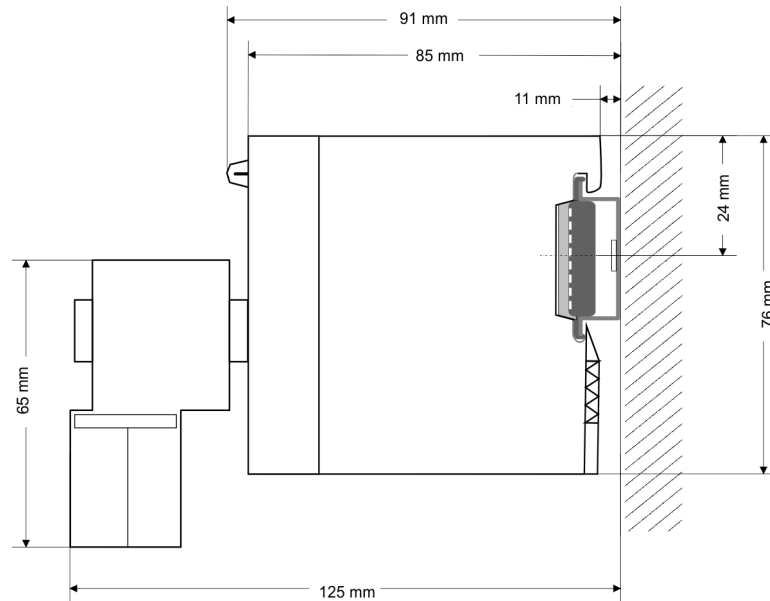

2.4 Mounting

General

The modules are each installed on a 35mm profile rail and connected via a bus connector. Before installing the module the bus connector is to be placed on the profile rail before.

Profile rail

For installation the following 35mm profile rails may be used:

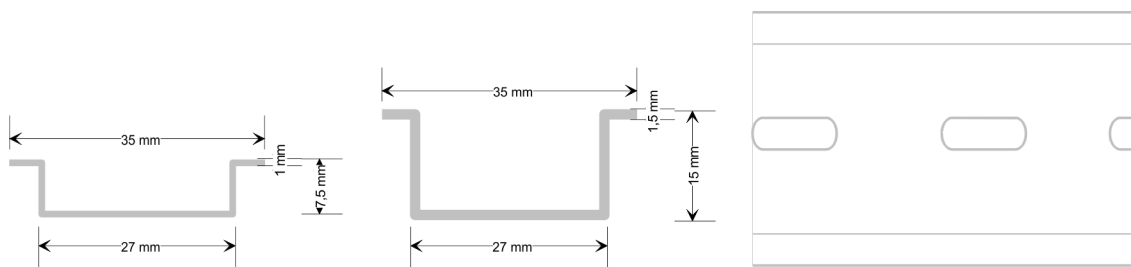

Order number	Designation	Description
290-1AF00	35mm profile rail	Length 2000mm, height 15mm
290-1AF30	35mm profile rail	Length 530mm, height 15mm

Bus connector

System 200V modules communicate via a backplane bus connector. The backplane bus connector is isolated and available from VIPA in of 1-, 2-, 4- or 8tier width. The following figure shows a 1tier connector and a 4tier connector bus:

Mounting

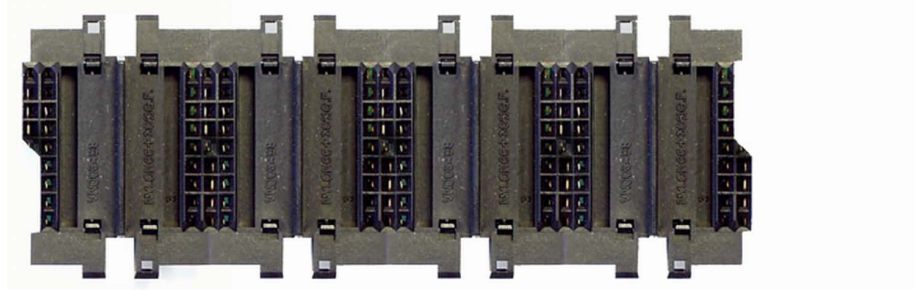
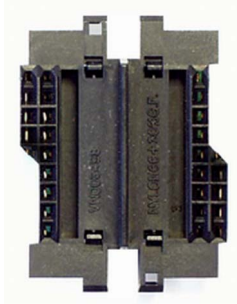

The bus connector is to be placed on the profile rail until it clips in its place and the bus connections look out from the profile rail.

Bus connector

Order number	Designation	Description
290-0AA10	Bus connector	1tier
290-0AA20	Bus connector	2tier
290-0AA40	Bus connector	4tier
290-0AA80	Bus connector	8tier

Installation on a profile rail

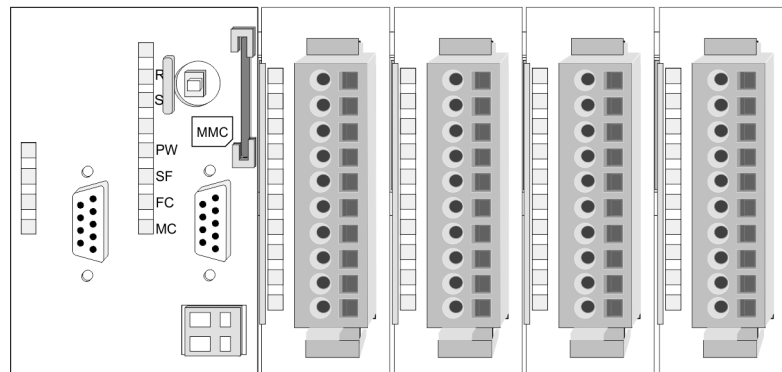
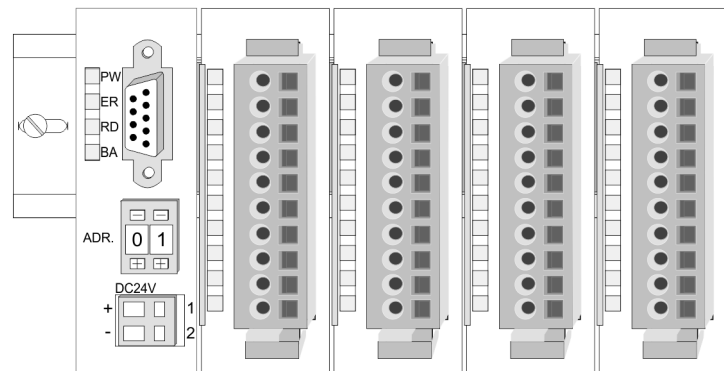
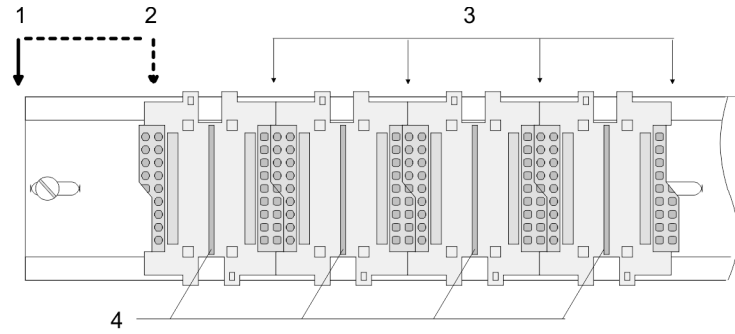

- 1 Head module (double width)
- 2 Head module (single width)
- 3 Periphery modules
- 4 Guide rails

The figure shows the installation of a 4tier width bus connector in a profile rail and the slots for the modules. The different slots are defined by guide rails.

Assembly regarding the current consumption

- Use bus connectors as long as possible.
- Sort the modules with a high current consumption right beside the header module. In the service area of www.vipa.com a list of current consumption of every System 200V module can be found.

Mounting

Assembly possibilities

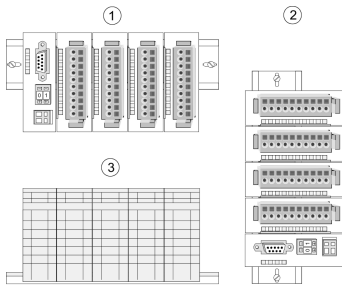

Please regard the allowed environmental temperatures:

- 1 horizontal assembly: from 0 to 60°C
- 2 vertical assembly: from 0 to 40°C
- 3 lying assembly: from 0 to 40°C

The horizontal assembly always starts at the left side with a header module, then you install the peripheral modules beside to the right. You may install up to 32 peripheral modules.

Please regard at installation!

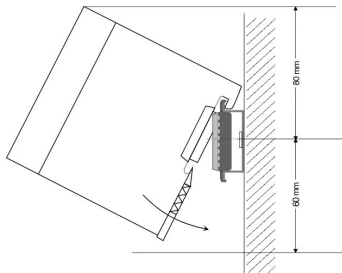

- 1. Turn off the power supply before you install or remove any modules!
- 2. Make sure that a clearance of at least 60mm exists above and 80mm below the middle of the profile rail.

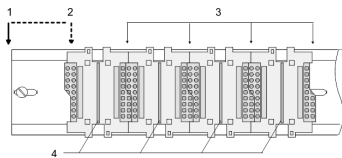

- 1 Head module (double width)
- 2 Head module (single width)
- 3 Periphery modules
- 4 Guide rails

- 1. Every row must be completed from left to right and it has to start with a header module.
- 2. Modules are to be installed side by side. Gaps are not permitted between the modules since this would interrupt the backplane bus.
- 3. A module is only installed properly and connected electrically when it has clicked into place with an audible click.
- 4. Slots after the last module may remain unoccupied.



*A maximum of 32 modules can be connected at the back plane bus. Take attention that here the maximum **sum current** of **3.5A** is not exceeded!*

Mounting procedure

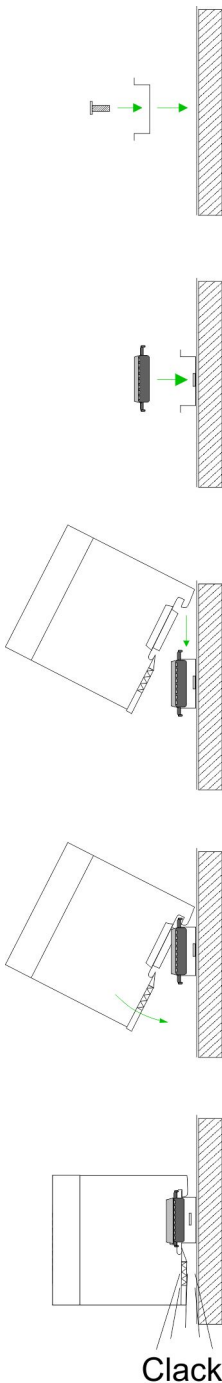

1. ▶ Install the profile rail. Make sure that a clearance of at least 60mm exists above and 80mm below the middle of the profile rail.
2. ▶ Press the bus connector into the profile rail until it clips securely into place and the bus-connectors look out from the profile rail. This provides the basis for the installation of your modules.

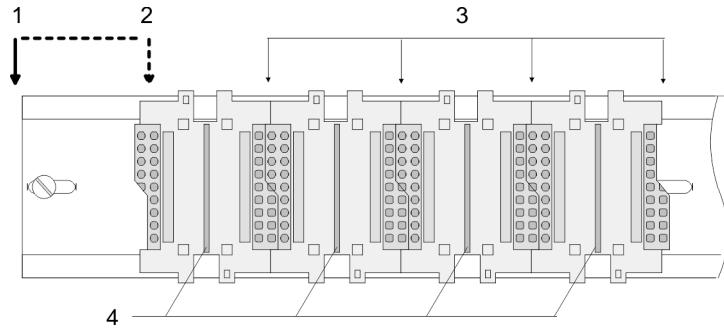

- 1 Head module (double width)
 - 2 Head module (single width)
 - 3 Periphery modules
 - 4 Guide rails
3. ▶ Start at the outer left location with the installation of your header module and install the peripheral modules to the right of this.
 4. ▶ Insert the module that you are installing into the profile rail at an angle of 45 degrees from the top and rotate the module into place until it clicks into the profile rail with an audible click. The proper connection to the backplane bus can only be guaranteed when the module has properly clicked into place.



CAUTION!

Power must be turned off before modules are installed or removed!

2.5 Demounting and module exchange

Demounting

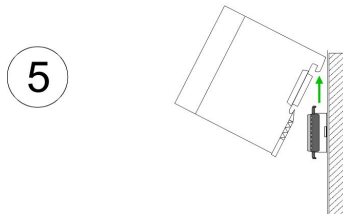
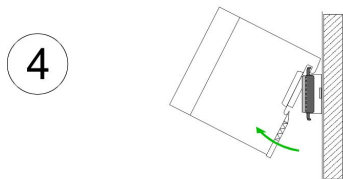
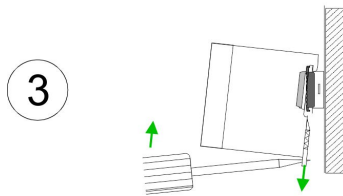
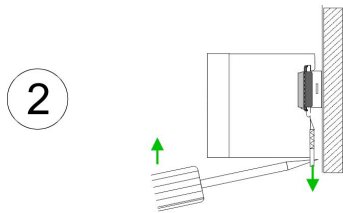
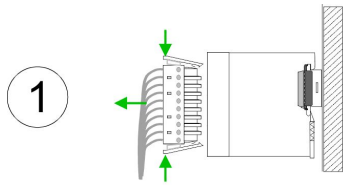

1. ➤ Remove if exists the wiring to the module, by pressing both locking lever on the connector and pulling the connector.
2. ➤ The casing of the module has a spring loaded clip at the bottom by which the module can be removed. Insert as shown, a screwdriver into the clip.
3. ➤ The clip is unlocked by pressing the screwdriver in an upward direction.
4. ➤ Pull the module.
5. ➤ Withdraw the module with a slight rotation to the top.



CAUTION!

Power must be turned off before modules are installed or removed!

Please regard that the backplane bus is interrupted at the point where the module was removed!

2.6 Wiring

Overview

Most of the periphery modules are equipped with a 10pin respectively 18pin connector. This connector provides the electrical interface for the signalling and supplies lines of the modules. Terminals with spring clamp technology are used for wiring. The spring clamp technology allows quick and easy connection of your signal and supply lines. In contrast to screw terminal connections this type of connection is vibration proof. The pin assignment of the periphery modules can be found in the description of the modules. You can use wires with a cross section of 0.08mm^2 up to 2.5mm^2 (up to 1.5mm^2 for 18pin connectors). The figure shows a module with a 10pole connector:

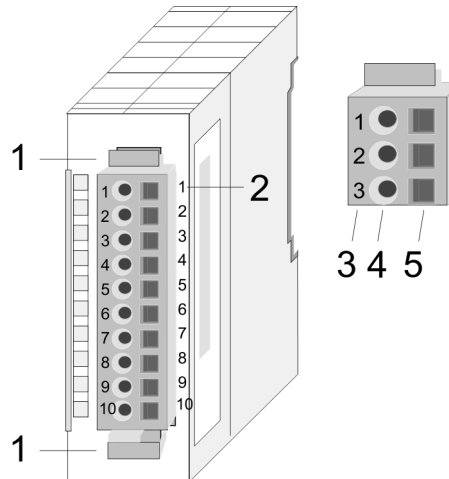

- 1 Locking lever
- 2 Pin no. at the module
- 3 Pin no. at the connector
- 4 Wiring port
- 5 Opening for screwdriver



The spring-clip is destroyed if you push the screwdriver into the wire port! Make sure that you only insert the screwdriver into the square hole of the connector!

Wiring procedure

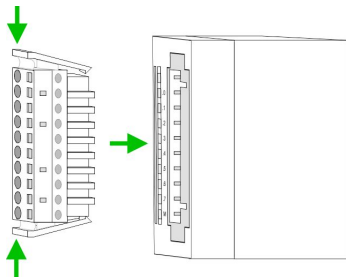

1. ▶ Install the connector on the module until it locks with an audible click. For this purpose you press the two clips together as shown.
 - ⇒ The connector is now in a permanent position and can easily be wired.

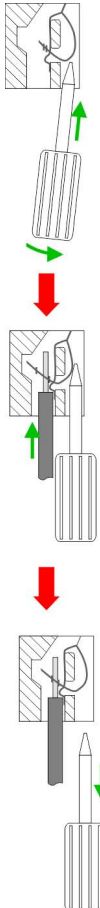

2. ▶ The following section shows the wiring procedure from top view. Insert a suited screwdriver at an angle into the square opening as shown.
3. ▶ Press and hold the screwdriver in the opposite direction to open the contact spring.
4. ▶ Insert the stripped end of wire into the round opening. You can use wires with a cross section of 0.08mm² up to 2.5mm² (1.5mm² for 18pin connectors).
5. ▶ By removing the screwdriver, the wire is securely fixed via the spring contact to the connector.



Wire the power supply connections first followed by the signal cables (inputs and outputs).

2.7 Installation guidelines

General

The installation guidelines contain information about the interference free deployment of a PLC system. There is the description of the ways, interference may occur in your PLC, how you can make sure the electromagnetic compatibility (EMC), and how you manage the isolation.

What does EMC mean?

Electromagnetic compatibility (EMC) means the ability of an electrical device, to function error free in an electromagnetic environment without being interfered respectively without interfering the environment.

The components of VIPA are developed for the deployment in industrial environments and meets high demands on the EMC. Nevertheless you should project an EMC planning before installing the components and take conceivable interference causes into account.

Possible interference causes

Electromagnetic interferences may interfere your control via different ways:

- Electromagnetic fields (RF coupling)
- Magnetic fields with power frequency
- Bus system
- Power supply
- Protected earth conductor

Depending on the spreading medium (lead bound or lead free) and the distance to the interference cause, interferences to your control occur by means of different coupling mechanisms.

There are:

- galvanic coupling
- capacitive coupling
- inductive coupling
- radiant coupling

Basic rules for EMC

In the most times it is enough to take care of some elementary rules to guarantee the EMC. Please regard the following basic rules when installing your PLC.

- Take care of a correct area-wide grounding of the inactive metal parts when installing your components.
 - Install a central connection between the ground and the protected earth conductor system.
 - Connect all inactive metal extensive and impedance-low.
 - Please try not to use aluminium parts. Aluminium is easily oxidizing and is therefore less suitable for grounding.
- When cabling, take care of the correct line routing.
 - Organize your cabling in line groups (high voltage, current supply, signal and data lines).
 - Always lay your high voltage lines and signal respectively data lines in separate channels or bundles.
 - Route the signal and data lines as near as possible beside ground areas (e.g. suspension bars, metal rails, tin cabinet).
- Proof the correct fixing of the lead isolation.
 - Data lines must be laid isolated.
 - Analog lines must be laid isolated. When transmitting signals with small amplitudes the one sided laying of the isolation may be favourable.
 - Lay the line isolation extensively on an isolation/protected earth conductor rail directly after the cabinet entry and fix the isolation with cable clamps.
 - Make sure that the isolation/protected earth conductor rail is connected impedance-low with the cabinet.
 - Use metallic or metallised plug cases for isolated data lines.

- In special use cases you should appoint special EMC actions.
 - Consider to wire all inductivities with erase links.
 - Please consider luminescent lamps can influence signal lines.
- Create a homogeneous reference potential and ground all electrical operating supplies when possible.
 - Please take care for the targeted employment of the grounding actions. The grounding of the PLC serves for protection and functionality activity.
 - Connect installation parts and cabinets with your PLC in star topology with the isolation/protected earth conductor system. So you avoid ground loops.
 - If there are potential differences between installation parts and cabinets, lay sufficiently dimensioned potential compensation lines.

Isolation of conductors

Electrical, magnetically and electromagnetic interference fields are weakened by means of an isolation, one talks of absorption. Via the isolation rail, that is connected conductive with the rack, interference currents are shunt via cable isolation to the ground. Here you have to make sure, that the connection to the protected earth conductor is impedance-low, because otherwise the interference currents may appear as interference cause.

When isolating cables you have to regard the following:

- If possible, use only cables with isolation tangle.
- The hiding power of the isolation should be higher than 80%.
- Normally you should always lay the isolation of cables on both sides. Only by means of the both-sided connection of the isolation you achieve high quality interference suppression in the higher frequency area. Only as exception you may also lay the isolation one-sided. Then you only achieve the absorption of the lower frequencies. A one-sided isolation connection may be convenient, if:
 - the conduction of a potential compensating line is not possible.
 - analog signals (some mV respectively μA) are transferred.
 - foil isolations (static isolations) are used.
- With data lines always use metallic or metallised plugs for serial couplings. Fix the isolation of the data line at the plug rack. Do not lay the isolation on the PIN 1 of the plug bar!
- At stationary operation it is convenient to strip the insulated cable interruption free and lay it on the isolation/protected earth conductor line.
- To fix the isolation tangles use cable clamps out of metal. The clamps must clasp the isolation extensively and have well contact.
- Lay the isolation on an isolation rail directly after the entry of the cable in the cabinet. Lead the isolation further on to your PLC and don't lay it on there again!



CAUTION!

Please regard at installation!

At potential differences between the grounding points, there may be a compensation current via the isolation connected at both sides.

Remedy: Potential compensation line

2.8 General data

Reliability

- Wiring by means of spring pressure connections (CageClamps) at the front-facing connector, core cross-section 0.08 ... 2.5mm² or 1.5 mm² (18pole plug)
- Complete isolation of the wiring when modules are exchanged
- Every module is isolated from the backplane bus

General data

Conformity and approval		
Conformity		
CE	2014/35/EU	Low-voltage directive
	2014/30/EU	EMC directive
Approval		
UL	UL 508	Approval for USA and Canada
others		
RoHS	2011/65/EU	Product is lead-free; Restriction of the use of certain hazardous substances in electrical and electronic equipment

Protection of persons and device protection		
Type of protection	-	IP20
Electrical isolation		
to the field bus	-	electrically isolated
to the process level	-	electrically isolated
Insulation resistance		-
Insulation voltage to reference earth		
Inputs / outputs	-	AC / DC 50V, test voltage AC 500V
Protective measures	-	against short circuit

Environmental conditions to EN 61131-2		
Climatic		
Storage / transport	EN 60068-2-14	-25...+70°C
Operation		
Horizontal installation hanging	EN 61131-2	0...+60°C
Horizontal installation lying	EN 61131-2	0...+40°C
Vertical installation	EN 61131-2	0...+40°C
Air humidity	EN 60068-2-30	RH1 (without condensation, rel. humidity 10... 95%)
Pollution	EN 61131-2	Degree of pollution 2

General data

Environmental conditions to EN 61131-2

Installation altitude max.	-	2000m
Mechanical		
Oscillation	EN 60068-2-6	1g, 9Hz ... 150Hz
Shock	EN 60068-2-27	15g, 11ms

Mounting conditions

Mounting place	-	In the control cabinet
Mounting position	-	Horizontal hanging, lying horizontally and vertical

EMC	Standard	Comment	
Emitted interference	EN 61000-6-4	Class A (Industrial area)	
Noise immunity zone B	EN 61000-6-2	Industrial area	
		EN 61000-4-2	ESD 8kV at air discharge (degree of severity 3), 4kV at contact discharge (degree of severity 2)
		EN 61000-4-3	HF field immunity (casing) 80MHz ... 1000MHz, 10V/m, 80% AM (1kHz) 1.4GHz ... 2.0GHz, 3V/m, 80% AM (1kHz) 2GHz ... 2.7GHz, 1V/m, 80% AM (1kHz)
		EN 61000-4-6	HF conducted 150kHz ... 80MHz, 10V, 80% AM (1kHz)
		EN 61000-4-4	Burst, degree of severity 3
		EN 61000-4-5	Surge, installation class 3 *

*) Due to the high-energetic single pulses with Surge an appropriate external protective circuit with lightning protection elements like conductors for lightning and overvoltage is necessary.

3 Hardware description

3.1 Properties

CPU 215-2BT16

- Instruction set compatible with Siemens STEP®7
- Configuration by means of the Siemens SIMATIC manager or TIA Portal
- Integrated V-Bus controller for controlling System 200V peripherals
- Integrated 24V power supply
- Total address range: 1024Byte inputs, 1024Byte outputs (128Byte process image each)
- 128kByte of work memory "on board"
- 192kByte of load memory "on board"
- MMC slot (for user program)
- Battery backed clock
- MP²I interface for data transfer
- Status LEDs for operating mode and diagnostics
- Integrated Ethernet CP 243 (compatible to CP 343)
 - Direct connection to twisted pair Ethernet via RJ45 jack
 - CP configurable with NetPro from Siemens
 - Protocols: TCP/IP, UDP and RFC1006
 - Transfer rate 10/100MBit/s
 - PG/OP channel

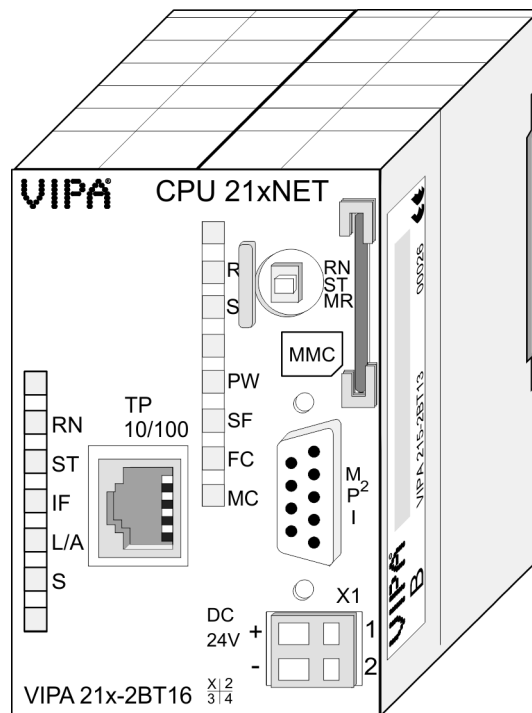

Ordering data

Type	Order number	Description
CPU 215PG	215-2BT16	CPU with Ethernet PG/OP channel and 128/192kByte of work/load memory

3.2 Structure

3.2.1 General

CPU 215-2BT16

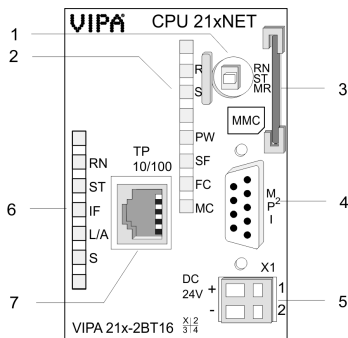

- 1 Operating mode switch
- 2 LEDs of the CPU
- 3 Slot for MMC memory card
- 4 MP²I interface
- 5 Slot for DC 24V power supply
- 6 LEDs of the CP 243 respectively Ethernet PG/OP channel
- 7 Ethernet interface for CP 243 respectively Ethernet PG/OP channel

3.2.2 Interfaces

MP²I

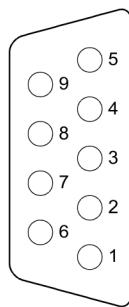

- ① reserved
- ② M24V
- ③ RxD/TxD-P (line B)
- ④ RTS
- ⑤ M5V
- ⑥ P5V
- ⑦ P24V
- ⑧ RxD/TxD-N (line A)
- ⑨ n.c.

RJ45

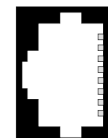

- ① Transmit +
- ② Transmit -
- ③ Receive +
- ④ -
- ⑤ -
- ⑥ Receive -
- ⑦ -
- ⑧ -

X1

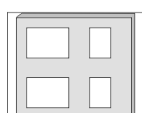

- + ① + DC 24 V
- ② 0 V

Power supply

The CPU has an internal power supply. This is connected to an external supply voltage via two terminals located on the front of the unit.

- The power supply requires DC 24V. In addition to the electronic circuitry of the CPU this supply voltage is used for the modules connected to the backplane bus.
- The electronic circuitry of the CPU is not dc-insulated from the supply voltage. The power supply is protected against reverse polarity and short circuits.



Please ensure that the polarity of the supply voltage is correct.

MP²I interface

- The MPI unit provides the link for the data transfer between the CPU and the PC.
- Via bus communication you are able to exchange program and data between different CPUs that are linked over MPI.
- For a serial exchange between the partners you normally need a special MPI-converter. But now you are also able to use the VIPA "Green Cable" order number: 950-0KB00
- This allows you to establish a serial peer-to-peer connection with VIPA system components over the MPI interface.
- Please regard the  *'Hints for the deployment of the MPI interface' on page 38.*

Ethernet interface

8pin RJ45 jack:

- The CP 243 offers you a communication processor
- PG/OP channels (each 1 connection is reserved for PG and OP)
 *'Hardware configuration - Ethernet PG/OP channel' on page 41*
- Productive connections configurable with Siemens NetPro respectively by user program



Number of connections  *'Technical data' on page 30.*

The project engineering happens as CP 343-1EX11. Via the RJ45 jack you may connect the CP 243 to Twisted-Pair-Ethernet.

3.2.3 Memory management**Memory**

The CPU 215-2BT16 has an integrated work memory and a load memory. The memories are battery-buffered.

- 192kbyte load memory
- 128kbyte work memory

3.2.4 Storage media slot

- As external storage medium for applications and firmware you may use a MMC storage module (**M**ultimedia **c**ard) from VIPA (Order number: 953-0KX10).
- The VIPA storage media are pre-formatted with the PC format FAT16 and can be accessed via a card reader.
- After PowerON respectively an overall reset the CPU checks, if there is a storage medium with data valid for the CPU.
- Push the memory card into the slot until it snaps in leaded by a spring mechanism. This ensures contacting.

3.2.5 Battery backup for clock and RAM

A rechargeable battery is installed on the CPU 215-2BT16 to safeguard the contents of the RAM when power is removed. This battery is also used to buffer the internal clock. The rechargeable battery is maintained by a charging circuit that receives its power from the internal power supply and that maintain the clock and RAM for a max. period of 30 days.



CAUTION!

- Due to a long storage of the CPU, the battery may be discharged excessively. Please connect the CPU at least for 24 hours to the power supply, to achieve the full buffer capacity.
- After a power reset and with an empty battery the CPU starts with a BAT error and executes an overall reset, because with an empty battery the RAM content is undefined.

3.2.6 Operating mode switch

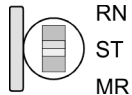





- With the operating mode switch you may switch the CPU between STOP and RUN.
- During the transition from STOP to RUN the operating mode START-UP is driven by the CPU.
- By Switching to MR (Memory Reset) you request an overall reset with following load from MMC, if a project there exists.

3.2.7 LEDs

LEDs CPU





As soon as the CPU is supplied with 5V, the green PW-LED (Power) is on.

R (RUN)	S (STOP)	SF (SFAIL)	FC (FRCE)	MC (MMC)	Meaning
green 	yellow 	red 	yellow 	yellow 	
○	●	X	X	X	CPU is in STOP state.
B	○	X	X	X	CPU is in start-up state, the RUN LED blinks during operating OB100 at least for 3s.
●	○	○	X	X	CPU is in state RUN without error.
X	X	●	X	X	There is a system fault. More information may be found in the diagnostics buffer of the CPU.
X	X	X	●	X	Variables are forced.
X	X	X	X	B	Access to the memory card.
Overall reset					
○	B	X	X	X	Overall reset is executed.
○	●	X	X	X	Overall reset finished.
Factory reset					
●	●	○	○	○	Factory reset is executed.
○	●	○	○	○	Factory reset finished without error.
Firmware update					
○	○	B	B	●	The alternate blinking indicates that there is new firmware on the memory card.
○	●	●	●	●	Firmware update finished without error.
○	B	B	B	B	Blinking: Error during Firmware update.
on: ● off: ○ blinking: B not relevant: X					

Technical data

LEDs CP 243

In addition the CPU has more LEDs that display the communication of the CP. The LEDs are located on the front of the left side of the housing.

Name	Color	Description
RN (RUN)	green 	● CP project is loaded
		○ CP is reset (no project)
ST (STOP)	yellow 	● CP status is reset
		○ CP Project is transferred
IF (Internal error)	red 	● Internal CP error
L/A (Link/Activity)	green 	● Physically connected to Ethernet
		○ No physical connection to Ethernet
		B Irregular flashing: Ethernet activity
S (Speed)	green 	● Transfer speed: 100MBit/s
		○ Transfer speed: 10MBit/s

on: ● | off: ○ | blinking: B

3.3 Technical data

Order no.	215-2BT16
Type	CPU 215NET
Technical data power supply	
Power supply (rated value)	DC 24 V
Power supply (permitted range)	DC 20.4...28.8 V
Reverse polarity protection	✓
Current consumption (no-load operation)	140 mA
Current consumption (rated value)	1.5 A
Inrush current	65 A
I ² t	0.75 A ² s
Max. current drain at backplane bus	3 A
Max. current drain load supply	-
Power loss	6 W
Load and working memory	
Load memory, integrated	192 KB
Load memory, maximum	192 KB
Work memory, integrated	128 KB

Order no.	215-2BT16
Work memory, maximal	128 KB
Memory divided in 50% program / 50% data	-
Memory card slot	MMC-Card with max. 512 MB
Hardware configuration	
Racks, max.	4
Modules per rack, max.	total max. 32
Number of integrated DP master	-
Number of DP master via CP	8
Operable function modules	32
Operable communication modules PtP	32
Operable communication modules LAN	-
Command processing times	
Bit instructions, min.	0.18 μ s
Word instruction, min.	0.78 μ s
Double integer arithmetic, min.	1.8 μ s
Floating-point arithmetic, min.	40 μ s
Timers/Counters and their retentive characteristics	
Number of S7 counters	256
S7 counter remanence	adjustable 0 up to 255
S7 counter remanence adjustable	C0 .. C7
Number of S7 times	256
S7 times remanence	adjustable 0 up to 255
S7 times remanence adjustable	not retentive
Data range and retentive characteristic	
Number of flags	8192 Bit
Bit memories retentive characteristic adjustable	adjustable 0 up to 1023
Bit memories retentive characteristic preset	MB0 .. MB15
Number of data blocks	2047
Max. data blocks size	16 KB
Number range DBs	1 ... 2047
Max. local data size per execution level	1024 Byte
Max. local data size per block	1024 Byte
Blocks	
Number of OBs	14
Maximum OB size	16 KB

Technical data

Order no.	215-2BT16
Total number DBs, FBs, FCs	-
Number of FBs	1024
Maximum FB size	16 KB
Number range FBs	0 ... 1023
Number of FCs	1024
Maximum FC size	16 KB
Number range FCs	0 ... 1023
Maximum nesting depth per priority class	8
Maximum nesting depth additional within an error OB	1
Time	
Real-time clock buffered	✓
Clock buffered period (min.)	30 d
Type of buffering	Vanadium Rechargeable Lithium Battery
Load time for 50% buffering period	20 h
Load time for 100% buffering period	48 h
Accuracy (max. deviation per day)	10 s
Number of operating hours counter	8
Clock synchronization	-
Synchronization via MPI	-
Synchronization via Ethernet (NTP)	-
Address areas (I/O)	
Input I/O address area	1024 Byte
Output I/O address area	1024 Byte
Process image adjustable	-
Input process image preset	128 Byte
Output process image preset	128 Byte
Input process image maximal	128 Byte
Output process image maximal	128 Byte
Digital inputs	8192
Digital outputs	8192
Digital inputs central	512
Digital outputs central	512
Integrated digital inputs	-
Integrated digital outputs	-
Analog inputs	512

Order no.	215-2BT16
Analog outputs	512
Analog inputs, central	128
Analog outputs, central	128
Integrated analog inputs	-
Integrated analog outputs	-
Communication functions	
PG/OP channel	✓
Global data communication	✓
Number of GD circuits, max.	4
Size of GD packets, max.	22 Byte
S7 basic communication	✓
S7 basic communication, user data per job	76 Byte
S7 communication	✓
S7 communication as server	✓
S7 communication as client	-
S7 communication, user data per job	160 Byte
Number of connections, max.	16
Functionality Sub-D interfaces	
Type	MP ² I
Type of interface	RS485
Connector	Sub-D, 9-pin, female
Electrically isolated	-
MPI	✓
MP ² I (MPI/RS232)	✓
Point-to-point interface	-
5V DC Power supply provided	max. 90mA, non-isolated
24V DC Power supply provided	max. 100mA, non-isolated
Functionality MPI	
Number of connections, max.	16
PG/OP channel	✓
Routing	-
Global data communication	✓
S7 basic communication	✓
S7 communication	✓
S7 communication as server	✓
S7 communication as client	-

Technical data

Order no.	215-2BT16
Transmission speed, min.	19.2 kbit/s
Transmission speed, max.	187.5 kbit/s
Functionality RJ45 interfaces	
Type	TP
Type of interface	Ethernet 10/100 MBit
Connector	RJ45
Electrically isolated	✓
PG/OP channel	✓
Number of connections, max.	8
Productive connections	✓
Ethernet communication CP	
Number of productive connections, max.	16
Number of productive connections by Siemens NetPro, max.	16
S7 connections	-
User data per S7 connection, max.	-
TCP-connections	SEND, RECEIVE, FETCH PASSIV, WRITE PASSIV, Connection of active and passive data handling
User data per TCP connection, max.	64 KB
ISO-connections	SEND and RECEIVE
User data per ISO connection, max.	8 KB
ISO on TCP connections (RFC 1006)	SEND, RECEIVE, FETCH PASSIV, WRITE PASSIV, Connection of active and passive data handling
User data per ISO on TCP connection, max.	32 KB
UDP-connections	SEND and RECEIVE
User data per UDP connection, max.	2 KB
UDP-multicast-connections	SEND and RECEIVE (max. 16 Multicast groups)
UDP-broadcast-connections	SEND
Datasizes	
Input bytes	0
Output bytes	0
Parameter bytes	3
Diagnostic bytes	0
Housing	
Material	PPE / PA 6.6

Order no.	215-2BT16
Mounting	Profile rail 35 mm
Mechanical data	
Dimensions (WxHxD)	50.8 mm x 76 mm x 80 mm
Weight	150 g
Environmental conditions	
Operating temperature	0 °C to 60 °C
Storage temperature	-25 °C to 70 °C
Certifications	
UL certification	in preparation
KC certification	-

4 Deployment

4.1 Assembly



Information about assembly and cabling: ↪ 'Mounting' on page 13

4.2 Start-up behavior

Turn on power supply

When the CPU is delivered it has been reset. After the power supply has been switched on, the CPU changes to the operating mode the operating mode lever shows. After a STOP → RUN transition the CPU switches to RUN without program.



Due to a long storage of the CPU, the battery may be discharged excessively. Please connect the CPU at least for 24 hours to the power supply, to achieve the full buffer capacity.

Boot procedure with valid data in the CPU

The CPU switches to RUN with the program stored in the battery buffered RAM.

Boot procedure with empty battery

- The accumulator/battery is automatically loaded via the integrated power supply and guarantees a buffer for max. 30 days. If this time is exceeded, the battery may be totally discharged. This means that the battery buffered RAM is deleted.
- In this state, the CPU executes an overall reset because with an empty battery the RAM content is undefined. If a MMC with a S7PROG.WLD is plugged, program code and data blocks are transferred from the MMC into the work memory of the CPU.
- If there is no MMC, the project from the internal Flash is loaded.
- Depending on the position of the operating mode switch, the CPU remains in STOP respectively switches to RUN. Due to the battery error the CPU can only boot if there was an OB81 configured. Otherwise a manual restart (STOP/RUN) respectively PG command is necessary.
- On a start-up with an empty battery the SF LED is on and thus points to an entry in the diagnostic buffer.
↪ 'Diagnostic entries' on page 56



CAUTION!

After a power reset and with an empty battery the CPU starts with a BAT error and executes an overall reset.

4.3 Addressing

Automatic addressing

To provide specific addressing of the installed peripheral modules, certain addresses must be allocated in the CPU. The CPU contains a peripheral area (addresses 0 ... 1023) and a process image of the inputs and the outputs (for both each address 0 ... 127). When the CPU is initialized it automatically assigns peripheral addresses to the digital input/output modules starting from 0. If there is no hardware projecting, analog modules are allocated to even addresses starting from address 128.

Signaling states in the process image

The signaling states of the lower addresses (0 ... 127) are additionally saved in a special memory area called the *process image*.

The process image is divided into two parts:

- process image of the inputs (PII)
- process image of the outputs (PIQ)

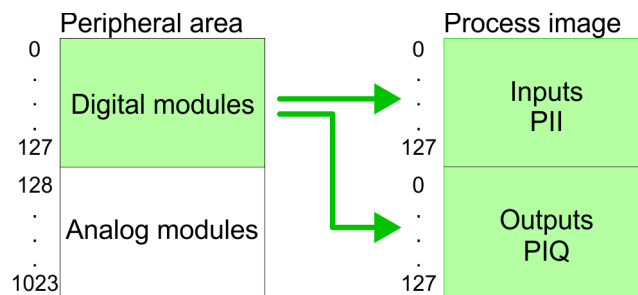

The process image is updated automatically when a cycle has been completed.

Read/write access

You may access the modules by means of read or write operations on the peripheral bytes or on the process image.



Please remember that you may access different modules by means of read and write operations on the same address.

The addressing ranges of digital and analog modules are different when they are addressed automatically.

- Digital modules: 0 ... 127
- Analog modules: 128 ... 1023

Example for automatic address allocation

The following figure illustrates the automatic allocation of addresses:

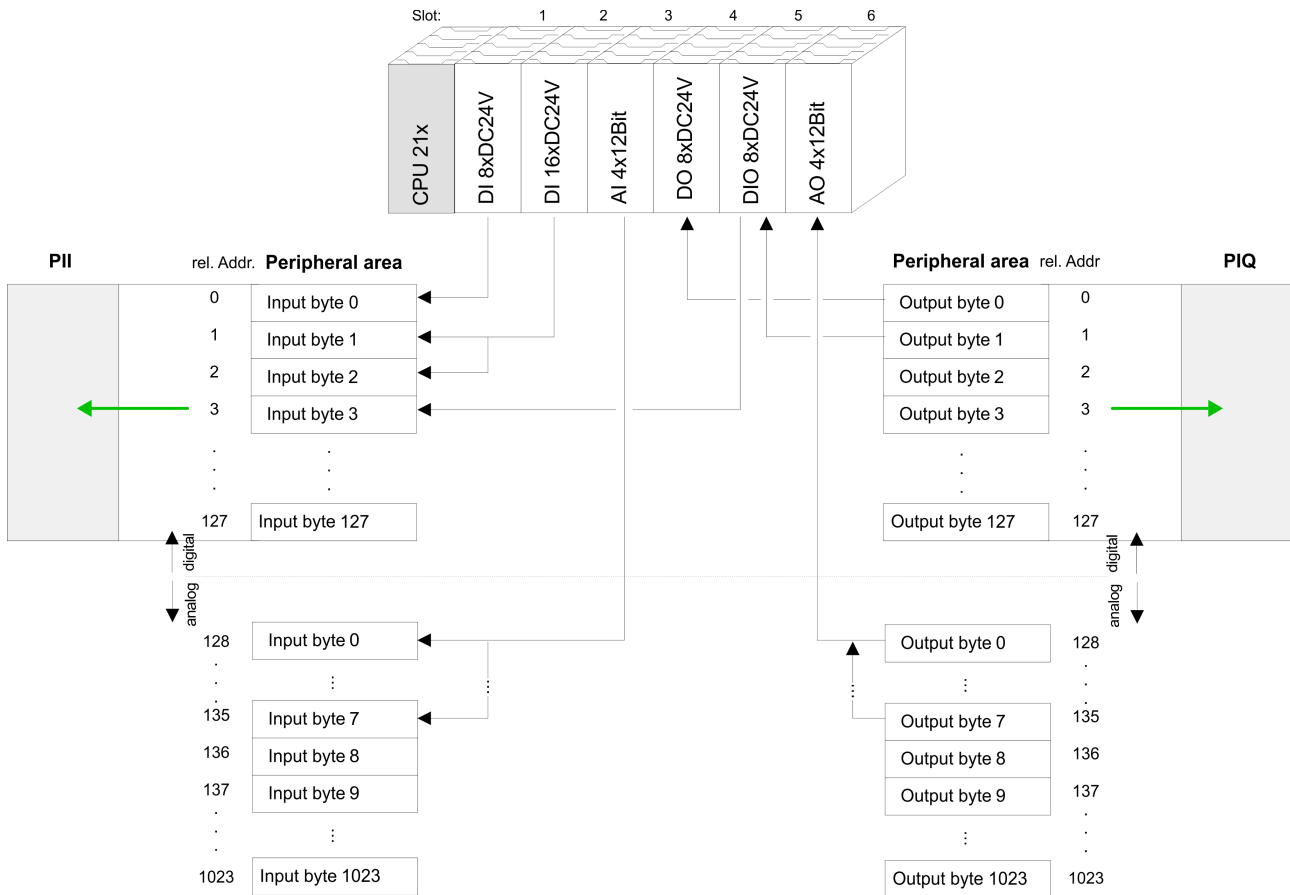

Modifying allocated addresses by configuration

You may change the allocated addresses at any time by means of the Siemens SIMATIC manager. In this way you may also change the addresses of analog modules to the range covered by the process image (0 ... 127) and address digital modules above 127. The following pages describe the required preparations and the procedure for this type of configuration.

4.4 Hints for the deployment of the MPI interface

What is MP²I?

The MP²I jack combines 2 interfaces in 1:

- MP Interface
- RS232 Interface

Please regard that the RS232 functionality is only available by using the Green Cable from VIPA.

Deployment as MPI

The MPI provides the data transfer between CPUs and PCs. In a bus communication you may transfer program and data between the CPUs interconnected via MPI. Connecting a common MPI cable, the MPI jack supports the full MPI functionality.

**CAUTION!****Important notes for the deployment of MPI cables!**

Deploying MPI cables at the CPUs from VIPA, you have to make sure that Pin 1 is not connected. This may cause transfer problems and in some cases damage the CPU! Especially PROFIBUS cables from Siemens, like e.g. the 6XV1 830-1CH30, must not be deployed at MP²I jack. For damages caused by nonobservance of these notes and at improper deployment, VIPA does not take liability!

Deployment as RS232 interface only via "Green Cable"



For the serial data transfer from your PC, you normally need a MPI transducer. Fortunately you may also use the "Green Cable" from VIPA. You can order this under the order no. VIPA 950-0KB00.

The "Green Cable" supports a serial point-to-point connection for data transfer via the MP²I jack exclusively for VIPA CPUs.

4.5 Hardware configuration - CPU

Overview

For the project engineering of the CPU 215-2BT16 and the other System 200V modules connected to the same VIPA bus, the hardware configurator from Siemens is to be used. To address the directly plugged peripheral modules, you have to assign a special address in the CPU to every module. The address allocation and the parameterization of the modules takes place in the Siemens SIMATIC manager as a virtual PROFIBUS system. For the PROFIBUS interface is standardized software sided, the functionality is guaranteed by including a GSD-file into the Siemens SIMATIC manager. Transfer your project into the CPU via the MPI interface.

Requirements

The following conditions must be fulfilled for project engineering:

- The Siemens SIMATIC manager is installed at PC respectively PG
- The GSD files have been included in Siemens hardware configurator
- Serial connection to the CPU (e.g. MPI-Adapter)



The configuration of the CPU requires a thorough knowledge of the Siemens SIMATIC manager and the hardware configurator!

Including the GSD-file

1. ➤ Go to www.vipa.com > Service > Download > PROFIBUS GSD files and download the file *System_100V_-_200V_Vxxx.zip*.
2. ➤ Extract the file to your work directory. The *vipa_21x.gsd* (German) respectively *vipa_21x.gse* (English) can be found at the directory *CPU21x*.
3. ➤ Start the Siemens hardware configurator and close every project.
4. ➤ Go to **Options** > *Install new GSD file*.
5. ➤ Navigate to the directory *CPU21x* and choose the corresponding file **vipa_21x.gsd** (German) or **vipa_21x.gse** (English)
 - ⇒ Now the modules of the VIPA System 200V are integrated in the *hardware catalog* at *PROFIBUS-DP \ Additional field devices \ I/O \ VIPA_System_200V*.

Proceeding

To be compatible with the Siemens SIMATIC manager the following steps should be executed:

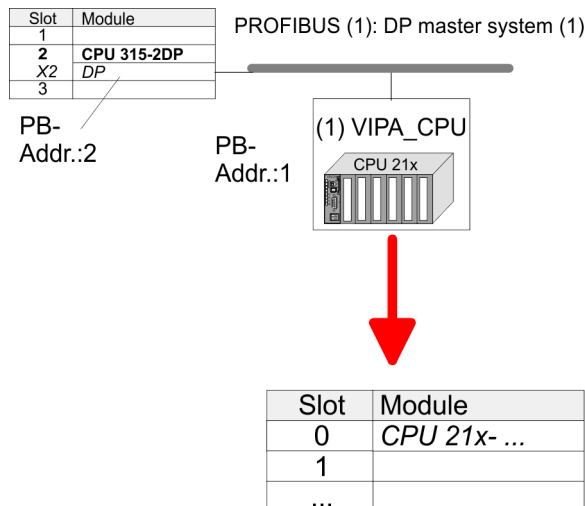

1. ➤ Start the hardware configurator from Siemens with a new project.
2. ➤ Insert a profile rail from the hardware catalog.
3. ➤ Place at slot 2 the following CPU from Siemens CPU 315-2DP (6ES7 315-2AG10-0AB0 V2.6.)
4. ➤ For the System 200V create a new PROFIBUS subnet.
5. ➤ Attach the slave system "VIPA_CPU21x" to the subnet with **PROFIBUS-Address 1**
 - ⇒ After installing the *vipa_21x.gsd* the slave system may be found at the hardware catalog at *PROFIBUS DP > Additional field devices > IO > VIPA_System_200V*.
6. ➤ Place always at the **1. slot** the corresponding 215-2BT16, by taking it from the hardware catalog.

4.6 Hardware configuration - I/O modules

Hardware configuration of the modules

After the hardware configuration of the CPU place the System 200V modules in the plugged sequence. In order to address the installed peripheral modules individually, specific addresses in the CPU have to be assigned to them.

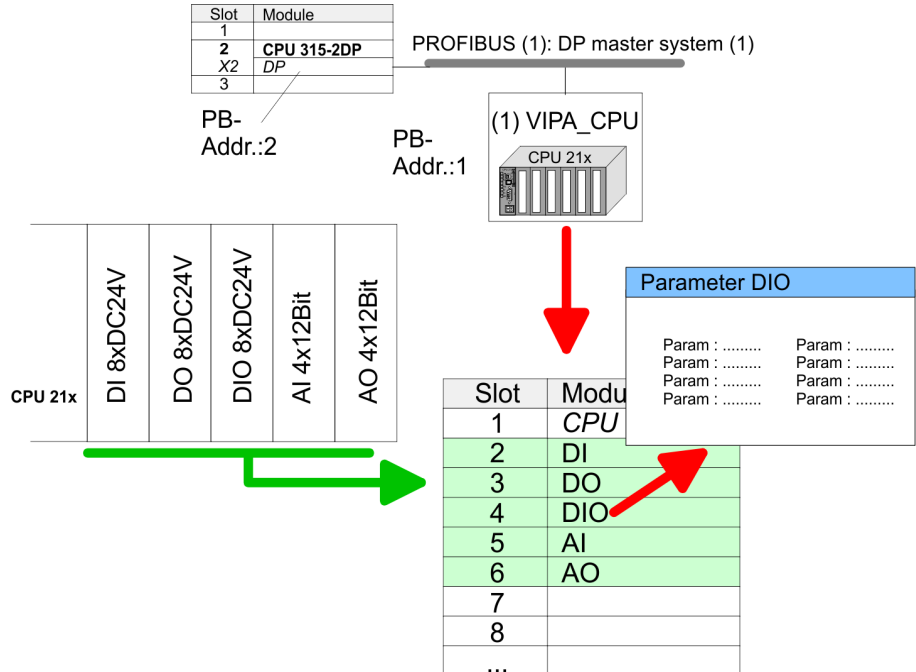

Parameterization

For parameterization double-click during the project engineering at the slot overview on the module you want to parameterize. In the appearing dialog window you may set the wanted parameters.

Parameterization during runtime

By using the SFCs 55, 56 and 57 you may alter and transfer parameters for wanted modules during runtime. For this you have to store the module specific parameters in so called "record sets". More detailed information about the structure of the record sets is to find in the according module description.

4.7 Hardware configuration - Ethernet PG/OP channel

Overview

The CPU has an integrated Ethernet PG/OP channel. This channel allows you to program and remote control your CPU. With the first start-up respectively after an overall reset the Ethernet PG/OP channel does not have any IP address. For online access to the CPU via Ethernet PG/OP channel valid IP address parameters have to be assigned to this by means of the Siemens SIMATIC manager. This is called "initialization".

Assembly and commissioning

1. ▶ Install your System 200V with your CPU.
2. ▶ Wire the system by connecting cables for voltage supply and signals.

3. ➤ Connect the Ethernet jack of the Ethernet PG/OP channel to Ethernet.
4. ➤ Switch on the power supply.
 - ⇒ After a short boot time the CP is ready for communication. He possibly has no IP address data and requires an initialization.

"Initialization" via PLC functions

The initialization via PLC functions takes place with the following proceeding:

- Determine the current Ethernet (MAC) address of your Ethernet PG/OP channel.
 - ⇒ This always may be found at a sticker on the left side of the CPU.

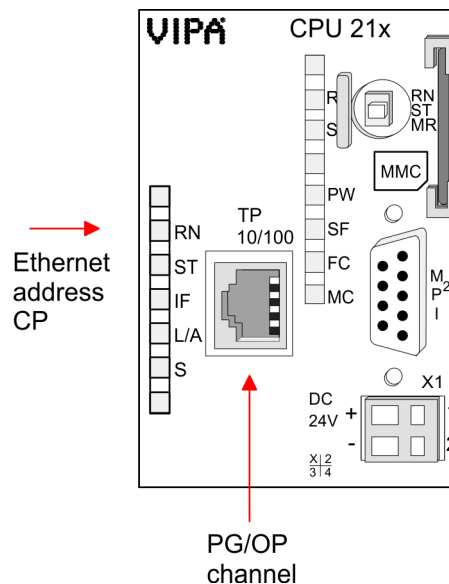

Assign IP address parameters

You get valid IP address parameters from your system administrator. The assignment of the IP address data happens online in the Siemens SIMATIC manager starting with version V 5.3 & SP3 with the following proceeding:

1. ➤ Start the Siemens SIMATIC manager and set via **Options** > Set PG/PC interface the access path to "TCP/IP -> Network card".
2. ➤ Open with **PLC** > Edit Ethernet Node the dialog window with the same name.
3. ➤ To get the stations and their MAC address, use the [Browse] button or type in the MAC Address. The Mac address may be found at the 1. label beneath the front flap of the CPU.
4. ➤ Choose if necessary the known MAC address of the list of found stations.

5. ▶ Either type in the IP configuration like IP address, subnet mask and gateway. Or your station is automatically provided with IP parameters by means of a DHCP server. Depending of the chosen option the DHCP server is to be supplied with MAC address, equipment name or client ID. The client ID is a numerical order of max. 63 characters. The following characters are allowed: "hyphen", 0-9, a-z, A-Z
6. ▶ Confirm with [Assign IP configuration].



Direct after the assignment the Ethernet PG/OP channel may be reached online by these address data. The value remains as long as it is reassigned, it is overwritten by a hardware configuration or an factory reset is executed.

Take IP address parameters in project

1. ▶ Open the Siemens hardware configurator and configure the VIPA CPU 215-2BT16 as Siemens CPU 315-2DP (6ES7 315-2AG10-0AB0 V2.6.) which is to be found at SIMATIC 300 \ CPU 300 \ CPU 315-2DP. If needed, parameterize the CPU 315-2DP.
2. ▶ Configure in deputy of your CP the CP 343-1 (343-1EX11) from Siemens at slot 4, to be found at SIMATIC 300 / CP 300 / Industrial Ethernet / CP 343-1.
3. ▶ Open the property window via double-click on the CP 343-1EX11 and enter for the CP at "Properties" the IP address data, which you have assigned before.
4. ▶ Transfer your project.

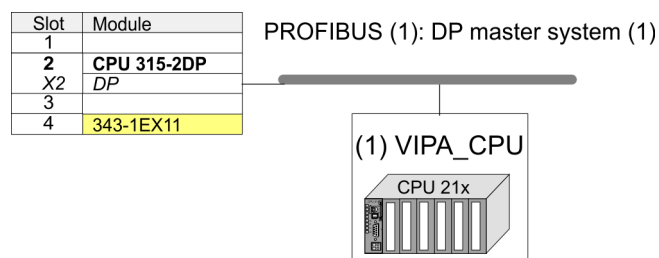

4.8 Setting CPU parameters

Parameterization via Siemens CPU

Since the CPU from VIPA is to be configured as Siemens CPU 315-2DP (6ES7 315-2AG10-0AB0 V2.6.) in the Siemens hardware configurator, the parameters of the VIPA CPU may be set with "Object properties" of the CPU 315-2DP during hardware configuration. Via a double-click on the CPU 315-2DP the parameter window of the CPU may be accessed. Using the registers you get access to every standard parameter of the CPU.

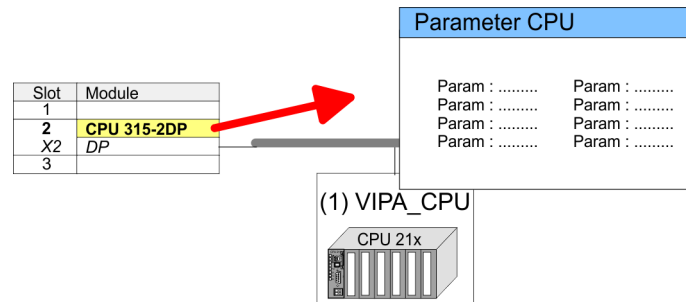

4.8.1 Parameter CPU

Supported parameters

The CPU does not evaluate each parameter, which may be set at the hardware configuration. The following parameters are supported by the CPU at this time:

General

- Short description: Short description Siemens CPU 315-2DP (6ES7 315-2AG10-0AB0 V2.6.).
- Order No. / Firmware: Order number and firmware are identical to the details in the "hardware catalog" window.
- Name: The Name field provides the short description of the CPU. If you change the name the new name appears in the Siemens SIMATIC Manager.
- Plant designation: Here is the possibility to specify a plant designation for the CPU. This plant designation identifies parts of the plant according to their function. Its structure is hierarchic according to IEC 1346-1.
- Comment: In this field information about the module may be entered.

Startup

- Startup when expected/actual configuration differs: If the checkbox for '*Startup when expected/actual configuration differ*' is deselected and at least one module is not located at its configured slot or if another type of module is inserted there instead, then the CPU does not switch to RUN mode and remains in STOP mode. If the checkbox for '*Startup when expected/actual configuration differ*' is selected, then the CPU starts even if there are modules not located in their configured slots or if another type of module is inserted there instead, such as during an initial system start-up.
- Monitoring time for ready message by modules [100ms]: This operation specifies the maximum time for the ready message of every configured module after PowerON. Here connected PROFIBUS DP slaves are also considered until they are parameterized. If the modules do not send a ready message to the CPU by the time the monitoring time has expired, the actual configuration becomes unequal to the preset configuration. Monitoring time for ready message by modules [100ms]
- Transfer of parameters to modules [100ms]: The maximum time for the transfer of parameters to parametrizable modules. If not every module has been assigned parameters by the time this monitoring time has expired; the actual configuration becomes unequal to the preset configuration.

Cycle/Clock memory

- Update OB1 process image cyclically: This parameter is not relevant.
- Scan cycle monitoring time: Here the scan cycle monitoring time in milliseconds may be set. If the scan cycle time exceeds the scan cycle monitoring time, the CPU enters the STOP mode. Possible reasons for exceeding the time are:
 - Communication processes
 - a series of interrupt events
 - an error in the CPU program
- Minimum scan cycle time: This parameter is not relevant.
- Scan cycle load from Communication: This parameter is not relevant.
- Size of the process image input/output area: Here the size of the process image max. 2048 for the input/output periphery may be fixed.
- OB85 call up at I/O access error: The preset reaction of the CPU may be changed to an I/O access error that occurs during the update of the process image by the system. The VIPA CPU is preset such that OB 85 is not called if an I/O access error occurs and no entry is made in the diagnostic buffer either.
- Clock memory: Activate the check box if you want to use clock memory and enter the number of the memory byte.



The selected memory byte cannot be used for temporary data storage.

Retentive Memory

- Number of Memory bytes from MB0: Enter the number of retentive memory bytes from memory byte 0 onwards.
- Number of S7 Timers from T0: Enter the number of retentive S7 timers from T0 onwards. Each S7 timer occupies 2bytes.
- Number of S7 Counters from C0: Enter the number of retentive S7 counter from C0 onwards.
- Areas: This parameter is not supported.

Interrupts

- Priority: Here the priorities are displayed, according to which the hardware interrupt OBs are processed (hardware interrupt, time-delay interrupt, async. error interrupts).

Time-of-day interrupts

- Priority: Here the priorities may be specified according to which the time-of-day interrupt is processed. With priority "0" the corresponding OB is deactivated.
- Active: Activate the check box of the time-of-day interrupt OBs if these are to be automatically started on complete restart.
- Execution: Select how often the interrupts are to be triggered. Intervals ranging from every minute to yearly are available. The intervals apply to the settings made for *start date* and *time*.
- Start date/time: Enter date and time of the first execution of the time-of-day interrupt.
- Process image partition: This parameter is not supported.

Cyclic interrupts

- Priority: Here the priorities may be specified according to which the corresponding cyclic interrupt is processed. With priority "0" the corresponding interrupt is deactivated.
- Execution: Enter the time intervals in ms, in which the watchdog interrupt OBs should be processed. The start time for the clock is when the operating mode switch is moved from STOP to RUN.
- Phase offset: Enter the delay time in ms for current execution for the watch dog interrupt. This should be performed if several watchdog interrupts are enabled. Phase offset allows to distribute processing time for watchdog interrupts across the cycle.
- Process image partition: This parameter is not supported.

Protection

- Level of protection: Here 1 of 3 protection levels may be set to protect the CPU from unauthorized access.
 - *Protection level 1 (default setting):*
No password adjustable, no restrictions
 - *Protection level 2 with password:*
Authorized users: read and write access
Unauthorized user: read access only
 - *Protection level 3:*
Authorized users: read and write access
Unauthorized user: no read and write access

4.9 Project transfer

Overview

There are the following possibilities for project transfer into the CPU:

- Transfer via MPI
- Transfer via Ethernet
- Transfer via MMC when using a MMC programmer

4.9.1 Transfer via MPI

The structure of a MPI net is electrically identical with the structure of a PROFIBUS net. This means the same rules are valid and you use the same components for the build-up. The single participants are connected with each other via bus interface plugs and PROFIBUS cables. Per default the MPI net runs with 187.5kbaud. VIP A CPUs are delivered with MPI address 2.

MPI programming cable

The MPI programming cables are available at VIP A in different variants. The cables provide a RS232 res. USB plug for the PC and a bus enabled RS485 plug for the CPU. Due to the RS485 connection you may plug the MPI programming cables directly to an already plugged plug on the RS485 jack. Every bus participant identifies itself at the bus with an unique address, in the course of the address 0 is reserved for programming devices.

Terminating resistor

A cable has to be terminated with its surge impedance. For this you switch on the terminating resistor at the first and the last participant of a network or a segment. Please make sure that the participants with the activated terminating resistors are always power supplied. Otherwise it may cause interferences on the bus.

Transfer with MPI programming cable (MPI communication)

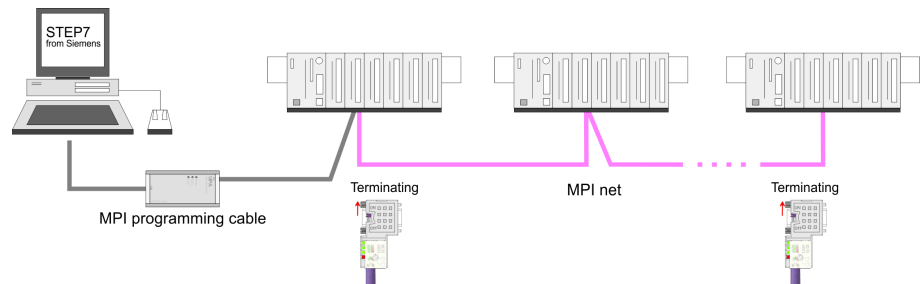

Transfer via "Green Cable" (serial communication)

Via exclusively direct plugging of the "Green Cable" to a MP²I jack you may establish a serial connection between PC and CPU. Set the PC-COM port and the transfer rate 38400Baud at *Local port*. The settings of the register *MPI* are ignored at employment of the "Green Cable".

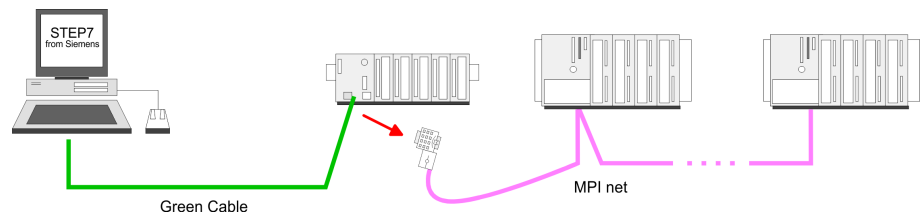

MPI-Programmierkabel

Currently the VIPA programming cables (950-0KBxx) are not supported for transfer via MPI. This is only possible with the programming cable from Siemens. Under Windows® 7 the "Green Cable" (950-0KB00) is not usable.

Configure MPI

Hints for configuring a MPI interface are to find in the documentation of your programming software. The "Green Cable" has the order number: 950-0KB00.



WARNING!

Please regard, that you may use the "Green Cable" exclusively at VIPA CPUs with MP²I-interface! Please regard the hints for deploying the Green Cable and the MP²I jack!

Approach transfer via MPI interface

1. ➤ Connect your PC to the MPI jack of your CPU via a MPI programming cable.
2. ➤ Load your project in the SIMATIC manager from Siemens.
3. ➤ Choose in the menu **Options** > *Set PG/PC interface*
4. ➤ Select in the according list the "PC Adapter (MPI)"; if appropriate you have to add it first, then click on [Properties].
5. ➤ Set in the register *MPI* the transfer parameters of your MPI net and type a valid *address*.

6. ▶ Switch to the register *Local connection*
7. ▶ Set the COM port of the PC and the transfer rate 38400Baud for the MPI programming cable from VIPA.
8. ▶ Via **PLC > Load to module** you may transfer your project via MPI to the CPU and save it on a MMC via **PLC > Copy RAM to ROM** if one is plugged.



Please make sure to adjust the transfer rate to 38400Baud when using the "Green Cable" from VIPA.

Hints for the Green Cable

The Green Cable is a green connection cable, manufactured exclusively for the deployment at VIPA System components. The Green Cable is a programming and download cable for VIPA CPUs MP2I jack and VIPA field bus masters. The Green Cable from VIPA is available under the order no. VIPA 950-0KB00.

The Green Cable allows you to:

- transfer projects serial
 - Avoiding high hardware needs (MPI transducer, etc.) you may realize a serial point-to-point connection via the Green Cable and the MP²I jack. This allows you to connect components to your VIPA-CPU that are able to communicate serial via a MPI adapter like e.g. a visualization system.
- execute firmware updates of the CPUs and field bus masters
 - Via the Green Cable and an upload application you may update the firmware of all recent VIPA CPUs with MP²I jack and certain field bus masters (see Note).



Important notes for the deployment of the Green Cable

Nonobservance of the following notes may cause damages on system components. For damages caused by nonobservance of the following notes and at improper deployment, VIPA does not take liability!



Note to the application area

The Green Cable may exclusively be deployed directly at the concerning jacks of the VIPA components (in between plugs are not permitted). E.g. a MPI cable has to be disconnected if you want to connect a Green Cable. At this time, the following components support Green Cable: VIPA CPUs with MP²I jack and field bus masters from VIPA.



Note to the lengthening

The lengthening of the Green Cable with another Green Cable res. The combination with further MPI cables is not permitted and causes damages of the connected components! The Green Cable may only be lengthened with a 1:1 cable (all 9 pins are connected 1:1).

4.9.2 Transfer via Ethernet

For transfer via Ethernet the CPU has the following interface:

- Ethernet PG/OP channel

Initialization

So that you may access the Ethernet PG/OP channel you have to assign IP address parameters by means of the "initialization".
 ↪ *'Hardware configuration - Ethernet PG/OP channel' on page 41*

Transfer

1. ➤ For the transfer, connect, if not already done, the appropriate Ethernet port to your Ethernet.
2. ➤ Open your project with the Siemens SIMATIC manager.
3. ➤ Set via **Options** > *Set PG/PC Interface* the access path to "TCP/IP -> Network card".
4. ➤ Click to **PLC** > Download
 → the dialog "Select target module" is opened.
 Select your target module and enter the IP address parameters of the Ethernet PG/OP channel for connection. Provided that no new hardware configuration is transferred to the CPU, the entered Ethernet connection is permanently stored in the project as transfer channel.
5. ➤ With [OK] the transfer is started.



System dependent you get a message that the projected system differs from target system. This message may be accepted by [OK].

→ Your project is transferred and may be executed in the CPU after transfer.

4.9.3 Transfer via MMC

The MMC (**M**emory **C**ard) serves as external transfer and storage medium. There may be stored several projects and sub-directories on a MMC storage module. Please regard that your current project is stored in the root directory and has one of the following file names:

- *S7PROG.WLD*
- *S7PROGF.WLD*
- *AUTOLOAD.WLD*

With **File** > *Memory Card File* > *New* in the Siemens SIMATIC manager a new wld file may be created. After the creation copy the blocks from the project blocks folder and the *System data* into the wld file.

Transfer MMC → CPU

The transfer of the application program from the MMC into the CPU takes place depending on the file name after an overall reset or PowerON.

- S7PROG.WLD is read from the MMC after overall reset and transferred into the battery buffered RAM.
- S7PROGF.WLD is read from the MMC after overall reset and transferred into the battery buffered RAM and additionally into the Flash memory. An access to the Flash memory only takes place at empty battery of the buffer and when no MMC with user program is plugged-in.
- AUTOLOAD.WLD is read after PowerON from the MMC and transferred into the battery-buffered RAM .

During the transfer the "MC" LED blinks. Please regard that your user memory serves for enough space, otherwise your user program is not completely loaded and the SF LED gets on. Execute a compression before the transfer, for this does not happen automatically.

Transfer CPU → MMC

When the MMC has been installed, the write command stores the content of the battery buffered RAM as *S7PROG.WLD* on the MMC and in the internal Flash memory. The write command is controlled by means of the block area of the Siemens SIMATIC manager **PLC > Copy RAM to ROM**. During the write process the "MC"-LED of the CPU is blinking. When the LED expires the write process is finished. If this project is to be loaded automatically from the MMC with PowerON, you have to rename this on the MMC to *AUTOLOAD.WLD*.

Transfer control

After a MMC access, an ID is written into the diagnostic buffer of the CPU. To monitor the diagnosis entries, you select **PLC > Module Information** in the Siemens SIMATIC manager. Via the register "Diagnostic Buffer" you reach the diagnosis window. Information about the Event-IDs can be found at "VIPA specific diagnostic entries".

4.10 Operating modes

Overview

The CPU can be in one of 3 operating modes:

- Operating mode STOP
- Operating mode START-UP
- Operating mode RUN

Certain conditions in the operating modes START-UP and RUN require a specific reaction from the system program. In this case the application interface is often provided by a call to an organization block that was included specifically for this event.

Operating mode STOP

- The application program is not processed.
- If there has been a processing before, the values of counters, timers, flags and the process image are retained during the transition to the STOP mode.
- Outputs are inhibited, i.e. all digital outputs are disabled.
- RUN-LED (R) off
- STOP-LED (S) on

Operating mode START-UP

- During the transition from STOP to RUN the system calls the start-up organization block OB 100. The processing time for this OB is not monitored. The start-up OB may issue calls to other blocks.
- All digital outputs are disabled during the start-up, i.e. outputs are inhibited.
- RUN-LED blinks as soon as the OB 100 is operated and for at least 3s, even if the start-up time is shorter or the CPU gets to STOP due to an error. This indicates the start-up.
- STOP-LED off

When the CPU has completed the start-up OB, it assumes the operating mode RUN.

Operating mode RUN

- The application program in OB 1 is processed in a cycle. Under the control of alarms other program sections can be included in the cycle.
- All timers and counters being started by the program are active and the process image is updated with every cycle.
- The BASP-signal (outputs inhibited) is deactivated, i.e. all digital outputs are enabled.
- RUN-LED on
- STOP-LED off

Function security

The CPUs include security mechanisms like a Watchdog (100ms) and a parameterizable cycle time surveillance (parameterizable min. 1ms) that stop res. execute a RESET at the CPU in case of an error and set it into a defined STOP state. The VIPA CPUs are developed function secure and have the following system properties:

Event	concerns	Effect
RUN → STOP	general	BASP (Befehls-Ausgabe-Sperre, i.e. command output lock) is set.
	central digital outputs	The outputs are disabled.
	central analog outputs	The outputs are disabled. <ul style="list-style-type: none"> ■ Voltage outputs issue 0V ■ Current outputs 0...20mA issue 0mA ■ Current outputs 4...20mA issue 4mA If configured also substitute values may be issued.
	decentral outputs	Same behavior as the central digital/analog outputs.
	decentral inputs	The inputs are cyclically be read by the decentralized station and the recent values are put at disposal.
STOP → RUN res. PowerON	general	First the PII is deleted, then OB 100 is called. After the execution of the OB, the BASP is reset and the cycle starts with: Delete PIO → Read PII → OB 1.

Overall reset

Event	concerns	Effect
	decentral inputs	The inputs are once be read by the decentralized station and the recent values are put at disposal.
RUN	general	The program execution happens cyclically and can therefore be foreseen: Read PII → OB 1 → Write PIO.

PII: Process image inputs, PIO: Process image outputs

4.11 Overall reset

Overview

During the overall reset the entire user memory is erased. Data located in the memory card is not affected.

You have 2 options to initiate an overall reset:

- initiate the overall reset by means of the function selector switch
- initiate the overall reset by means of the configuration software e.g. Siemens SIMATIC manager



You should always issue an overall reset to your CPU before loading an application program into your CPU to ensure that all blocks have been cleared from the CPU.

Overall reset by means of the function selector

Condition

- ➔ The operating mode of the CPU is STOP. Place the function selector on the CPU in position "ST"
- ⇒ the S-LED is on.

Overall reset

1. ➔ Place the function selector in the position MR and hold it in this position for app. 3 seconds.
 - ⇒ The S-LED changes from blinking to permanently on.
2. ➔ Place the function selector in the position ST and switch it to MR and quickly back to ST within a period of less than 3 seconds.
 - ⇒ The S-LED blinks (overall reset procedure).

- 3. The overall reset has been completed when the S-LED is on permanently.

⇒ The S-LED is on.

The following figure illustrates the above procedure:

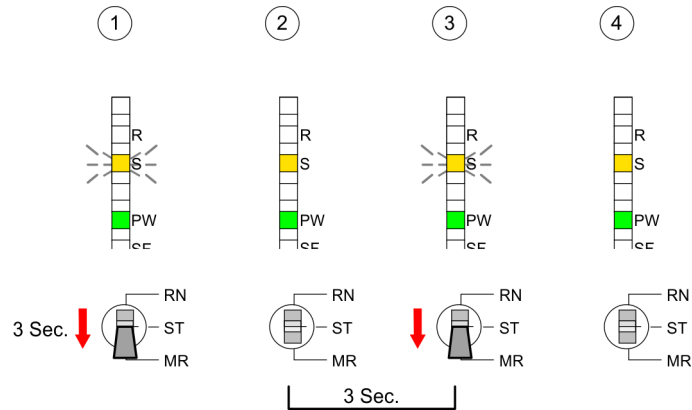

Automatic reload

- 1. If there is a project S7PROG.WLD on the MMC, the CPU attempts to reload this project from MMC.
⇒ The MC LED is on.
- 2. When the reload has been completed the LED is extinguished. The operating mode of the CPU will be STOP or RUN, depending on the position of the function selector.

Overall reset by means of the Siemens SIMATIC manager

Condition

The operating mode of the CPU must be STOP. You may place the CPU in STOP mode by the menu command **PLC > Operating mode**.

Overall reset

- 1. You may request the overall reset by means of the menu command **PLC > Clean/Reset**.
- 2. In the dialog window you may place your CPU in STOP mode and start the overall reset if this has not been done as yet. The S-LED blinks during the overall reset procedure.
⇒ When the S-LED is on permanently the overall reset procedure has been completed.

Automatic reload

- 1. If there is a project S7PROG.WLD on the MMC, the CPU attempts to reload this project from MMC.
⇒ The MC LED is on.
- 2. When the reload has been completed the LED is extinguished. The operating mode of the CPU will be STOP or RUN, depending on the position of the function selector.

Reset to factory setting A *Factory reset* deletes the internal RAM of the CPU completely and sets it back to the delivery state. Please regard that the MPI address is also set back to default 2! More information may be found at the part "Factory reset" further below.

4.12 Firmware update

Overview There is the opportunity to execute a firmware update for the CPU 215-2BT16 and its components via MMC. For this an accordingly prepared MMC must be in the CPU during the startup. So a firmware files can be recognized and assigned with startup, a file name is reserved for each updateable component (see table below). After PowerON and CPU STOP the CPU checks if there is a firmware file on the MMC. If this firmware version is different to the existing firmware version, this is indicated by blinking of the LEDs and the firmware may be installed by an update request.

Latest Firmware at www.vipa.com The latest firmware versions are to be found in the service area at www.vipa.com

Find out CPU firmware version A label on the rear of the module indicates the firmware version. You may display the current firmware version of your CPU via the Siemens SIMATIC manager. To display the firmware version, you go online with the CPU via your PG or PC and start the Siemens SIMATIC manager. Via **PLC > Module status**, register "General", the current firmware version is evaluated and displayed.

Load firmware and transfer it to MMC with reserved file name

- Go to www.vipa.com
- Click on Service > Download > Firmware.
- Navigate to via System 200V > CPU to your CPU and download according to your hardware version the zip file to your PC.
- Open the zip file and copy the files to your MMC.
- Rename this accordingly

Reserved file names By means of a reserved file name in the CPU 215-2BT16 you may transfer a firmware per MMC:

Component	File name order no._release_version.ZIP	New file name at MMC
CPU	Bx000... .bin	firmware.bin
CP	Px000245.pkg	Px000245.pkg



WARNING!

When installing a new firmware you have to be extremely careful. Under certain circumstances you may destroy the CPU, for example if the voltage supply is interrupted during transfer or if the firmware file is defective. In this case, please call the VIPA-Hotline! Please regard that the version of the update firmware has to be different from the existing firmware otherwise no update is executed.

Transfer firmware from MMC into CPU

1. Switch the operating mode switch of your CPU in position ST. Turn off the voltage supply. Plug the MMC with the firmware files into the CPU. Please take care of the correct plug-in direction of the MMC. Turn on the voltage supply.
2. After a short boot-up time, the alternate blinking of the LEDs SF and FC shows that at least a differing firmware file was found on the MMC.
3. You start the transfer of the firmware as soon as you tip the operating mode switch lever downwards to MR within 10s and leave it in ST position.
4. During the update process, the LEDs SF and FC are alternately blinking and MC LED is on. This may last several minutes.
5. The update is successful finished when the LEDs PW, S, SF, FC and MC are on. If they are blinking fast, an error occurred.
6. Turn Power OFF and ON. Now it is checked by the CPU, whether further current firmware versions are available at the MMC. If so, again the LEDs SF and FC flash after a short start-up period. Continue with point 3.

If the LEDs do not flash, the firmware update is ready.

⇒ Now a *factory reset* should be executed (see next page). After that the CPU is ready for duty.

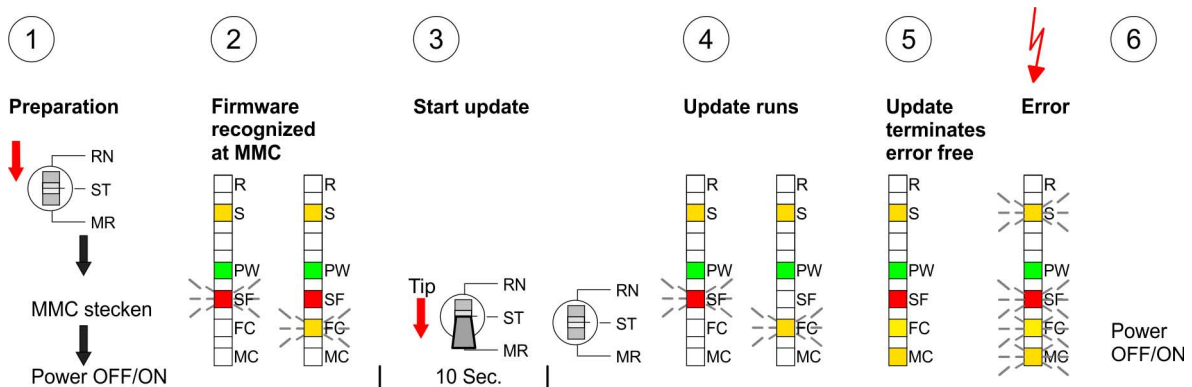

4.13 Factory reset

Proceeding

With the following proceeding the internal RAM of the CPU is completely deleted and the CPU is reset to delivery state. Please note that here also the MPI address is reset to the address 2!

1. ▶ Switch the CPU to STOP.
2. ▶ Push the operating mode switch down to position MR for 30s. Here the S LED flashes. After a few seconds the stop LED changes to static light. Now the S LED changes between static light and flashing. Starting here count the static light states of the S LED.
3. ▶ After the 6. static light release the operating mode switch and tip it downwards to MR. Now the R LED lights up once. This means that the RAM was deleted completely.
4. ▶ For the confirmation of the resetting procedure the LEDs PW and S are on.
5. ▶ Then you have to switch the power supply off and on.

⇒ The proceeding is shown in the following Illustration:

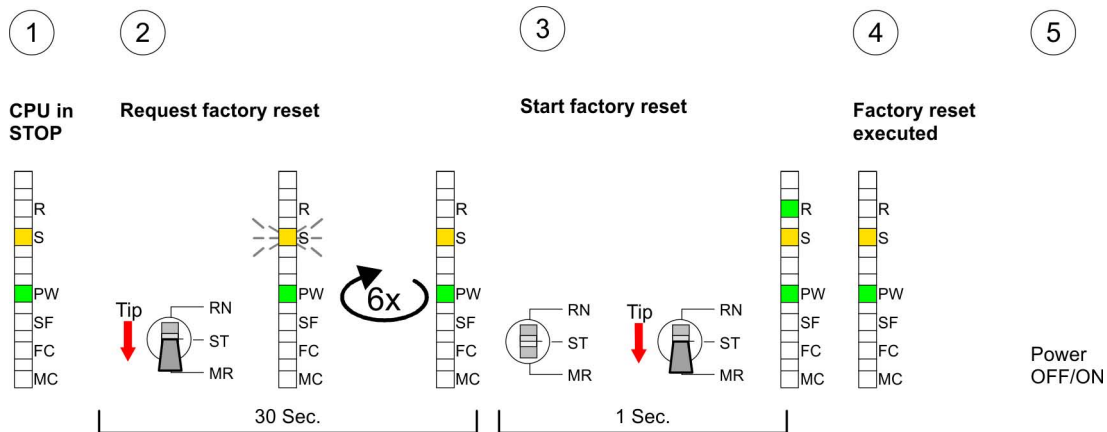

After the firmware update you always should execute a Factory reset.

4.14 Diagnostic entries

Entries in the diagnostic buffer

You may read the diagnostic buffer of the CPU via the Siemens SIMATIC Manager. Besides of the standard entries in the diagnostic buffer, the VIPA CPUs support some additional specific entries in form of event-IDs.

The current content of the diagnostics buffer is stored at the memory card by means of the CMD DIAGBUF.



Every register of the module information is supported by the VIPA CPUs. More information may be found at the online help of the Siemens SIMATIC Manager.

Monitoring the diagnostic entries

To monitor the diagnostic entries you choose the option 'PLC → Module Information' in the Siemens SIMATIC Manager. Via the register "Diagnostic Buffer" you reach the diagnostic window:

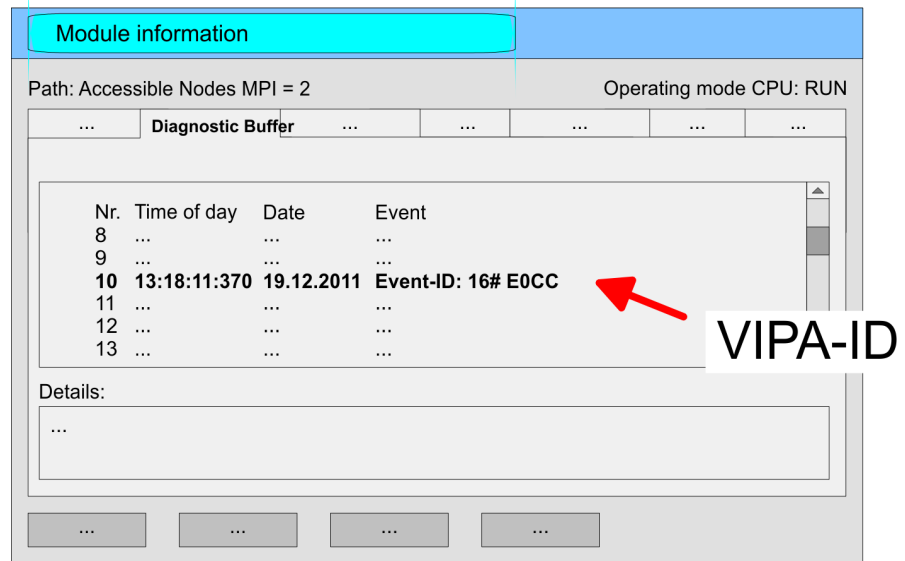

The diagnosis is independent from the operating mode of the CPU. You may store a max. of 100 diagnostic entries in the CPU. The following page shows an overview of the VIPA specific Event-IDs.

Overview of the Event-IDs

Event-ID	Description
0xE003	Error at access to I/O devices Zinfo1: I/O address Zinfo2: Slot
0xE004	Multiple parameterization of a I/O address Zinfo1: I/O address Zinfo2: Slot
0xE005	Internal error -Please contact the VIPA-Hotline!
0xE006	Internal error -Please contact the VIPA-Hotline!
0xE007	Configured in-/output bytes do not fit into I/O area
0xE008	Internal error -Please contact the VIPA-Hotline!
0xE009	Error at access to standard back plane bus
0xE010	Not defined module group at backplane bus recognized Zinfo2: Slot Zinfo3: Type ID
0xE011	Master project engineering at Slave-CPU not possible or wrong slave configuration
0xE012	Error at parameterization
0xE013	Error at shift register access to VBUS digital modules

Using test functions for control and monitoring of variables

Event-ID	Description
0xE014	Error at Check_Sys
0xE015	Error at access to the master Zinfo2: Slot of the master (32=page frame master)
0xE016	Maximum block size at master transfer exceeded Zinfo1: I/O address Zinfo2: Slot
0xE017	Error at access to integrated slave
0xE018	Error at mapping of the master I/O devices
0xE019	Error at standard back plane bus system recognition
0xE01A	Error at recognition of the operating mode (8 / 9 Bit)
0xE0CC	Communication error MPI / Serial
0xE100	MMC access error
0xE101	MMC error file system
0xE102	MMC error FAT
0xE104	MMC error at saving
0xE200	MMC writing finished (Copy Ram to Rom)
0xE210	MMC reading finished (reload after overall reset)
0xE300	Internal Flash writing ready (Copy RAM to ROM)
0xE310	Internal Flash reading finished (reload after battery failure)

4.15 Using test functions for control and monitoring of variables

Overview

For troubleshooting purposes and to display the status of certain variables you can access certain test functions via the menu item **Debug** of the Siemens SIMATIC Manager.

- The status of the operands and the RLO can be displayed by means of the test function '*Debug → Monitor*'.
- The status of the operands and the RLO can be displayed by means of the test function '*PLC → Monitor/Modify Variables*'.

'Debug → Monitor'

This test function displays the current status and the RLO of the different operands while the program is being executed. It is also possible to enter corrections to the program.



When using the test function "Monitor" the PLC must be in RUN mode!

The processing of the states may be interrupted by means of jump commands or by timer and process-related interrupts. The interruption of the processing of statuses does not change the execution of the program. It only shows that the data displayed is no longer valid. At the breakpoint the CPU stops collecting data for the status display and instead of the required data it only provides the PG with data containing the value 0. For this reason, jumps or time and process alarms can result in the value displayed during program execution remaining at 0 for the items below:

- the result of the logical operation RLO
- Status / AKKU 1
- AKKU 2
- Condition byte
- absolute memory address SAZ. In this case SAZ is followed by a "?".

**'PLC
→ Monitor/Modify
Variables'**

This test function returns the condition of a selected operand (inputs, outputs, flags, data word, counters or timers) at the end of program execution. This information is obtained from the process image of the selected operands. During the "processing check" or in operating mode STOP the periphery is read directly from the inputs. Otherwise only the process image of the selected operands is displayed.

- Control of outputs
 - It is possible to check the wiring and proper operation of output modules.
 - You can set outputs to any desired status with or without a control program. The process image is not modified but outputs are no longer inhibited.
- Control of variables
 - The following variables may be modified: I, Q, M, T, C and D.
 - The process image of binary and digital operands is modified independently of the operating mode of the CPU.
 - When the operating mode is RUN the program is executed with the modified process variable. When the program continues they may, however, be modified again without notification.
 - Process variables are controlled asynchronously to the execution sequence of the program.

5 Deployment Ethernet communication

5.1 Basics - Industrial Ethernet in automation

Overview

The flow of information in a company presents a vast spectrum of requirements that must be met by the communication systems. Depending on the area of business the bus system or LAN must support a different number of users, different volumes of data must be transferred and the intervals between transfers may vary, etc. It is for this reason that different bus systems are employed depending on the respective task. These may be subdivided into different classes. The following model depicts the relationship between the different bus systems and the hierarchical structures of a company:

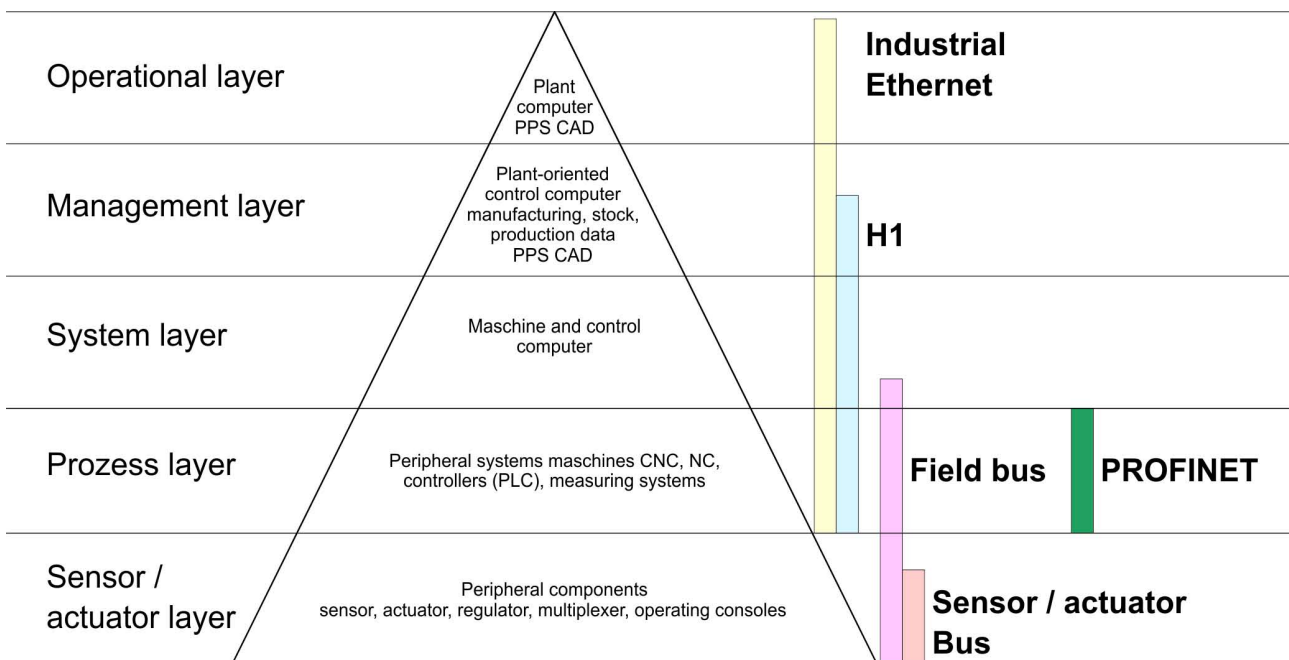

Industrial Ethernet

Industrial Ethernet is an electrical net based on shielded twisted pair cabling or optical net based on optical fibre. Industrial Ethernet is defined by the international standard IEEE 802.3

The net access of Industrial Ethernet corresponds to IEEE 802.3 - CSMA/CD (**C**arrier **S**ense **M**ultiple **A**ccess/**C**ollision **D**etection) scheme:

- Every station "listens" on the bus cable and receives communication messages that are addressed to it.
- Stations will only initiate a transmission when the line is unoccupied.
- In the event that two participants should start transmitting simultaneously, they will detect this and stop transmitting to restart after a random delay time has expired.
- Using switches there is the possibility for communication without collisions.

5.2 Basics - ISO/OSI reference model

Overview

The ISO/OSI reference model is based on a proposal that was developed by the International Standards Organization (ISO). This represents the first step towards an international standard for the different protocols. It is referred to as the ISO-OSI layer model. OSI is the abbreviation for **O**pen **S**ystem **I**nterconnection, the communication between open systems. The ISO/OSI reference model does not represent a network architecture as it does not define the services and protocols used by the different layers. The model simply specifies the tasks that the different layers must perform. All current communication systems are based on the ISO/OSI reference model, which is defined by the ISO 7498 standard. The reference model structures communication systems into 7 layers that cover different communication tasks. In this manner the complexity of the communication between different systems is divided amongst different layers to simplify the task.

The following layers have been defined:

- Layer 7 - Application Layer
- Layer 6 - Presentation Layer
- Layer 5 - Session Layer
- Layer 4 - Transport Layer
- Layer 3 - Network Layer
- Layer 2 - Data Link Layer
- Layer 1- Physical Layer

Depending on the complexity and the requirements of the communication mechanisms a communication system may use a subset of these layers.

Layer 1 - Bit communication layer (physical layer)

The bit communication layer (physical layer) is concerned with the transfer of data bits via the communication channel. This layer is therefore responsible for the mechanical, electrical and the procedural interfaces and the physical communication medium located below the bit communication layer:

- Which voltage represents a logical 0 or a 1?
- The minimum time the voltage is present to be recognized as a bit.
- The pin assignment of the respective interface.

Layer 2 - Security layer (data link layer)

This layer performs error-checking functions for bit strings transferred between two communicating partners. This includes the recognition and correction or flagging of communication errors and flow control functions. The security layer (data link layer) converts raw communication data into a sequence of frames. This is where frame limits are inserted on the transmitting side and where the receiving side detects them. These limits consist of special bit patterns that are inserted at the beginning and at the end of every frame. The security layer often also incorporates flow control and error detection functions. The data security layer is divided into two sub-levels, the LLC and the MAC level. The MAC (**M**edia **A**ccess **C**ontrol) is the lower level and controls how senders are sharing a single transmit channel. The LLC (**L**ogical **L**ink **C**ontrol) is the upper level that establishes the connection for transferring the data frames from one device into the other.

Layer 3 - Network layer	The network layer is an agency layer. Business of this layer is to control the exchange of binary data between stations that are not directly connected. It is responsible for the logical connections of layer 2 communications. Layer 3 supports the identification of the single network addresses and the establishing and disconnecting of logical communication channels. Additionally, layer 3 manages the prior transfer of data and the error processing of data packets. IP (Internet Protocol) is based on Layer 3.
Layer 4 - Transport layer	Layer 4 connects the network structures with the structures of the higher levels by dividing the messages of higher layers into segments and passes them on to the network layer. Hereby, the transport layer converts the transport addresses into network addresses. Common transport protocols are: TCP, SPX, NWLink and NetBEUI.
Layer 5 - Session layer	The session layer is also called the communication control layer. It relieves the communication between service deliverer and the requestor by establishing and holding the connection if the transport system has a short time fail out. At this layer, logical users may communicate via several connections at the same time. If the transport system fails, a new connection is established if needed. Additionally this layer provides methods for control and synchronization tasks.
Layer 6 - Presentation layer	This layer manages the presentation of the messages, when different network systems are using different representations of data. Layer 6 converts the data into a format that is acceptable for both communication partners. Here compression/decompression and encrypting/decrypting tasks are processed. This layer is also called interpreter. A typical use of this layer is the terminal emulation.
Layer 7 - Application layer	The application layer is the link between the user application and the network. The tasks of the application layer include the network services like file, print, message, data base and application services as well as the according rules. This layer is composed from a series of protocols that are permanently expanded following the increasing needs of the user.

5.3 Basics - Terms

Network (LAN)

A network res. LAN (Local Area Network) provides a link between different stations that enables them to communicate with each other. Network stations consist of PCs, IPCs, TCP/IP adapters, etc. Network stations are separated by a minimum distance and connected by means of a network cable. The combination of network stations and the network cable represent a complete segment. All the segments of a network form the Ethernet (physics of a network).

Twisted Pair

In the early days of networking the Triaxial- (yellow cable) or thin Ethernet cable (Cheapernet) was used as communication medium. This has been superseded by the twisted-pair network cable due to its immunity to interference. The CPU has a twisted-pair connector. The twisted-pair cable consists of 8 cores that are twisted together in pairs. Due to these twists this system is provides an increased level of immunity to electrical interference. For linking please use twisted pair cable which at least corresponds to the category 5. Where the

coaxial Ethernet networks are based on a bus topology the twisted-pair network is based on a point-to-point scheme. The network that may be established by means of this cable has a star topology. Every station is connected to the star coupler (hub/switch) by means of a separate cable. The hub/switch provides the interface to the Ethernet.

Hub (repeater)

The hub is the central element that is required to implement a twisted-pair Ethernet network. It is the job of the hub to regenerate and to amplify the signals in both directions. At the same time it must have the facility to detect and process segment wide collisions and to relay this information. The hub is not accessible by means of a separate network address since it is not visible to the stations on the network. A hub has provisions to interface to Ethernet or to another hub res. switch.

Switch

A switch also is a central element for realizing Ethernet on Twisted Pair. Several stations res. hubs are connected via a switch. Afterwards they are able to communicate with each other via the switch without interfering the network. An intelligent hardware analyses the incoming telegrams of every port of the switch and passes them collision free on to the destination stations of the switch. A switch optimizes the bandwidth in every connected segment of a network. Switches enable exclusive connections between the segments of a network changing at request.

5.4 Basics - Protocols

Overview

Protocols define a set of instructions or standards that enable computer to establish communication connections and exchange information as error free as possible. A commonly established protocol for the standardization of the complete computer communication is the so called ISO/OSI layer model, a model based upon seven layers with rules for the usage of hardware and software ↪ *Chapter 5.2 'Basics - ISO/OSI reference model' on page 61*

The following protocols are used:

- Communication connections
 - TCP/IP
 - UDP
 - RFC1006 (ISO-ON-TCP)

TCP/IP

TCP/IP protocols are available on all major systems. At the bottom end this applies to simple PCs, through to the typical mini-computer up to mainframes. For the wide spread of Internet accesses and connections, TCP/IP is often used to assemble heterogeneous system pools. TCP/IP (Transmission Control Protocol / Internet Protocol) collects a various range of protocols and functions. TCP and IP are only two of the protocols required for the assembly of a complete architecture.

■ TCP/IP

- The application layer provides programs like "FTP" and "Telnet" for the PC. The application layer of the Ethernet CP is defined with the user application using the standard handling blocks. These user applications use the transport layer with the protocols TCP or UDP for the data transfer which themselves communicate via the IP protocol with the Internet layer.
- Besides of the IP address ports are used for the addressing. A port address should be within the range of 2000...65535.
- Not depending on the used protocol, the PLC needs the VIPA handling blocks AG_SEND (FC 5) and AG_RECV (FC 6) for data transfer.

■ IP

- IP covers the network layer (Layer 3) of the ISO/OSI layer model.
- The purpose of IP is to send data packages from on PC to another passing several other PCs. These data packages are referred to as datagrams. The IP doesn't neither guarantee the correct sequence of the datagrams nor the delivery at the receiver.
- For the unambiguous identification between sender and receiver 32Bit addresses (IP addresses) are used that are normally written as four octets (exactly 8bit), e.g. 172.16.192.11. These Internet addresses are defined and assigned world-wide, thus every user may communicate with all other TCP/IP users.
- One part of the address specifies the network; the rest serves the identification of the participants inside the network. The boarder between the network and the host part is variable and depends on the size of the network.
- To save IP addresses, so called NAT router are used that have one official IP address and cover the network. Then the network can use any IP address.

■ TCP

- TCP bases directly on the IP and thus covers the transport layer (layer 4) of the ISO/OSI layer model.
- TCP is a connection orientated end-to-end protocol and serves the logic connection between two partners.
- TCP guarantees the correct sequence and reliability of the data transfer. Therefore you need a relatively large protocol overhead that slows down the transfer speed
- Every datagram gets a header of at least 20Byte. This header also contains a sequence number identifying the series. This has the consequence that the single datagrams may reach the destination on different ways through the network.
- Using TCP connections, the telegram length is not transmitted. This means that the recipient has to know how many bytes belong to a message.
- To transfer data with variable length you may begin the user data with the length information and evaluate this at the counter station.

- UDP** UDP (**U**ser **D**atagramm **P**rotocol) is a connection free transport protocol. It has been defined in the RFC768 (**R**equ**e**st for **C**omment). Compared to TCP, it has much fewer characteristics. The addressing happens via port numbers. UDP is a fast unsafe protocol for it doesn't neither care about missing data packages nor about their sequence.
- ISO-on-TCP RFC1006** The TCP transport service works stream orientated. This means that data packages assembled by the user not necessarily have to receive the partner in the same packaging. Depending on the data amount, packages may though come in the correct sequence but differently packed. This causes that the recipient may not recognize the package borders anymore. For example you may send 2x 10Byte packages but the counter station receives them as 20Byte package. But for most of the applications the correct packaging is important. Due to this you need another protocol above TCP. This purpose is defined in the protocol extension RFC1006 (ISO-on-TCP).
- RFC1006 describes the function of an ISO transport interface (ISO 8072) basing upon the transport interface TCP (RFC793).
 - The basic protocol of RFC1006 is nearly identical to TP0 (Transport Protocol, Class 0) in ISO 8073.
 - For RFC1006 is run as protocol for TCP, the decoding takes place in the data section of the TCP package.
 - In contrast to TCP here the receipt of a telegram is confirmed.
 - Instead of ports TSAPs are used for the addressing besides of the IP address. The TSAP length may be 1 ... 16 characters. The entry may happen in ASCII or Hex format.
 - Not depending on the used protocol, the PLC needs the VIPA handling blocks AG_SEND (FC 5) and AG_RECV (FC 6) for data transfer.
 - Contrary to TCP different telegram lengths can be received using RFC1006.

5.5 Basics - IP address and subnet

- IP address structure** Exclusively IPv4 is supported. At IPv4 the IP address is a 32bit address that must be unique within the network and consists of 4 numbers that are separated by a dot. Every IP address is a combination of a *Net-ID* and a *Host-ID* and has the following
- Structure: **xxx.xxx.xxx.xxx**
- Range: 000.000.000.000 to 255.255.255.255
- Net-ID, Host-ID** The **Network-ID** identifies a network res. a network controller that administrates the network. The Host-ID marks the network connections of a participant (host) to this network.
- Subnet mask** The Host-ID can be further divided into a *Subnet-ID* and a new *Host-ID* by using a bit for bit AND assignment with the Subnet mask.
- The area of the original Host-ID that is overwritten by 1 of the Subnet mask becomes the Subnet-ID, the rest is the new Host-ID.

Subnet mask	binary all "1"	binary all "0"	
IPv4 address	Net-ID	Host-ID	
Subnet mask and IPv4 address	Net-ID	Subnet-ID	new Host-ID

Address at first start-up

At the first start-up of the CPU, the Ethernet PG/OP channel and the CP 243 do not have an IP address.

Information about the assignment of IP address data to the Ethernet PG/OP channel may be found in ↗ *'Hardware configuration - Ethernet PG/OP channel'* on page 41.

Information about the assignment of IP address data to the CP 243 may be found in ↗ *'Project engineering CP 243'* on page 71

Address classes

For IPv4 addresses there are five address formats (class A to class E) that are all of a length of 4byte = 32bit.

Class A	0	Network-ID (1+7bit)	Host-ID (24bit)
Class B	10	Network-ID (2+14bit)	Host-ID (16bit)
Class C	110	Network-ID (3+21bit)	Host-ID (8bit)
Class D	1110	Multicast group	
Class E	11110	Reserved	

The classes A, B and C are used for individual addresses, class D for multicast addresses and class E is reserved for special purposes. The address formats of the 3 classes A, B, C are only differing in the length of Network-ID and Host-ID.

Private IP networks

These addresses can be used as net-ID by several organizations without causing conflicts, for these IP addresses are neither assigned in the Internet nor are routed in the Internet. To build up private IP-Networks within the Internet, RFC1597/1918 reserves the following address areas:

Network class	from IP	to IP	Standard subnet mask
A	10.0.0.0	10.255.255.255	255.0.0.0
B	172.16.0.0	172.31.255.255	255.255.0.0
C	192.168.0.0	192.168.255.255	255.255.255.0

(The Host-ID is underlined.)

Reserved Host-IDs

Some Host-IDs are reserved for special purposes.

Host-ID = "0"	Identifier of this network, reserved!
Host-ID = maximum (binary complete "1")	Broadcast address of this network



Never choose an IP address with Host-ID=0 or Host-ID=maximum! (e.g. for class B with subnet mask = 255.255.0.0, the "172.16.0.0" is reserved and the "172.16.255.255" is occupied as local broadcast address for this network.)

5.6 Basics - MAC address and TSAP

MAC address

There is a unique MAC address (**M**edia **A**ccess **C**ontrol) necessary for each CP. Usually a module is labelled with its MAC address by the manufacturer. This address should be used for project engineering of the CP. The MAC address has a length of 6bytes. On delivery the first three bytes specify the manufacturer. These bytes are assigned by the IEEE committee. The last 3 bytes may be assigned by the manufacturer. In a network several stations with the same MAC address may not exist. The MAC address may be changed at any time. You will get a valid MAC address from your network administrator.

- Broadcast address
 - The MAC address, with which all bits are set to 1, is:
FF-FF-FF-FF-FF-FF
This address is used as Broadcast address and addresses all participants in the net.
- Address at first start-up
 - Each CP of a VIPA CPU has an unique MAC address. This may be found on a label beneath the front flap.

TSAP

TSAP means **T**ransport **S**ervice **A**ccess **P**oint. ISO transport connections support TSAP length of 1...16byte. TSAPs may be entered in ASCII format or hexadecimal.

Address parameters

Station A				Station B
remote TSAP	→	ISO transport connection	→	local TSAP
local TSAP	←		←	remote TSAP
MAC address A				MAC address B

An ISO transport connection is specified by a local and a remote connection endpoint. The TSAPs of an ISO transport connection must match as follows:

- Remote TSAP (in CP) = local TSAP (in destination station)
- Local TSAP (in CP) = remote TSAP (in destination station)

5.7 Fast introduction

Overview

At the first start-up respectively at an over all reset with an PowerON again, the CP 243 of the CPU does not have any IP address. The CP may only be reached via the MAC address. IP address parameters may be assigned to the CP by means of the MAC addresses, which may be found on a label at the side of the module. The assignment takes place directly via the hardware configuration of the Siemens SIMATIC manager.

Steps of configuration

For the configuration of the CP 243 for productive connections please follow the following approach:

1. **Commissioning and initialization**
(Assignment of IP address data)
2. **Hardware configuration - CPU**
3. **Configure communication connections**
(Configuration via Siemens NetPro, communication via VIP A handling blocks)
4. **PLC programming** via user application (connection to PLC)
5. **Transfer of the complete project to the CPU**

Information about transferring a project may be found at chapter "Deployment CPU ..." at "Project transfer".



To be compatible to the Siemens SIMATIC manager, the CPU 215-2BT16 from VIP A has to be configured as

CPU 315-2DP (6ES7 315-2AG10-0AB0 V2.6.)

The CP of the CPU 215-2BT16 is always configured virtually as 4. module at the standard bus as CP343-1 (343-1EX11) from Siemens. To be able to address the modules they have to be projected in the hardware configurator from Siemens in form of a virtual PROFIBUS system. The full functionality of the System 200V modules is provided by inclusion of a GSD-file from VIP A.

5.8 Commissioning and initialization

Assembly and commissioning

1. **Install your System 200V with your CPU.**
2. **Wire the system by connecting cables for voltage supply and signals**
3. **Connect your CP 243 with Ethernet.**
4. **Switch on the power supply.**

⇒ After a short boot time, the CP is in idle. At the first commissioning res. after an overall reset of the CPU, the CP 243 and the Ethernet PG/OP channel have no IP address.

Assign IP address parameters

Please regard this function is available with CP firmware version 1.7.4 and up.

You get valid IP address parameters from your system administrator. The assignment of the IP address data happens online in the Siemens SIMATIC Manager starting with version V 5.3 & SP3 with the following proceeding:

1. ▶ Start the Siemens SIMATIC Manager and set via 'Options → Set PG/PC interface' the access path to 'TCP/IP -> Network card ...'.
2. ▶ Open with 'PLC → Edit Ethernet Node n' the dialog window with the same name.
3. ▶ To get the stations and their MAC address, use the [Browse] button or type in the MAC Address. The Mac address may be found at the 2. label beneath the front flap of the CPU.
4. ▶ Choose if necessary the known MAC address of the list of found stations.
5. ▶ Either type in the IP configuration like IP address, subnet mask and gateway. Or your station is automatically provided with IP parameters by means of a DHCP server. Depending of the chosen option the DHCP server is to be supplied with MAC address, equipment name or client ID. The client ID is a numerical order of max. 63 characters. The following characters are allowed: "hyphen", 0-9, a-z, A-Z
6. ▶ Confirm with [Assign IP configuration].



Directly after the assignment the CP 243 is online reachable using the set IP address data.

Since the IP address data, which were assigned here, are deleted at PowerOFF, you have to take them to a project by means of the hardware configuration.

5.9 Hardware configuration - CPU**Overview**

For the project engineering of the CPU 215-2BT16 and the other System 200V modules connected to the same VIPA bus, the hardware configurator from Siemens is to be used. To address the directly plugged peripheral modules, you have to assign a special address in the CPU to every module. The address allocation and the parameterization of the modules takes place in the Siemens SIMATIC manager as a virtual PROFIBUS system. For the PROFIBUS interface is standardized software sided, the functionality is guaranteed by including a GSD-file into the Siemens SIMATIC manager. Transfer your project into the CPU via the MPI interface.

Requirements

The following conditions must be fulfilled for project engineering:

- The Siemens SIMATIC manager is installed at PC respectively PG
- The GSD files have been included in Siemens hardware configurator
- Serial connection to the CPU (e.g. MPI-Adapter)



The configuration of the CPU requires a thorough knowledge of the Siemens SIMATIC manager and the hardware configurator!

Including the GSD-file

1. Go to www.vipa.com > Service > Download > PROFIBUS GSD files and download the file *System_100V_-_200V_Vxxx.zip*.
2. Extract the file to your work directory. The *vipa_21x.gsd* (German) respectively *vipa_21x.gse* (English) can be found at the directory *CPU21x*.
3. Start the Siemens hardware configurator and close every project.
4. Go to **Options** > *Install new GSD file*.
5. Navigate to the directory *CPU21x* and choose the corresponding file **vipa_21x.gsd** (German) or **vipa_21x.gse** (English)
 - ⇒ Now the modules of the VIPA System 200V are integrated in the *hardware catalog* at *PROFIBUS-DP \ Additional field devices \ I/O \ VIPA_System_200V*.

Proceeding

To be compatible with the Siemens SIMATIC manager the following steps should be executed:

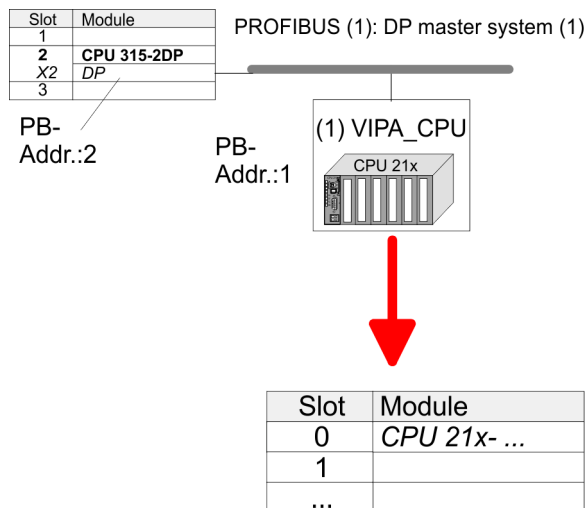

1. Start the hardware configurator from Siemens with a new project.
2. Insert a profile rail from the hardware catalog.
3. Place at slot 2 the following CPU from Siemens CPU 315-2DP (6ES7 315-2AG10-0AB0 V2.6.)
4. For the System 200V create a new PROFIBUS subnet.

5. ▶ Attach the slave system "VIPA_CPU21x" to the subnet with **PROFIBUS-Address 1**
 - ⇒ After installing the vipa_21x.gsd the slave system may be found at the hardware catalog at PROFIBUS DP > Additional field devices > IO > VIPA_System_200V.
6. ▶ Place always at the **1. slot** the corresponding 215-2BT16, by taking it from the hardware catalog.

5.10 Project engineering CP 243

Since the behavior of the CP part of the CPU is the same as the CP343-1 from Siemens, you have to place a virtual CP343-1 (Simatic300 \ CP-300 \ Industrial Ethernet \ CP 343-1 \ 6GK7 343-1EX11 0XE0) at slot 4 beneath the CPU 315-2DP (6ES7 315-2AG10-0AB0 V2.6.).

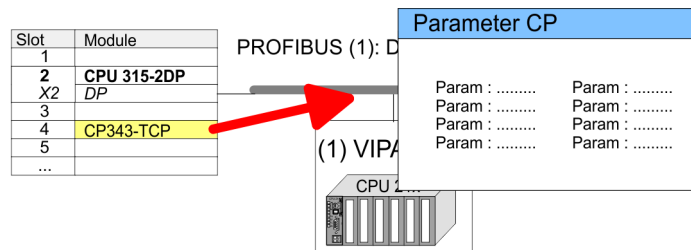

Parameterization of the IP address data

1. ▶ Open the property window of the CP via double-click on the CP.
2. ▶ At "General" enter a device name. The device name on the Ethernet subnet must be unique.
3. ▶ On [Properties] for the CP enter the IP address, subnet mask and gateway and select the wanted subnet.

5.11 Configure connections

5.11.1 Overview

The project engineering of connections i.e. the "link-up" between stations happens in NetPro from Siemens. NetPro is a graphical user interface for the link-up of stations. A communication connection enables the program controlled communication between two participants at the Industrial Ethernet. The communication partners may here be part of the same project or - at multi projects - separated within related part projects. Communication connections to partners outside of a project are configured via the object "In unknown project" or via deputy objects like "Other stations" or Siemens "SIMATIC S5 Station". The communication is controlled by the user program with VIPA handling blocks. To use this blocks, configured communication connections are always necessary in the active station.

Properties communication connection

The following properties are characterizing a communication connection:

- One station always executes an active connection establishment.
- Bi-directional data transfer (Send and receive on one connection)

- Both participant have equal rights, i.e. every participant may initialize the send res. receive process event controlled.
- Except of the UDP connection, at a communication connection the address of the communication partner is set via the project engineering. Here the connection is active established by one station.

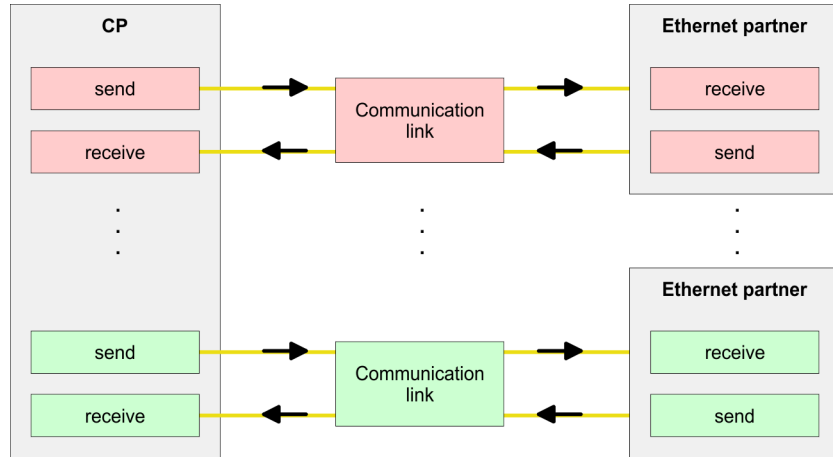

Requirements

- Siemens SIMATIC Manager V 5.3 SP3 or higher and SIMATIC NET are installed.
- With the hardware configuration the CP was assigned with IP address data by the properties.



Every station outside of the recent project must be configured as replacement objects like e.g. Siemens "SIMATIC S5" or "other station" or with the object "In unknown project". When creating a connection you may also choose the partner type "unspecified" and set the required remote parameter directly in the connection dialog.

5.11.2 Siemens NetPro

Work environment of NetPro

For the project engineering of connections, a thorough knowledge with NetPro from Siemens is required! The following passage only describes the basic usage of NetPro. More detailed information about NetPro is to be found in the according online manual res. documentation. Start NetPro by clicking on a "net" in the Siemens SIMATIC Manager or on "connections" within the CPU.

The environment of NetPro has the following structure:

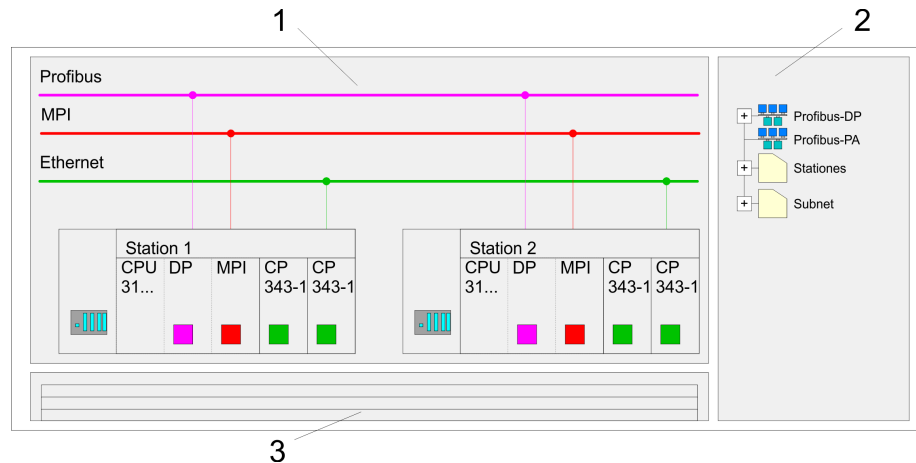

- 1 **Graphic net view:** All stations and networks are displayed in a graphic view. By clicking on the according component you may access and alter the concerning properties.
- 2 **Net objects:** This area displays all available net objects in a directory view. By dragging a wanted object to the net view you may include further net objects and open them in the hardware configurator.
- 3 **Connection table:** The connection table lists all connections in a table. This list is only shown when you highlighted a connectable module like e.g. a CPU. You may insert new connections into this table with the according command.

PLC stations

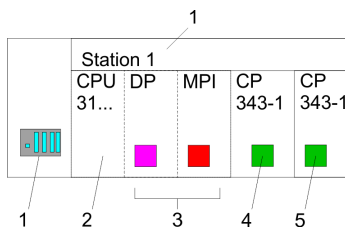

You receive the following graphical display for every PLC station and their component. By selecting the single components, the context menu offers you several functions:

- 1 **Station:** This includes a PLC station with rack, CPU and communication components. Via the context menu you may configure a station added from the net objects and its concerning components in the hardware configurator. After returning to NetPro, the new configured components are shown.
- 2 **CPU:** A click onto the CPU shows the connection table. The connection table shows all connections that are configured for the CPU.
- 3 **Internal communication components:** This shows the communication components that are available in your CPU. For the NET-CPU is configured as Siemens CPU, the internal components do not show the CP. Due to this, the internal CPs of the NET-CPU must be configured as external CPs behind the really plugged modules. The CPs are then also shown in NetPro as external CPs (4, 5) in the station.
- 4 **Ethernet PG/OP channel:** The internal Ethernet PG/OP channel must always be configured as external CP in the hardware configuration. This CP only serves the PG/OP communication. Configurable connections are not possible.
- 5 The internal CP 243 must always be configured as external 2. CP in the hardware configuration after the Ethernet PG/OP channel.

Link up stations

NetPro offers you the option to link-up the communicating stations. You may link-up the stations via the properties in the hardware configuration or graphically via NetPro. For this you point the mouse on the coloured net mark of the according CP and drag and drop it to the net you want to link. Now the CP is linked up to the wanted net by means of a line.

Configure connections > Siemens NetPro

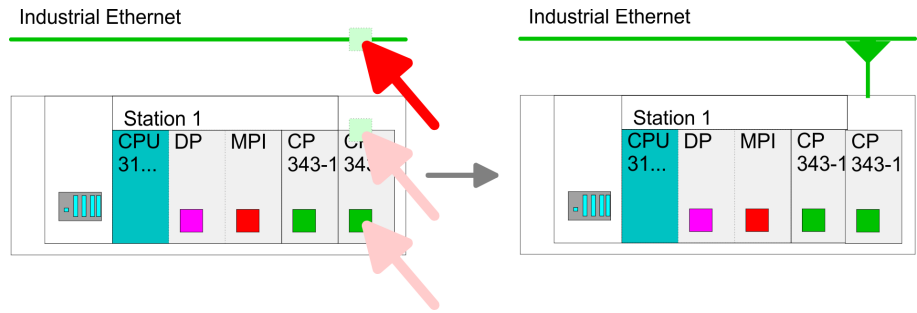

Projecting connections

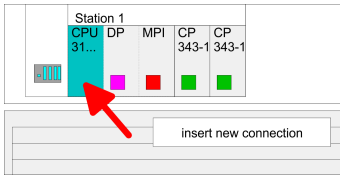

1. ➤ For the project engineering of connections, open the connection list by selecting the according CPU. Open 'Context menu' ➔ *Insert new connection*:
 - Connection partner (partner station)
 - A dialog window opens where you may choose the *connection partner* and the *Connection type*.
 - Specified connection partner
 - Each station configured in the Siemens SIMATIC manager is listed in the table of connection partner.
 - These stations are unique *specified* by an IP address and a subnet mask.
 - Unspecified connection partner
 - Here the connection partner may exist in the current project or in an unknown project.
 - Connection jobs to an unknown project must be defined by an unique connection name, which is to be used in the projects of both stations.
 - Due to this allocation the connection remains *unspecified*.
 - All broadcast stations
 - Exclusive at UDP connections you may send to every reachable participant.
 - The receipt of user data is not possible.
 - The broadcast participants are specified by one port and one broadcast address at sender and receiver.
 - Per default, broadcasts that are only serving the Ethernet communication, like e.g. ARP-Requests (Search MAC <> IP address), are received and accordingly processed.
 - For the identification of the broadcast participants within the net, you have to define a valid broadcast address as partner IP during project engineering of a broadcast connection.
 - Additionally to the broadcast address you have to set a common port for sender and receiver.
 - All multicast stations
 - By selecting '*All Multicast stations*' you define that UDP telegrams have to be sent respectively received by all participants of a multicast group.
 - In contrast to broadcast here a reception is possible.
 - For the identification of the multicast participants within the net, you have to define one valid multicast group address and one port for sender and receiver. The maximum number of multicast circles, which are supported by the CP, is identical to the maximum number of connections.
 - Connection types

The following connection types are available for communication:

 - *Siemens S7 connections, Send/Receive connections* (TCP, ISO-on-TCP and ISO transport) for secured data transfer of data blocks between two Ethernet stations.
 - *UDP* for not secured data transfer of data blocks between two Ethernet stations.

2. ▶ Select the connection partner and the type of connection and confirm with [OK].
 - ⇒ If activated, a properties dialog for the according connection opens as link to your PLC user program.

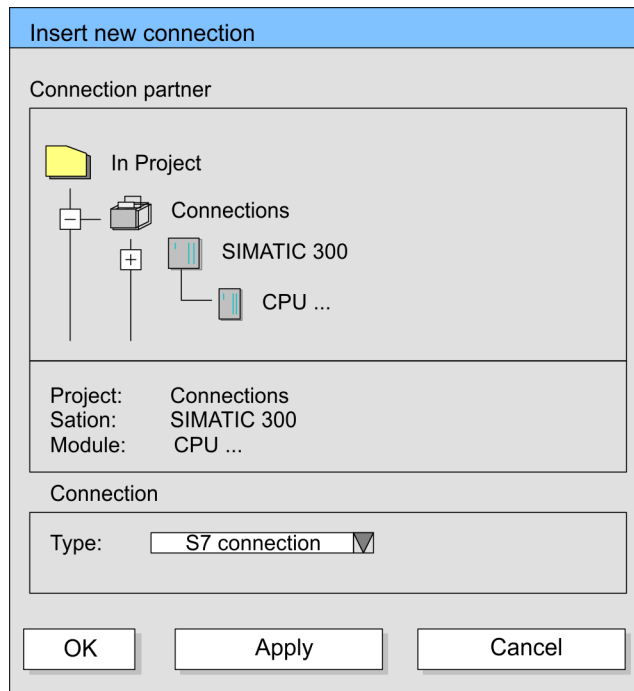

3. ▶ After every connection was configured by this way, you may "save and compile" your project and exit NetPro.

5.11.3 Connection type - Send/Receive

Send/Receive connections

At the PLC side for data transfer with these connections the VIPA handling blocks AG_SEND (FC 5) and AG_RECV (FC 6) are to be used.

Send/receive connections are the following connections:

- TCP (SEND-RECEIVE, FETCH-WRITE PASSIVE)
- ISO-on-TCP (SEND-RECEIVE, FETCH-WRITE PASSIVE)
- ISO-on-TCP (SEND-RECEIVE, FETCH-WRITE PASSIVE)
- UDP (SEND-RECEIVE)

The following parameters define a connection end point:

Station A				Station B
remote port:	→	TCP connection	→	local port
local port	←		←	remote port
IP address A				IP address B

Station A				Station B	
remote TSAP	→	ISO TCP connection	→	local TSAP	
local TSAP	←		←	remote TSAP	
IP address A				IP address B	

Station A				Station B	
remote TSAP	→	ISO transport connection	→	local TSAP	
local TSAP	←		←	remote TSAP	
MAC address A				MAC address B	

Station A				Station B	
remote port	→	UDP connection	→	local port	
local port	←		←	remote port	
IP address A				IP address B	

Combination options with the different operating modes

Connection partner	Connection type	Connection establishment	Connection	Operating mode
specified in NetPro (in current project)	TCP / ISO-on-TCP / ISO-Transport	active/passive	specified	SEND/RECEIVE
	UDP	-		
unspecified in NetPro (in current project)	TCP / ISO-on-TCP / ISO-Transport	active	specified	SEND/RECEIVE
		passive	part specified (Port/TSAP)	SEND/RECEIVE FETCH PASSIVE WRITE PASSIVE
	UDP	-	unspecified	specified
unspecified in NetPro (in unknown project)	TCP / ISO-on-TCP / ISO-Transport	active	specified (connection name in an other project)	SEND/RECEIVE
		passive		SEND/RECEIVE FETCH PASSIVE WRITE PASSIVE
	UDP	-		SEND/RECEIVE
All broadcast stations	UDP	-	specified (Port, Broadcast addr.)	SEND
All multicast stations	UDP	-	specified (Port, Multicast group)	SEND/RECEIVE

In the following each relevant parameters of the different connection types are described:

■ **General**

In this tab the general connection parameters are listed, which identify the local connection end point.

– **ID**

This entry is identical to the entry of the connection table. The value may always be changed. Please also regard to adjust the ID parameter of the call interface of the FC.

– **Name**

This field contains the name of the connection. The name is generated by the system and may be changed on every time.

– **Via CP [Route]**

Here is the CP listed, which should be used for connection. With the button [Route] the appropriate CP may be selected for communication. Do not select the 1. CP of the route for communication connections. The 1. CP is always the Ethernet PG/OP channel, which does not support configurable connections.

– **Active connection establishment**

If activated the connection to the partner is active established by the local station. Here the partner is to be specified in the tab 'Addresses'. At an unspecified connection the connection is passive established.

■ **Block parameters**

- Here the parameters *ID* and *LADDR* for your user program are shown. Both are parameters, which are to be preset if you use the FC 5 and FC 6 (AG_SEND, AG_RECEIVE). Please always use the VIPA FCs, which you may receive from VIPA.

■ **Addresses**

The Addresses tab displays the relevant local and remote address information as proposed values. Depending on the kind of communication the address information may remain unspecified.

– **Port**

Ports respectively port addresses are defining the access point to the user application within the station/CPU. These must be unique. A port address should be within the range of 2000...65535.

– **TSAP**

ISO-on-TCP and ISO transport support TSAP lengths (Transport **S**ervice **A**ccess **P**oint) of 1...16byte. You may enter the TSAP in ASCII or hexadecimal format. The calculation of the length happens automatically.

■ Options

Depending on the specification of the connecting partner the following *operating modes* may be set respectively displayed:

– SEND/RECEIVE

The SEND/RECEIVE interface allows the program-controlled communication to any partner station via a configured connection. Here the data transfer happens by a call from your user application. The FC5 and FC6 that are part of the VIPA block library are serving as interface. This enables your PLC to send messages depending on process events.

– FETCH/WRITE PASSIVE

With the help of FETCH/WRITE services partner systems have the direct access to memory areas of the CPU. These are "passive" communication connections that have to be configured. The connections are "actively" established by the connection partner.

– FETCH PASSIVE (request data)

FETCH allows a partner system to request data.

– WRITE PASSIVE (write data)

This allows a partner system to write data in the data area of the CPU.

■ Overview

Here every configured connections of this station and its partner are displayed. These data are information and may not be changed.



- *If a CP is exchanged by another one, this must at least provide the same services and must at least have the same version level. Only this can guarantee the connections configured via the CP to remain consistent and useable.*
- *By appropriate shift respectively delete activities in the Siemens SIMATIC manager connections may lose the allocation to the CP. These connections are marked with "!" at ID of the overview.*

5.11.3.1 FC 5 - AG_SEND / FC 6 - AG_RECV - CP 343 communication

Overview

The two blocks serve the processing of the Ethernet-CP 343 connection commands on the side of the PLC. Including these blocks in the cycle block OB1 you may send and receive data cyclically.

Within these blocks, the SFCs 205 and 206 are called that are stored as special function blocks in the CPU.



Please regard that you may only use the SEND/RECV-FCs from VIPA in your user application for the communication with VIPA-CPs. At a change to VIPA-CPs in an already existing project, the present AG_SEND / AG_LSEND res. AG_RECV / AG_LRECV may be replaced by AG_SEND res. AG_RECV from VIPA without adjustment. Due to the fact that the CP automatically adjusts itself to the length of the data to transfer, the L variant of SEND res. RECV is not required for VIPA CPs.

Communication blocks	<p>For the communication between CPU and Ethernet-CP 343, the following FCs are available:</p> <p>AG_SEND (FC 5)</p> <p>This block transfers the user data from the data area given in <i>SEND</i> to the CP specified via <i>ID</i> and <i>LADDR</i>. As data area you may set a PA, bit memory or data block area. When the data area has been transferred without errors, "order ready without error" is returned.</p> <p>AG_RECV (FC 6)</p> <p>The block transfers the user data from the CP into a data area defined via <i>RECV</i>. As data area you may set a PA, bit memory or data block area. When the data area has been transferred without errors, "order ready without error" is returned.</p>
Status displays	<p>The CP processes send and receive commands independently from the CPU cycle and needs for this transfer time. The interface with the FC blocks to the user application is here synchronized by means of acknowledgements/receipts.</p> <p>For status evaluation the communication blocks return parameters that may be evaluated directly in the user application.</p> <p>These status displays are updated at every block call.</p>
Deployment at high communication load	<p>Do not use cyclic calls of the communication blocks in OB 1. This causes a permanent communication between CPU and CP. Program instead the communication blocks within a time OB where the cycle time is higher res. event controlled.</p>
FC call is faster than CP transfer time	<p>If a block is called a second time in the user application before the data of the last time is already completely send res. received, the FC block interface reacts like this:</p> <p>AG_SEND</p> <p>No command is accepted until the data transfer has been acknowledged from the partner via the connection. Until this you receive the message "Order running" before the CP is able to receive a new command for this connection.</p> <p>AG_RECV</p> <p>The order is acknowledged with the message "No data available yet" as long as the CP has not received the receive data completely.</p>
AG_SEND, AG_RECV in the user application	<p>The following illustration shows a possible sequence for the FC blocks together with the organizations and program blocks in the CPU cycle:</p>

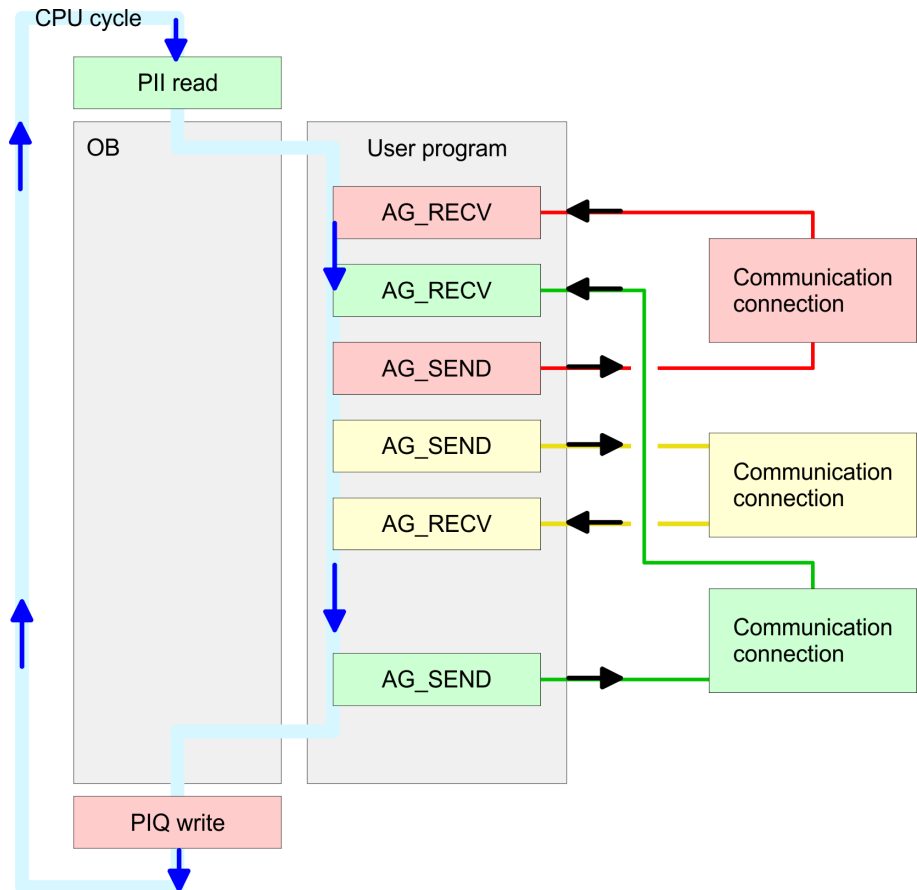

The FC blocks with concerning communication connection are summed up by colour. Here you may also see that your user application may consist of any number of blocks. This allows you to send or receive data (with AG_SEND res. AG_RECV) event or program driven at any wanted point within the CPU cycle. You may also call the blocks for **one** communication connection several times within one cycle.

AG_SEND (FC 5)

By means of AG_SEND the data to send are transferred from the CPU to an Ethernet CP 343.

Parameters

Parameter	Declaration	Data type	Description
ACT	INPUT	BOOL	Activation of the sender 0: Updates <i>DONE</i> , <i>ERROR</i> and <i>STATUS</i> 1: The data area defined in <i>SEND</i> with the length <i>LEN</i> is send
ID	INPUT	INT	Connection number 1 ... 16 (identical with <i>ID</i> of NetPro)
LADDR	INPUT	WORD	Logical basic address of the CP (identical with <i>LADDR</i> of NetPro)
SEND	INPUT	ANY	Data area
LEN	INPUT	INT	Number of bytes from data area to transfer

Parameter	Declaration	Data type	Description
DONE	OUTPUT	BOOL	Status parameter for the order 0: Order running 1: Order ready without error
ERROR	OUTPUT	BOOL	Error message 0: Order running (at <i>DONE</i> = 0) 0: Order ready without error (at <i>DONE</i> = 1) 1: Order ready with error
STATUS	OUTPUT	WORD	Status message returned with <i>DONE</i> and <i>ERROR</i> . More details are to be found in the following table.

AG_RECV (FC 6)

With the 1. call of AG_RECV a receive buffer for the communication between CPU and an Ethernet CP 343 is established. From now on received data are automatically stored in this buffer. As soon as after calling AG_RECV the return value of *NDR* = 1 is returned, valid data are present.

Since with a further call of AG_RECV the receive buffer is established again for the receipt of new data, you have to save the previous received data.

Parameters

Parameter	Declaration	Data type	Description
ID	INPUT	INT	Connection number 1 ... 16 (identical with <i>ID</i> of NetPro)
LADDR	INPUT	WORD	Logical basic address of the CP (identical with <i>LADDR</i> of NetPro)
RECV	INPUT	ANY	Data area for the received data.
NDR	OUTPUT	BOOL	Status parameter for the order 0: Order running 1: Order ready data received without error
ERROR	OUTPUT	BOOL	Error message 0: Order running (at <i>NDR</i> = 0) 0: Order ready without error (at <i>NDR</i> = 1) 1: Order ready with error
STATUS	OUTPUT	WORD	Status message returned with <i>NDR</i> and <i>ERROR</i> . More details are to be found in the following table.
LEN	OUTPUT	INT	Number of bytes that have been received

DONE, ERROR, STATUS

The following table shows all messages that can be returned by the Ethernet CP 343 after a SEND res. RECV command.

A "-" means that this message is not available for the concerning SEND res. RECV command.

DONE (SEND)	NDR (RECV)	ERROR	STATUS	Description
1	-	0	0000h	Order ready without error.
-	1	0	0000h	New data received without error.
0	-	0	0000h	No order present.
-	0	0	8180h	No data available yet.
0	0	0	8181h	Order running
0	0	1	8183h	No CP project engineering for this order.
0	-	1	8184h	System error
-	0	1	8184h	System error (destination data area failure).
0	-	1	8185h	Parameter <i>LEN</i> exceeds source area <i>SEND</i> .
	0	1	8185h	Destination buffer (RECV) too small.
0	0	1	8186h	Parameter <i>ID</i> invalid (not within 1 ...16).
0	-	1	8302h	No receive resources at destination station, receive station is not able to process received data fast enough res. has no receive resources reserved.
0	-	1	8304h	The connection is not established. The send command shouldn't be sent again before a delay time of > 100ms.
-	0	1	8304h	The connection is not established. The receive command shouldn't be sent again after a delay time of > 100ms.
0	-	1	8311h	Destination station not available under the defined Ethernet address.
0	-	1	8312h	Ethernet error in the CP.
0		1	8F22h	Source area invalid, e.g. when area in DB not present Parameter <i>LEN</i> < 0
-	0	1	8F23h	Source area invalid, e.g. when area in DB not present Parameter <i>LEN</i> < 0
0	-	1	8F24h	Range error at reading a parameter.
-	0	1	8F25h	Range error at writing a parameter.
0	-	1	8F28h	Orientation error at reading a parameter.
-	0	1	8F29h	Orientation error at writing a parameter.
-	0	1	8F30h	Parameter is within write protected 1. recent data block
-	0	1	8F31h	Parameter is within write protected 2. recent data block
0	0	1	8F32h	Parameter contains oversized DB number.

DONE (SEND)	NDR (RECV)	ERROR	STATUS	Description
0	0	1	8F33h	DB number error
0	0	1	8F3Ah	Area not loaded (DB)
0	-	1	8F42h	Acknowledgment delay at reading a parameter from peripheral area.
-	0	1	8F43h	Acknowledgment delay at writing a parameter from peripheral area.
0	-	1	8F44h	Address of the parameter to read locked in access track
-	0	1	8F45h	Address of the parameter to write locked in access track
0	0	1	8F7Fh	Internal error e.g. invalid ANY reference e.g. parameter <i>LEN</i> = 0.
0	0	1	8090h	Module with this module start address not present or CPU in STOP.
0	0	1	8091h	Module start address not within double word grid.
0	0	1	8092h	reference contains type setting unequal BYTE.
-	0	1	80A0h	Negative acknowledgment at reading the module.
0	0	1	80A4h	reserved
0	0	1	80B0h	Module doesn't recognize record set.
0	0	1	80B1h	The length setting (in parameter <i>LEN</i>) is invalid.
0	0	1	80B2h	reserved
0	0	1	80C0h	Record set not readable.
0	0	1	80C1h	The set record set is still in process.
0	0	1	80C2h	Order accumulation.
0	0	1	80C3h	The operating sources (memory) of the CPU are temporarily occupied.
0	0	1	80C4h	Communication error (occurs temporarily; a repetition in the user application is reasonable).
0	0	1	80D2h	Module start address is wrong.

Status parameter at reboot

At a reboot of the CP, the output parameters are set as follows:

- DONE = 0
- NDR = 0
- ERROR = 0
- STATUS = 8180h (at AG_RECV)
- STATUS = 8181h (at AG_SEND)

5.12 NCM diagnostic - Help for error diagnostic

NCM diagnostics - Help for error diagnostics

This page shall help you with the error diagnostics. The following check list shows a number of typical problems and their probable causes:

Question	Remedy with "no"
CPU in RUN?	<ul style="list-style-type: none"> ■ Check DC 24V power supply. ■ Set the operating mode switch to position RUN. ■ Check PLC program and transfer it again.
AG_SEND, AG_RECV in user application?	These 2 blocks are required in the user application for the data transfer between CP and CPU. Both blocks must also be called with a passive connection.
Is CP able to connect?	<ul style="list-style-type: none"> ■ Check Ethernet cable (at a point-to-point connection a crossed Ethernet cable is to be used). ■ Check IP address.
Can data be transferred?	<ul style="list-style-type: none"> ■ Check Port no. for read and write. ■ Check source and destination areas. ■ Check if the 2. CP is selected in the route. ■ Enlarge the receive respectively send buffer defined via the ANY pointer.
Is the complete data block sent at ISO-on-TCP?	<ul style="list-style-type: none"> ■ Check the LEN parameter at AG_SEND. ■ Set the receive respectively send buffer defined via the ANY pointer to the required size.

Siemens NCM S7 diagnostic

The CP supports the Siemens NCM diagnostic tool. The NCM diagnostic tool is part of the Siemens SIMATIC manager. This tool delivers information about the operating state of the communication functions of the online CPs dynamically.

The following diagnostic functions are available:

- Check operating state at Ethernet
- Read the diagnostic buffer of the CP
- Diagnostics of connections

Start NCM diagnostic

The diagnostic tool is started by *'Windows-START menu → SIMATIC → ... NCM S7 → Diagnostic'*.

Structure

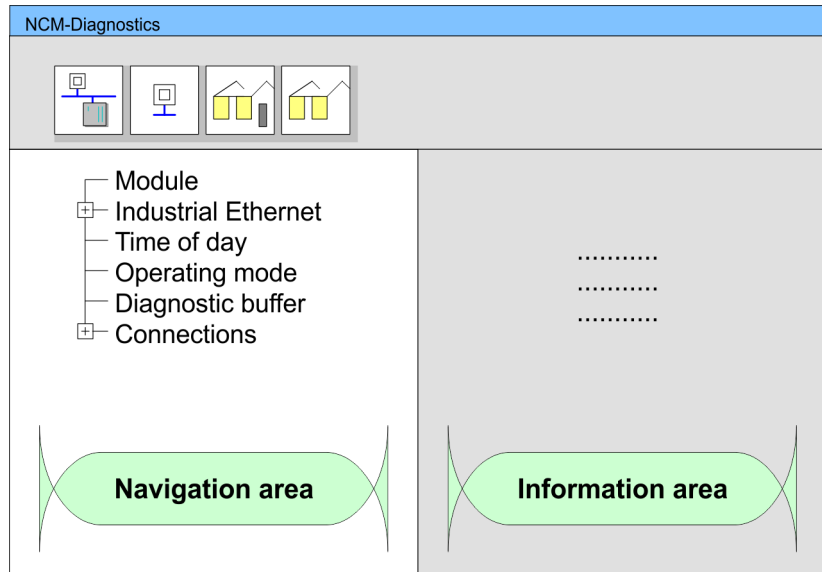

The working surface of the diagnostic tool has the following structure:

- The 'navigation area' at the left side contains the hierarchical listed diagnostic objects. Depending on CP type and configured connections there is an adjusted object structure in the navigation area.
- The 'information area' at the right side always shows the result of the navigation function you chose in the navigation area.

No diagnostic without connection

A diagnostic always requires an online connection to the CP you want to control. For this click at  the symbol bar.

The following dialog window appears:

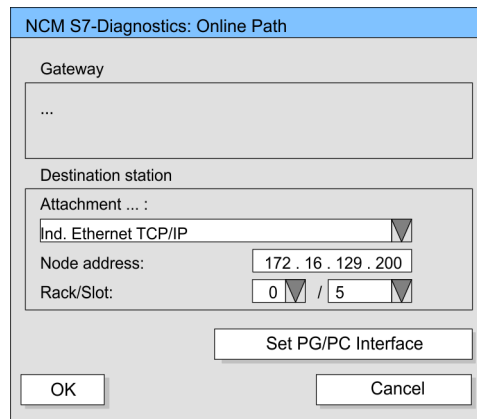

Set the following parameters at 'Destination station':

- **Attachment ...:**
Ind. Ethernet TCP/IP
- **Node addr.:**
Enter the IP address of the CP
- **Rack/slot:**
Enter the module rack and slot of the CP 343 that you've placed at the 2. slot. Set your PG/PC interface to "TCP/IP -> Network card ". Via [OK] you start the online diagnostic.

Read diagnostic buffer The CP has a diagnostic buffer. This has the architecture of a ring memory and may store up to 100 diagnostic messages. The NCM diagnostic allows you to monitor and evaluate the diagnostic messages via the diagnostic object *Diagnostic buffer*. Via a double click on a diagnostic message the NCM diagnostic shows further information.

Approach for diagnostic You execute a diagnostic by clicking on a diagnostic object in the navigation area. More functions are available via the menu and the symbol bar.



Please always control the preconditions for an operative communication using the check list. ↗ 'NCM diagnostics - Help for error diagnostics' on page 85

For the aimed diagnostic deployment the following approach is convenient:

1. ▶ Start diagnostic.
2. ▶ Open the dialog for the online connection with , enter connection parameters and establish the online connection with [OK].
3. ▶ Identify the CP and check the recent state of the CP via module status.
4. ▶ Check the connections for particularities like:
 - Connection status
 - Receive status
 - Send status
5. ▶ Control and evaluate the diagnostic buffer of the CP via *'Diagnostic buffer'*.
6. ▶ As needed, alter project engineering respectively programming and restart diagnostic.

5.13 Coupling to other systems

Overview

The operating mode FETCH/WRITE supported at TCP res. ISO-on-TCP can be used for accesses of partner devices to the PLC system memory. To be able to use this access also for example for implementation in PC applications you have to know the telegram structure for orders. The specific headers for request and acknowledgement telegrams have per default a length of 16Byte and are described at the following pages.

ORG format

The organization format is the abbreviated description of a data source or a data destination in a PLC environment. The available ORG formats are listed in the following table. The ERW-identifier is used for the addressing of data blocks. In this case the data block number is entered into this identifier. The start address and quantity provide the address for the memory area and they are stored in HIGH-/LOW- format (Motorola-formatted addresses)

Description	Type	Range
ORG identifier	BYTE	1...x
ERW identifier	BYTE	1...255
Start address	HILOWORD	0...y
Length	HILOWORD	1...z

The following table contains a list of available ORG-formats. The "length" must not be entered as -1 (FFFFh).

ORG identifier 01h-04h

CPU area	DB	MB	EB	AB
ORG identifier	01h	02h	03h	04h
Description	Source/destination data from/into data Block in main memory.	Source/destination data from/into flag memory area	Source/destination data from/into process image of the inputs (PII).	Source/destination data from/into process image of the outputs (PIQ).
ERW identifier (DBNO)	DB, from where the source data is retrieved or to where the destination data is transferred.	irrelevant	irrelevant	irrelevant
Start address significance	DBB-No., from where the data is retrieved or where the data is saved.	MB-No., from where the data is retrieved or where the data is saved.	IB-No., from where the data is retrieved or where the data is saved.	QB-No., from where the data is retrieved or where the data is saved.
Length significance	Length of the source/destination data block in <u>words</u> .	Length of the source/destination data block in bytes	Length of the source/destination data block in bytes	Length of the source/destination data block in bytes

ORG identifier 05h-07h

CPU area	PB	ZB	TB
ORG identifier	05h	06h	07h
Description	source/destination data from/into peripheral modules. Input module for source data, output module for destination data.	source/destination data from/into counter cells.	Source/destination data from/into timer cells.
ERW identifier (DBNO)	irrelevant	irrelevant	irrelevant
Start address Significance	PB-No., from where the data can be retrieved or where it is saved.	ZB-No., from where the data can be retrieved or where it is saved.	TB-No., from where the data can be retrieved or where it is saved.
Length Significance	Length of the source/destination data block in bytes.	Length of the source/destination data block in words (counter cell = 1 word).	Length of the source/destination data block in words (counter cell = 1 word).

Transfer of blocks with numbers >255

ORG identifier 81h-FFh

To transfer data blocks of the number range 256 ... 32768 you may use the ORG identifier 81h-FFh. For the setting of a DB No. >255 needs a length of one word, the DBNO_{new} is assembled from the content of the ORG identifier and the DBNO. DBNO_{new} is created as word as follows:

DBNO_{new}

High-Byte							Low-Byte								
1	x	x	x	x	x	x	x	x	x	x	x	x	x	x	x
ORG identifier (0XXXXXXXX)							DBNR (XXXXXXXX)								

If the highest bit of the ORG identifier is set, the Low-Byte of DBNO_{new} is defined via DBNO and the High-Byte of DBNO_{new} via ORG identifier, where the highest bit of the ORG identifier is eliminated. The following formula illustrates this:

$$DBNO_{new} = 256 \times (ORG\text{-identifier AND } 7Fh) + DBNO$$

Structure of PLC-Header

For every FETCH and WRITE the CP generates PLC header for request and acknowledgment messages. Normally the length of these headers is 16Bytes and have the following structure:

WRITE

Request telegram Remote Station	Acknowledgement telegram CP
System ID = "S5" (Word)	System ID ="S5" (Word)
Length Header = 10h (Byte)	Length Header =10h (Byte)
ID OP-Code = 01h (Byte)	ID OP-Code =01h (Byte)
Length OP-Code = 03h (Byte)	Length OP-Code =03h (Byte)
OP-Code = 03h (Byte)	OP-Code =04h (Byte)
ORG block = 03h (Byte)	Ackn. block = 0Fh (Byte)
Length ORG block = 08h (Byte)	Length Ack. block = 03h (Byte)
ORG identifier* (Byte)	Error no. (Byte)
ERW identifier (Byte)	Empty block = FFh (Byte)
Start address (Word)	Length empty block = 07h (Byte)
Length (Word)	5 empty bytes attached
Empty block = FFh (Byte)	

Example communication CPU 215-2BT16

Request telegram Remote Station	Acknowledgement telegram CP
Length empty block = 02h (Byte)	
Data up to 64kByte (only if error no.=0)	

FETCH

Request telegram Remote Station	Acknowledgement telegram CP
System ID = "S5" (Word)	System ID ="S5" (Word)
Length Header = 10h (Byte)	Length Header =10h (Byte)
ID OP-Code = 01h (Byte)	ID OP-Code =01h (Byte)
Length OP-Code = 03h (Byte)	Length OP-Code =03h (Byte)
OP-Code = 05h (Byte)	OP-Code =06h (Byte)
ORG block = 03h (Byte)	Ackn. block = 0Fh (Byte)
Length ORG block = 08h (Byte)	Length Ack. block = 03h (Byte)
ORG identifier* (Byte)	Error no. (Byte)
ERW identifier (Byte)	Empty block = FFh (Byte)
Start address (Word)	Length empty block = 07h (Byte)
Length (Word)	5 empty bytes attached
Empty block = FFh (Byte)	Data up to 64kByte
Length empty block = 02h (Byte)	(only if error no.=0)

*) More details to the data area is to be found at "ORG-Format" above.



Please regard that in opposite to Siemens-S5 systems, the block addressing of these CPUs takes the start address as byte number and the length as number of words.

Messages of error no.

The following messages can be returned via *error no.*:

Error no.	Message
00h	No error occurred
01h	The defined area cannot be read res. written

5.14 Example communication CPU 215-2BT16

Overview

This chapter provides an introduction to use the TCP/IP bus system for the System 200V. The object of this chapter is to create a small communication system between two VIPA CPUs 21xNET that provides a simple approach to the control of the communication processes.

Preconditions

Knowledge of the VIPA CP handling blocks AG_SEND and AG_RECV is required. CP handling blocks provide the options required to utilize the communication functions in the programs of the PLCs.

The minimum technical equipment required for the example is as follows:

- *Hardware*
 - 2 CPUs 21xNET from VIPA
 - 1 PC or PG with Twisted Pair Ethernet connection
- *Communication line*
 - 3 bus cables
 - 1 Switch/Hub
- *Addresses*
 - 2 IP Addresses and subnet masks for 2 CPs
- *Software package*
 - Siemens SIMATIC Manager V. 5.1 or higher
 - Siemens SIMATIC NET

The implementation of the example requires that the two CPUs be programmed as well as the configuration of the CPs by means of NetPro from Siemens.

Aufbau

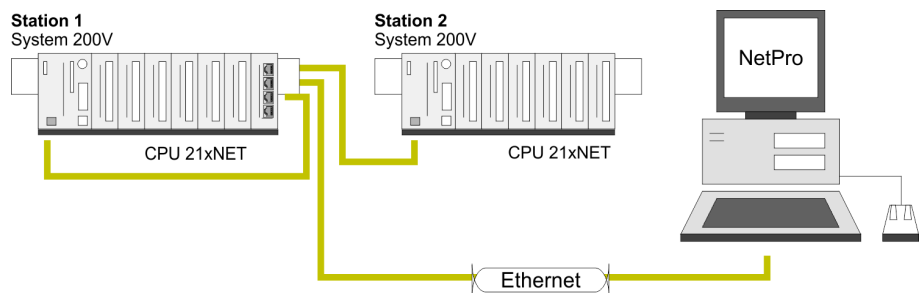

Station tasks

The example for the application is based upon a communication task that is described in detail in the following passage: Both of the CPUs contain the same PLC program, only the configuration of the CPs have to be adjusted. Both stations are sending and receiving 16 data words per second.

- Data block DB 11 transfers the data bytes DBB 0 to DBB 32 at an interval of 1s. Data byte DBB 0 in DB 11 is used as message counter. It is only incremented if the preceding transmit command was processed correctly (completed without error). The remaining data words (DBB 2 to DBB 32) can be used for the transfer of user data.
- The receiving station stores the data in DB 12 (DBB 0 to DBB 31).
- Using NetPro an active SEND/RECEIVE connection with ID 1 is to be configured for the CP. This Connection is established at station 2 as a passive SEND/RECEIVE connection.
- The source and destination parameters must be configured directly.

At this point the purpose and the required settings have been outlined. The program provide additional details of the configuration of the handler blocks. A detailed description follows.

Steps of project engineering

The project engineering is divided into the following steps:

- Hardware configuration
- CP Project engineering with NetPro
- PLC user application
- Transfer project

Hardware configuration Station 1

1. ▶ Start Siemens SIMATIC manager with new project.
2. ▶ Place a new System 300 station with **Insert > Station > SIMATIC 300 station** and rename it to "Station 1".
3. ▶ Activate the station "SIMATIC 300" and open the hardware configurator by clicking on "Hardware".
4. ▶ Configure a rack (SIMATIC 300 \ Rack-300 \ Profile rail).
5. ▶ Engineer in deputy of your CPU 21xNET the Siemens CPU 315-2DP (6ES7 315-2AG10-0AB0 V2.6.), which is to be found at SIMATIC 300 \ CPU 300 \ CPU 315-2DP. If needed, parameterize the CPU 315-2DP.
6. ▶ Configure in deputy of your CP the Siemens-CP CP343-1 (343-1EX11) at slot 4, to be found at SIMATIC 300 \ CP 300 \ Industrial Ethernet \ CP 343-1.
7. ▶ Set IP address, subnet mask and gateway at "CP properties".
8. ▶ Here it is not necessary to configure the System 200V modules by means of a virtual PROFIBUS system.

Hardware configuration Station 2

1. ▶ Create, following the approach above, a hardware configuration for the destination CPU and assign the name "Station 2".
⇒ For the CP, use the IP addresses, subnet masks and gateways assigned to Station 2.
2. ▶ Save and compile your project.

Project engineering with NetPro

1. ▶ Start NetPro by selecting the CPU below *Station 1* and clicking on the object "connections". In NetPro "Station 1" and "Station 2" are listed together with Ethernet.

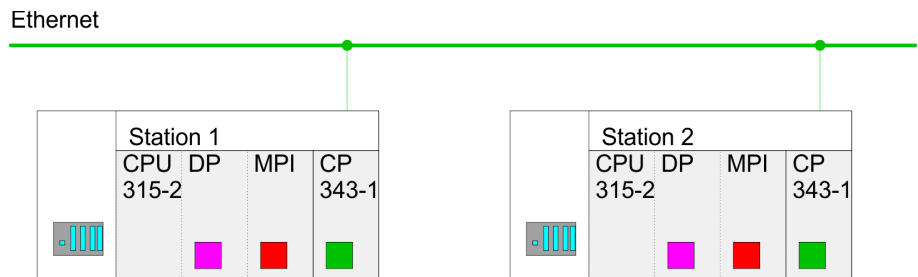

2. ▶ To configure the connection open the connection list. For this you choose the CPU of Station 1 and call *Insert new connection* via the context menu:

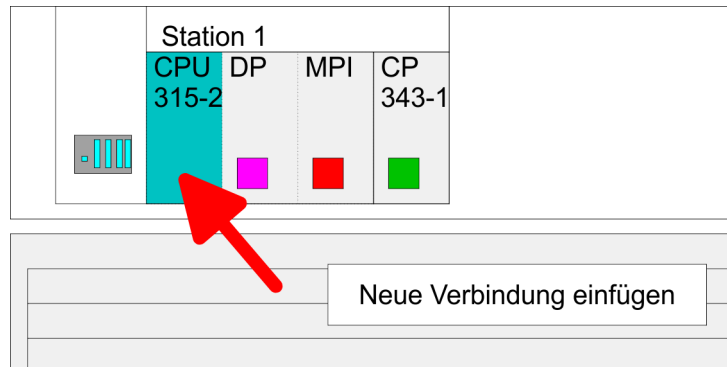

3. ▶ A dialog window appears where you can select the connection partner and the type of the connection. Configure the following connection:

⇒ *New connection*

Connection: TCP connection

Connection partner: Station 2 > CPU 315-2DP

Properties TCP connection

ID: 1

ID and *LADDR* are parameters that you have to define in your PLC program if using FC 5 (AG_SEND) and FC 6 (AG_RECEIVE).

Route:

The *Route* allows you to choose the CP that has to manage the connection. For the communication between the CPU 21xNET the route "CP 343-1 - (R0/S4)" is just right preset.

Active connection establishment: activated

4. ▶ Save and compile your connection.

PLC user program

For the processing of connection commands at the PLC, a PLC user program is necessary in the concerning CPU. For this only the handling blocks AG_SEND (FC 5) and AG_RECV (FC 6) are used. By including this blocks into the cycle block OB1 with the parameters ID and LADDR you may cyclically send and receive data. The two FCs are part of the VIPA library that is included in the consignment of the CPU as CD.

OB 1 Cycle

Via the Cycle OB 1 the sending and receiving of the data is controlled. The OB 1 that you may transfer into both CPUs has the following structure:

```

UN    T    1           // Timer 1 triggered sending
L     S5T#1S         // Send initiation every 1 sec
SV    T    1
S     M    10.0      // Init bit memory

CALL  "AG_SEND"

```

Example communication CPU 215-2BT16 > Monitoring the data transfer in the Siemens SIMATIC manager

```

ACT    :=M10.0           // Init bit memory
ID     :=1               // Connection number
LADDR :=W#16#110        // Module address
SEND  :=P#DB11.DBX0.0  // Send buffer area DB11
                                // Send 32 Byte (16 Words)
LEN    :=32
from DB11
DONE   :=M10.1
ERROR  :=#Senderror// Temporary error bit memory
STATUS:=MW12           // Order res. connection state
U      M      10.1      // Send ready?
SPBN   nDon
U      M      10.1      // Send ready?
R      M      10.0      // Set back init
U      #Senderror      // At send error
SPB    nDon           // Don't raise send counter
L      DB11.DBW 0      // Send counter in user data
                                // (DBW0)
L      1               // increment for 1 and
+I                                // store again in send buffer
T      DB11.DBW 0

nDon:
NOP    0               // Send not ready yet

// Cyclic call of the receive block

CALL   "AG_RECV"
ID     :=1             // Connection number
LADDR :=W#16#110      // Module address
RECV  :=P#DB12.DBX100.0  // Receive buffer
                                // Receive buffer
NDR   :=#Newdata      // NewDataReceived?
ERROR :=M0.1          // RecError
STATUS:=MW2           // Order res. connection state
LEN   :=#Reclen       // Really received length
NOP   0               // Reclen can be at ISO-on-TCP
< 32
U     #Newdata        // when new data received
ZV   Z      1         // Increment Receive counter
Counter1
L     Z      1         // reset counter 1 at overflow
L     999
==I
R     Z      1

```

5.14.1 Monitoring the data transfer in the Siemens SIMATIC manager

It is assumed, that the CPs are programmed and that an overall reset was issued to the CPUs, where the RUN/STOP switch must be located in STOP position. Now load the above PLC programs into both CPUs and switch them into RUN. Start the Siemens SIMATIC manager and execute the following steps to monitor the transmit job:

1. ► **PLC > Monitor/Modify Variables**
2. ► In the column "Operand" you have to enter the respective data block number and the data word (DB11.DBB 0-31).

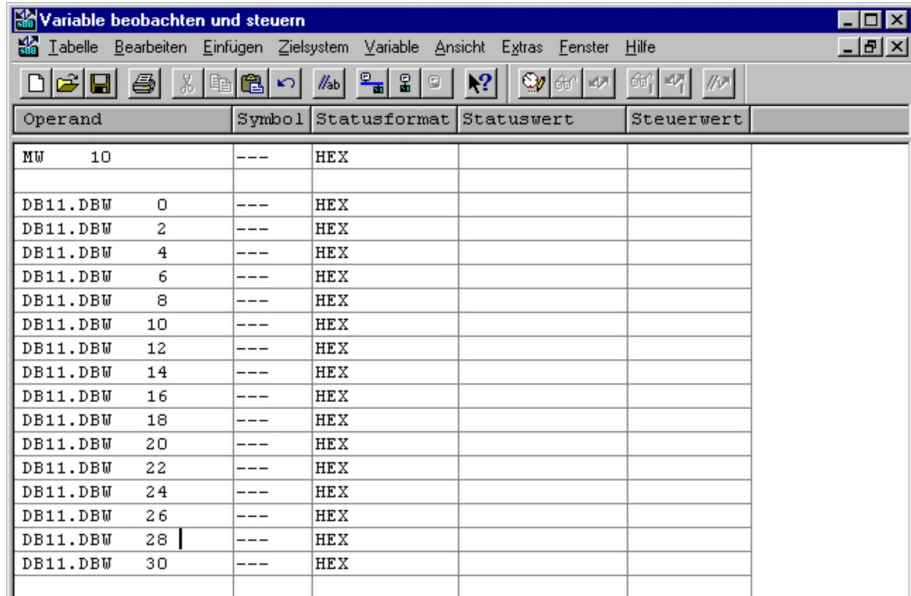

3. Establish a connection and click "monitor" .



Operand	Symbol	Statusformat	Statuswert	Steuerwert
MW 10		---	HEX	
DB11.DBW 0		---	HEX	
DB11.DBW 2		---	HEX	
DB11.DBW 4		---	HEX	
DB11.DBW 6		---	HEX	
DB11.DBW 8		---	HEX	
DB11.DBW 10		---	HEX	
DB11.DBW 12		---	HEX	
DB11.DBW 14		---	HEX	
DB11.DBW 16		---	HEX	
DB11.DBW 18		---	HEX	
DB11.DBW 20		---	HEX	
DB11.DBW 22		---	HEX	
DB11.DBW 24		---	HEX	
DB11.DBW 26		---	HEX	
DB11.DBW 28		---	HEX	
DB11.DBW 30		---	HEX	

Entering User data

You may enter user data starting with DBB 2. Place the cursor on *modify value* and enter the value you wish to transfer, e.g. W#16#1111.

The  button transfers the modify value in every cycle and the  button initiates a single transfer.

6 Configuration with TIA Portal

6.1 TIA Portal - Limitations

General

Since the VIPA-CPU is configured as CPU 315-2DP (6ES7 315-2AG10-0AB0 V2.6.) in the Siemens TIA Portal, there are limitations with the configuration of the VIPA-CPU, which are in the following described.

VIPA specific SFCs

The VIPA specific SFCs are not supported during programming with the Siemens TIA Portal.

Operating blocks - OBs

- OB 55 "Status interrupt" is not supported by the VIPA-CPU
- OB 56 "Update interrupt" is not supported by the VIPA-CPU
- OB 81 "Error in power supply" exists in the VIPA-CPU but is not supported by the Siemens TIA Portal
- The phase shift, available for the OB 35 "Watchdog" in the Siemens TIA Portal, is not evaluated by the VIPA-CPU.

Further limitations

- "Plant designation" and "location identifier" in the Siemens TIA Portal are not supported by the VIPA-CPU.
- In contrast to the Siemens CPU 315-2DP with a periphery address area 0 ... 2047, the periphery address area of the VIPA-CPU is limited to 0 ... 1023. The diagnostic address area is 0 ... 2047 and is not limited.
- The bit memory (retentive memory) area is limited to 0 ... 1023.

6.2 TIA Portal - Work environment

6.2.1 General

General

In this chapter the project engineering of the VIPA CPU in the Siemens TIA Portal is shown. Here only the basic usage of the Siemens TIA Portal together with a VIPA CPU is shown. Please note that software changes can not always be considered and it may thus be deviations to the description. TIA means **T**otally **I**ntegrated **A**utomation from Siemens. Here your VIPA PLCs may be configured and linked. For diagnostics online tools are available.



Information about the Siemens TIA Portal can be found in the online help respectively in the according online documentation.

Starting the TIA Portal

To start the Siemens TIA Portal with Windows select 'Start → Programs → Siemens Automation → TIA ...'

Then the TIA Portal opens with the last settings used.

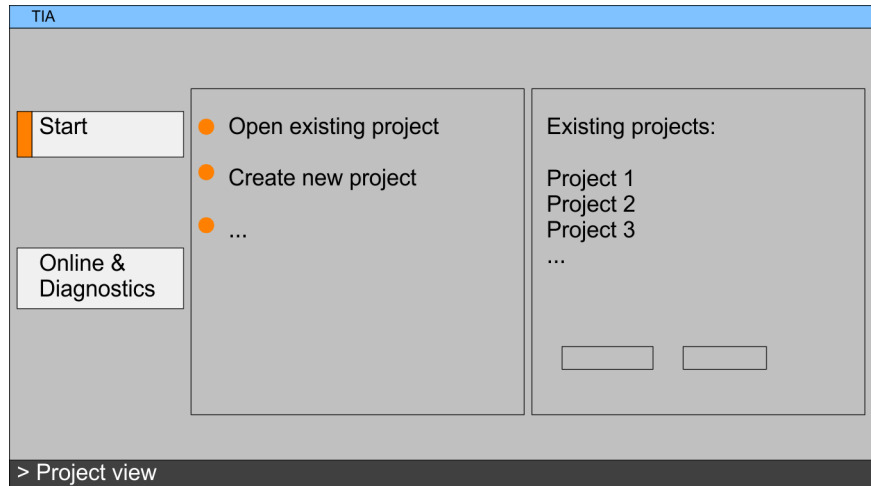

Exiting the TIA Portal

With the menu *'Project → Exit'* in the *'Project view'* you may exit the TIA Portal. Here there is the possibility to save changes of your project before.

6.2.2 Work environment of the TIA Portal

Basically, the TIA Portal has the following 2 views. With the button on the left below you can switch between these views:

Portal view

The *'Portal view'* provides a "task oriented" view of the tools for processing your project. Here you have direct access to the tools for a task. If necessary, a change to the Project view takes place automatically for the selected task.

Project view

The *'Project view'* is a "structured" view to all constituent parts of your project.

Areas of the Project view

The Project view is divided into the following areas:

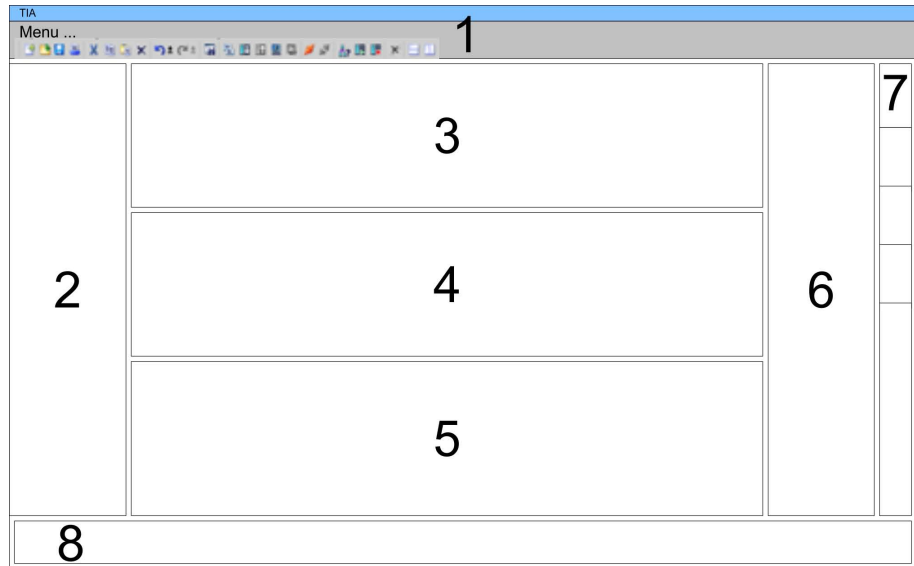

- 1 Menu bar with toolbars
- 2 Project tree with Details view
- 3 Project area
- 4 Device overview of the project respectively area for block programming
- 5 Properties dialog of a device (parameter) respectively information area
- 6 Hardware catalog and tools
- 7 "Task-Cards" to select hardware catalog, tasks and libraries
- 8 Jump to Portal or Project view

6.3 TIA Portal - Hardware configuration - CPU

General

The hardware configuration of the CPU and the system 200V modules at the VIPA bus takes place in the Siemens TIA Portal as a virtual PROFIBUS systems. For the PROFIBUS interface is standardized software sided, the functionality is guaranteed by including a GSD-file into the Siemens TIA Portal. Your project can be transferred to the CPU via MPI interface or by means of a MMC.

Including the GSD-file

1. ➤ Go to www.vipa.com > Service > Download > PROFIBUS GSD files and download the file *System_100V_-_200V_Vxxx.zip*.
2. ➤ Extract the file to your work directory. The *vipa_21x.gsd* (German) respectively *vipa_21x.gse* (English) can be found at the directory *CPU21x*.
3. ➤ Start the Siemens hardware configurator and close every project.
4. ➤ Go to **Options** > *Install new GSD file*.
5. ➤ Navigate to the directory *CPU21x* and choose the corresponding file **vipa_21x.gsd** (German) or **vipa_21x.gse** (English)
 - ⇒ Now the modules of the VIPA System 200V are integrated in the *hardware catalog* at *PROFIBUS-DP \ Additional field devices \ I/O \ VIPA_System_200V*.

Configuration Siemens CPU

With the Siemens TIA Portal the CPU from VIPA is to be configured as CPU 315-2DP (6ES7 315-2AG10-0AB0 V2.6.) from Siemens.

1. ▶ Start the Siemens TIA Portal.
2. ▶ Create a new project in the *Portal view* with 'Create new project'.
3. ▶ Switch to the *Project view*.
4. ▶ Click in the *Project tree* at 'Add new device'.
5. ▶ Select the following CPU in the input dialog:
SIMATIC S7-300 > CPU 315-2DP (6ES7 315-2AG10-0AB0 V2.6.)
⇒ The CPU is inserted with a profile rail.

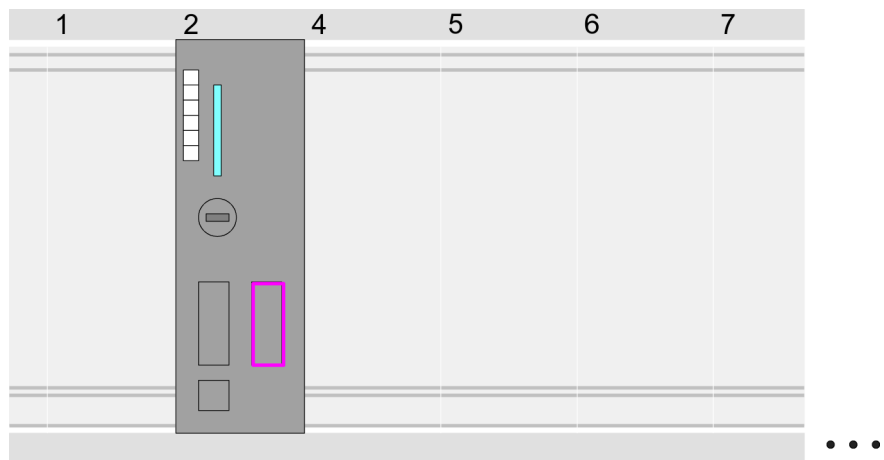

Device overview:

Module	...	Slot	...	Type	...
PLC ...		2		CPU 315-2DP	
MPI interface		2 0		MPI interface	
DP interface		2 X2		DP interface	
...		

Setting standard CPU parameters

Since the CPU from VIPA is configured as Siemens CPU, so the setting of the parameters takes place via the Siemens CPU. For parametrization click in the *Project area* respectively in the *Device overview* at the CPU part. Then the parameters of the CPU part are shown in the *Properties dialog*. Here you can make your parameter settings. ↪ 'Parameter CPU' on page 44

6.3.1 Virtual PROFIBUS master system

Configure a PROFIBUS master system

- ▶ Connect and parameterize the internal DP interface at operation mode "DP-Master".

VIPA_CPU21x

1. Switch in the *Project area* to "Network view".
2. Connect the slave system "VIPA_CPU 21x". After installing the vipa_21x.GSD this may be found in the hardware catalog at:
Other field devices > PROFIBUS DP > I/O > VIPA GmbH > VIPA_System_200V > VIPA_CPU21x.
3. For the slave system CPU21x-Slave-System set the PROFIBUS address 1.

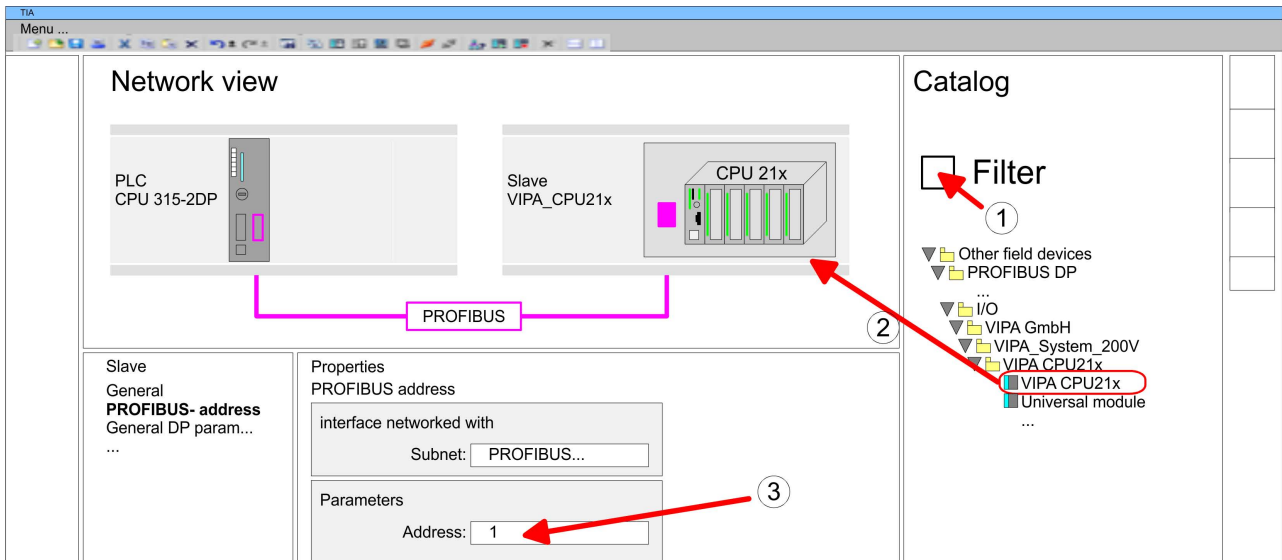

i Thus, the VIPA components can be displayed, you have to deactivate the "Filter" of the hardware catalog.

1. Click at the slave system and open the "Device overview" in the *Project area*.
2. Configure at slot 1 the according CPU 215-2BT16 of the hardware catalog of the VIPA_System_200V.

Device overview:

Module	...	Slot	...	Type	...
Slave ...		0		VIPA CPU21x	
215-2BT16		1		215-2BT16	
		2			

Configuration of the DP slaves

1. Install the corresponding GSD file of your slave system in the hardware configurator.
2. Search the corresponding PROFIBUS DP slave in the hardware catalog and drag&drop it to the subnet of your master.
3. Assign a valid PROFIBUS address > 2 to the DP slave.

4. Add your modules according to the real hardware assembly.

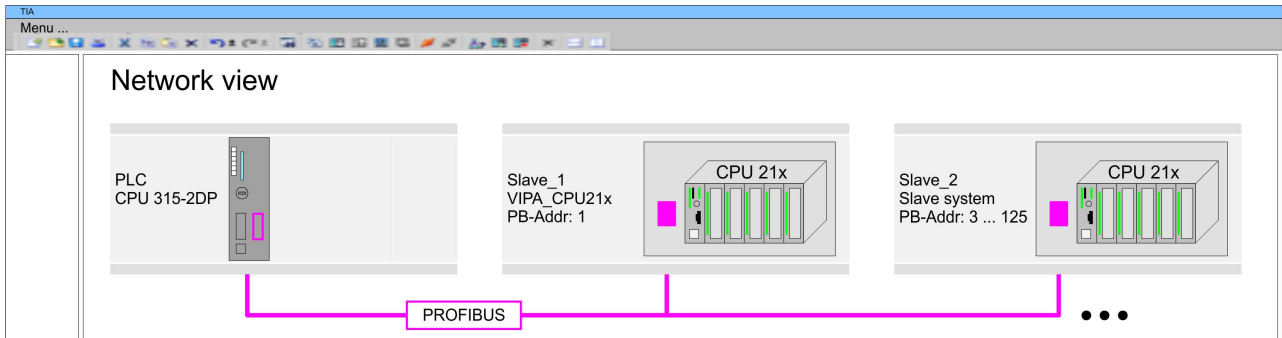

6.4 TIA Portal - Hardware configuration - I/O modules

Hardware configuration of the modules

After the hardware configuration of the CPU place the System 300 modules at the bus in the plugged sequence. For this drag&drop the according module from the Hardware catalog to the according position of the profile rail in the *Project area* or in the *Device overview*

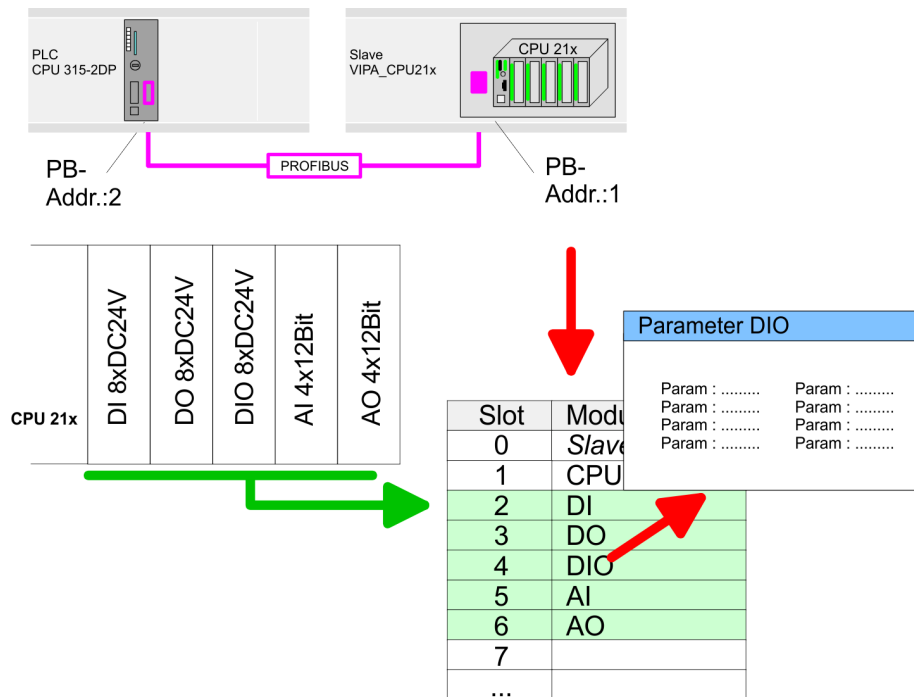

Device overview

Module	...	Slot	...	Type	...
PLC...		1		CPU ...	
DI...		2		DI...	
DO...		3		DO...	
DIO...		4		DIO...	
AI...		5		AI...	

AO...		6		AO...	
...		...			

Parametrization

For parametrization click in the *Project area* respectively in the *Device overview* on the module you want to parameterize. The parameters of the module appear in the Properties dialog. Here you can make your parameter settings.

6.5 TIA Portal - Hardware configuration - Ethernet PG/OP channel

Overview

The CPU has an integrated Ethernet PG/OP channel. This channel allows you to program and remote control your CPU.

- The Ethernet PG/OP channel also gives you access to the internal web page that contains information about firmware version, connected I/O devices, current cycle times etc.
- At the first commissioning respectively after a factory reset the Ethernet PG/OP channel has no IP address.
- For online access to the CPU via the Ethernet PG/OP channel, valid IP address parameters have to be assigned to this. This is called "initialization".
- This can be done with the Siemens TIA Portal.

Assembly and commissioning

1. ➤ Install your System 300S with your CPU.
2. ➤ Wire the system by connecting cables for voltage supply and signals.
3. ➤ Connect the Ethernet jack of the Ethernet PG/OP channel to Ethernet.
4. ➤ Switch on the power supply.
 - ⇒ After a short boot time the CP is ready for communication. He possibly has no IP address data and requires an initialization.

"Initialization" via Online functions

The initialization via the Online functions takes place with the following proceeding:

- Determine the current Ethernet (MAC) address of your Ethernet PG/OP channel. This can be found as 1. address under the front flap of the CPU on a sticker on the left side.

Assign IP address parameters

You get valid IP address parameters from your system administrator. The assignment of the IP address data happens online in the Siemens TIA Portal with the following proceeding:

1. ➤ Start the Siemens TIA Portal.
2. ➤ Switch to the *'Project view'*.
3. ➤ Click in the *'Project tree'* at *'Online access'* and choose here by a doubleclick your network card, which is connected to the Ethernet PG/OP channel.

4. ▶ To get the stations and their MAC address, use the 'Accessible device'. The MAC address can be found at the 1. label beneath the front flap of the CPU.
5. ▶ Choose from the list the module with the known MAC address (Onboard PG/OP [MAC address]) and open with "Online & Diagnostics" the diagnostics dialog in the Project area.
6. ▶ Navigate to *Functions > Assign IP address*. Type in the IP configuration like IP address, subnet mask and gateway.
7. ▶ Confirm with [Assign IP configuration].
 - ⇒ Directly after the assignment the Ethernet PG/OP channel is online reachable using the set IP address data. The value remains as long as it is reassigned, it is overwritten by a hardware configuration or an factory reset is executed.

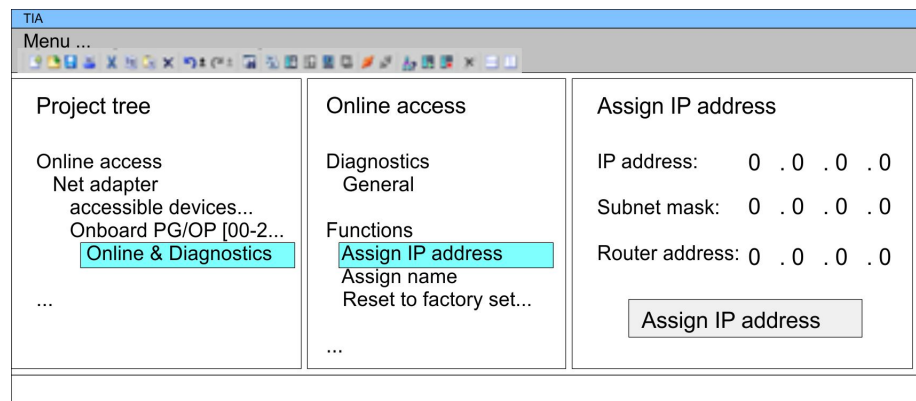

Due to the system you may get a message that the IP address could not be assigned. This message can be ignored.

Take IP address parameters in project

1. ▶ Open your project.
2. ▶ If not already done, configure in the 'Device configuration' a Siemens CPU 315-2DP (6ES7 315-2AG10-0AB0 V2.6.).
3. ▶ Configure the System 200V modules.
4. ▶ For the Ethernet PG/OP channel you have to configure a Siemens CP 343-1 (6GK7 343-1EX11 0XE0) always as last module after the really plugged modules.
5. ▶ Open the "Property" dialog by clicking on the CP 343-1EX11 and enter for the CP at "Properties" at "Ethernet address" the IP address data, which you have assigned before.
6. ▶ Transfer your project.

TIA Portal - Project transfer

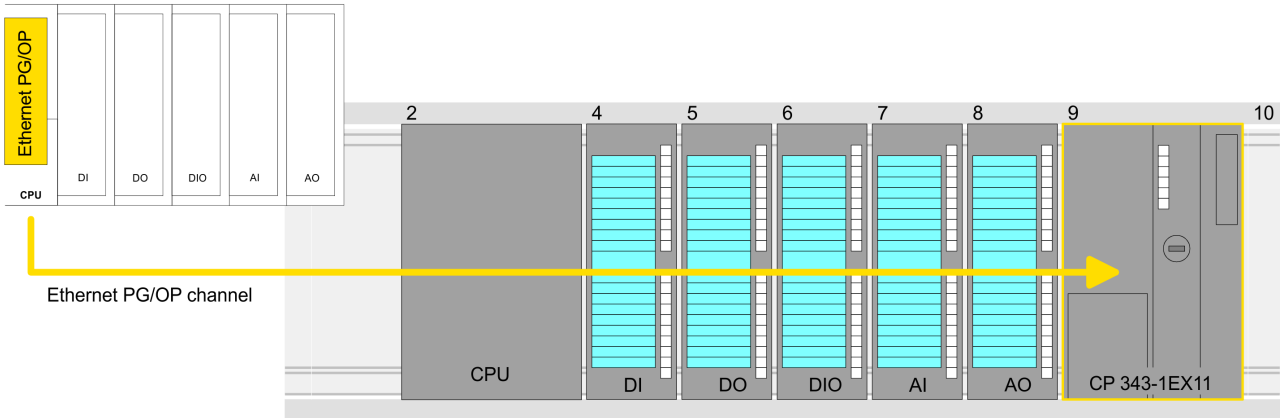

Device overview:

Module	...	Slot	...	Type	...
PLC...		1		CPU ...	
...		
DI...		2		DI...	
DO...		3		DO...	
DIO...		4		DIO...	
AI...		5		AI...	
AO...		6		AO...	
■ CP 343-1		7		CP 343-1	

6.6 TIA Portal - Project transfer

Overview

There are the following possibilities for project transfer into the CPU:

- Transfer via MPI
- Transfer via Ethernet
- Transfer via memory card

Transfer via MPI

Currently the VIPA programming cables for transfer via MPI are not supported. This is only possible with the programming cable from Siemens.

1. ➤ Establish a connection to the CPU via MPI with an appropriate programming cable. Information may be found in the corresponding documentation of the programming cable.
2. ➤ Switch-ON the power supply of your CPU and start the Siemens TIA Portal with your project.
3. ➤ Select in the *Project tree* your CPU and choose 'Context menu ➔ Download to device ➔ Hardware configuration' to transfer the hardware configuration.
4. ➤ To transfer the PLC program choose 'Context menu ➔ Download to device ➔ Software'. Due to the system you have to transfer hardware configuration and PLC program separately.

Transfer via Ethernet

For transfer via Ethernet the CPU has the following interface:

- Ethernet PG/OP channel

Initialization

So that you may the according Ethernet interface, you have to assign IP address parameters by means of the "initialization".

Please consider to use the same IP address data in your project for the CP 343-1.

Transfer

1. ▶ For the transfer, connect, if not already done, the appropriate Ethernet jack to your Ethernet.
 2. ▶ Open your project with the Siemens TIA Portal.
 3. ▶ Click in the *Project tree* at *Online access* and choose here by a double-click your network card, which is connected to the Ethernet PG/OP interface.
 4. ▶ Select in the *Project tree* your CPU and click at [Go online].
 5. ▶ Set the access path by selecting "PN/IE" as type of interface, your network card and the according subnet. Then a net scan is established and the corresponding station is listed.
 6. ▶ Establish with [Connect] a connection.
 7. ▶ Click to '*Online → Download to device*'.
- ⇒ The according block is compiled and by a request transferred to the target device. Provided that no new hardware configuration is transferred to the CPU, the entered Ethernet connection is permanently stored in the project as transfer channel.

Transfer via memory card

The memory card serves as external storage medium. There may be stored several projects and sub-directories on a memory card. Please regard that your current project is stored in the root directory and has one of the following file names:

- S7PROG.WLD
- AUTOLOAD.WLD

1. ▶ Create in the Siemens TIA Portal a wld file with '*Project → Memory card file → New*'.
⇒ The wld file is shown in the *Project tree* at "SIMATIC Card Reader" as "Memory card file".
2. ▶ Copy the blocks from the *Program blocks* to the wld file. Here the hardware configuration data are automatically copied to the wld file as "System data".

**Transfer memory card
→ CPU**

The transfer of the application program from the memory card into the CPU takes place depending on the file name after an overall reset or PowerON.

- *S7PROG.WLD* is read from the memory card after overall reset.
- *AUTOLOAD.WLD* is read from the memory card after PowerON.

The blinking of the MC LED of the CPU marks the active transfer. Please regard that your user memory serves for enough space for your user program, otherwise your user program is not completely loaded and the SF LED gets on.

**Transfer CPU →
Memory card**

When a memory card has been installed, the write command stores the content of the RAM as S7PROG.WLD on the memory card. The write command can be found in the Siemens TIA Portal in the Task card "Online tools" in the command area at "Memory" as button [Copy RAM to ROM]. The MC LED blinks during the write access. When the LED expires, the write process is finished. If this project is to be loaded automatically from the memory card with PowerON, you have to rename this to on the memory card to *AUTOLOAD.WLD*.



Please note that in the Siemens TIA Portal with some CPU types the [Copy RAM to ROM] button is not available.

**Checking the transfer
operation**

After accessing the memory card you can find a diagnostics entry in the CPU. To monitor the diagnostics entries, you select *Online & Diagnostics* in the Siemens TIA Portal. Here you can access the "Diagnostics buffer". ↪ *'Diagnostic entries' on page 56*