

VIPA System 200V

IM | Manual

HB97E_IM | RE_253-1DN00 | Rev. 12/44

November 2012



Copyright © VIPA GmbH. All Rights Reserved.

This document contains proprietary information of VIPA and is not to be disclosed or used except in accordance with applicable agreements.

This material is protected by the copyright laws. It may not be reproduced, distributed, or altered in any fashion by any entity (either internal or external to VIPA), except in accordance with applicable agreements, contracts or licensing, without the express written consent of VIPA and the business management owner of the material.

For permission to reproduce or distribute, please contact:
VIPA, Gesellschaft für Visualisierung und Prozessautomatisierung mbH
Ohmstraße 4, D-91074 Herzogenaurach, Germany
Tel.: +49 (91 32) 744 -0
Fax.: +49 9132 744 1864
EMail: info@vipa.de
<http://www.vipa.com>

Note

Every effort has been made to ensure that the information contained in this document was complete and accurate at the time of publishing. Nevertheless, the authors retain the right to modify the information. This customer document describes all the hardware units and functions known at the present time. Descriptions may be included for units which are not present at the customer site. The exact scope of delivery is described in the respective purchase contract.

CE Conformity Declaration

Hereby, VIPA GmbH declares that the products and systems are in compliance with the essential requirements and other relevant provisions.

Conformity is indicated by the CE marking affixed to the product.

Conformity Information

For more information regarding CE marking and Declaration of Conformity (DoC), please contact your local VIPA customer service organization.

Trademarks

VIPA, SLIO, System 100V, System 200V, System 300V, System 300S, System 400V, System 500S and Commander Compact are registered trademarks of VIPA Gesellschaft für Visualisierung und Prozessautomatisierung mbH.

SPEED7 is a registered trademark of profichip GmbH.

SIMATIC, STEP, SINEC, TIA Portal, S7-300 and S7-400 are registered trademarks of Siemens AG.

Microsoft und Windows are registered trademarks of Microsoft Inc., USA.

Portable Document Format (PDF) and Postscript are registered trademarks of Adobe Systems, Inc.

All other trademarks, logos and service or product marks specified herein are owned by their respective companies.

Information product support

Contact your local VIPA Customer Service Organization representative if you wish to report errors or questions regarding the contents of this document. If you are unable to locate a customer service center, contact VIPA as follows:

VIPA GmbH, Ohmstraße 4, 91074 Herzogenaurach, Germany

Telefax: +49 9132 744 1204
EMail: documentation@vipa.de

Technical support

Contact your local VIPA Customer Service Organization representative if you encounter problems with the product or have questions regarding the product. If you are unable to locate a customer service center, contact VIPA as follows:

VIPA GmbH, Ohmstraße 4, 91074 Herzogenaurach, Germany

Telephone: +49 9132 744 1150 (Hotline)
EMail: support@vipa.de

Contents

About this manual	1
Safety information	2
Chapter 1 Basics and Assembly	1-1
Safety Information for Users.....	1-2
System conception	1-3
Dimensions	1-5
Installation	1-7
Demounting and module exchange	1-11
Wiring.....	1-12
Installation guidelines	1-14
General data	1-17
Chapter 2 Hardware description	2-1
Properties.....	2-2
Structure	2-3
Technical data.....	2-5
Chapter 3 Deployment	3-1
Basics DeviceNet	3-2
Configuration by means of the DeviceNet-Manager	3-4
Specifying baudrate and DeviceNet address	3-5
Test in conjunction with the DeviceNet.....	3-6
Module configuration in the DeviceNet-Manager	3-7
I/O addressing of the DeviceNet scanner	3-12
Diagnostics.....	3-13

About this manual

This manual describes the System 200V DeviceNet slave module IM 253-1DN00 from VIPA. Here you may find every information for commissioning and operation.

Overview

Chapter 1: Basics and Assembly

The focus of this chapter is on the introduction of the VIPA System 200V. Here you will find the information required to assemble and wire a controller system consisting of System 200V components.

Besides the dimensions the general technical data of System 200V will be found.

Chapter 2: Hardware description

Here the hardware components of the IM 253-1DN00 are described. The technical data are at the end of the chapter.

Chapter 3: Deployment

This chapter contains the description of the VIPA DeviceNet slave. Another section of this chapter concerns the configuration by means of the *DeviceNet-Manager* of Allen - Bradley. This section describes the configuration of the DeviceNet coupler and the System 200V modules. A summary of the diagnostic messages conclude the chapter.

Objective and contents

This manual describes the System 200V DeviceNet slave module IM 253-1DN00 from VIPA. It contains a description of the construction, project implementation and usage.

This manual is part of the documentation package with order number HB97E_IM and relevant for:

Product	Order number	as of state: HW
IM 253DN	VIPA 253-1DN00	03

Target audience

The manual is targeted at users who have a background in automation technology.

Structure of the manual

The manual consists of chapters. Every chapter provides a self-contained description of a specific topic.

Guide to the document

The following guides are available in the manual:

- an overall table of contents at the beginning of the manual
- an overview of the topics for every chapter

Availability

The manual is available in:

- printed form, on paper
- in electronic form as PDF-file (Adobe Acrobat Reader)

Icons Headings

Important passages in the text are highlighted by following icons and headings:



Danger!

Immediate or likely danger.
Personal injury is possible.



Attention!

Damages to property is likely if these warnings are not heeded.



Note!

Supplementary information and useful tips.

Safety information

Applications conforming with specifications

The IM 253DN is constructed and produced for:

- all VIPA System 200V components
- communication and process control
- general control and automation applications
- industrial applications
- operation within the environmental conditions specified in the technical data
- installation into a cubicle



Danger!

This device is not certified for applications in

- in explosive environments (EX-zone)

Documentation

The manual must be available to all personnel in the

- project design department
- installation department
- commissioning
- operation



The following conditions must be met before using or commissioning the components described in this manual:

- Hardware modifications to the process control system should only be carried out when the system has been disconnected from power!
- Installation and hardware modification only by properly trained personnel.
- The national rules and regulations of the respective country must be satisfied (installation, safety, EMC ...)

Disposal

National rules and regulations apply to the disposal of the unit!

Chapter 1 Basics and Assembly

Overview The focus of this chapter is on the introduction of the VIPA System 200V. Here you will find the information required to assemble and wire a controller system consisting of System 200V components. Besides the dimensions the general technical data of System 200V will be found.

Contents	Topic	Page
	Chapter 1 Basics and Assembly	1-1
	Safety Information for Users	1-2
	System conception	1-3
	Dimensions	1-5
	Installation	1-7
	Demounting and module exchange	1-11
	Wiring.....	1-12
	Installation guidelines	1-14
	General data	1-17

Safety Information for Users

Handling of electrostatic sensitive modules

VIPA modules make use of highly integrated components in MOS-Technology. These components are extremely sensitive to over-voltages that can occur during electrostatic discharges.

The following symbol is attached to modules that can be destroyed by electrostatic discharges.



The Symbol is located on the module, the module rack or on packing material and it indicates the presence of electrostatic sensitive equipment.

It is possible that electrostatic sensitive equipment is destroyed by energies and voltages that are far less than the human threshold of perception. These voltages can occur where persons do not discharge themselves before handling electrostatic sensitive modules and they can damage components thereby, causing the module to become inoperable or unusable.

Modules that have been damaged by electrostatic discharges can fail after a temperature change, mechanical shock or changes in the electrical load.

Only the consequent implementation of protection devices and meticulous attention to the applicable rules and regulations for handling the respective equipment can prevent failures of electrostatic sensitive modules.

Shipping of electrostatic sensitive modules

Modules must be shipped in the original packing material.

Measurements and alterations on electrostatic sensitive modules

When you are conducting measurements on electrostatic sensitive modules you should take the following precautions:

- Floating instruments must be discharged before use.
- Instruments must be grounded.

Modifying electrostatic sensitive modules you should only use soldering irons with grounded tips.



Attention!

Personnel and instruments should be grounded when working on electrostatic sensitive modules.

System conception

Overview

The System 200V is a modular automation system for assembly on a 35mm profile rail. By means of the peripheral modules with 4, 8 and 16 channels this system may properly be adapted matching to your automation tasks.

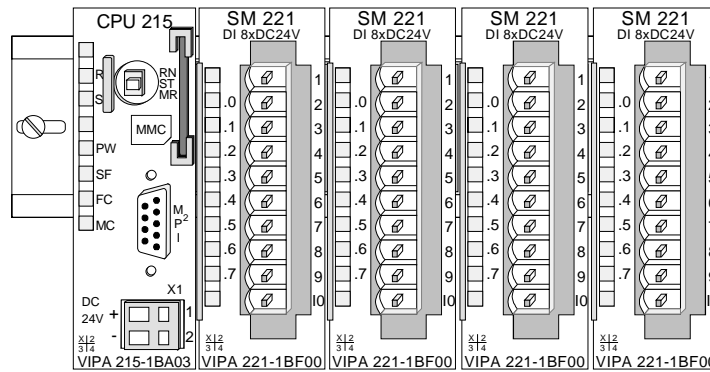

Components

The System 200V consists of the following components:

- Head modules like CPU and bus coupler
- Periphery modules like I/O, function und communication modules
- Power supplies
- Extension modules

Head modules

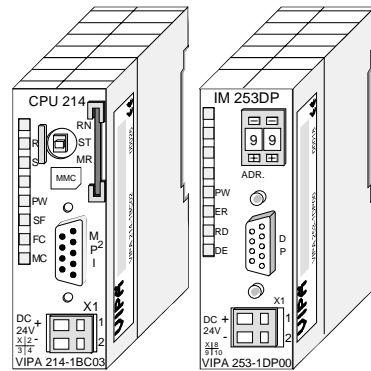

With a head module CPU respectively bus interface and DC 24V power supply are integrated to one casing.

Via the integrated power supply the CPU respectively bus interface is power supplied as well as the electronic of the connected periphery modules.

Periphery modules

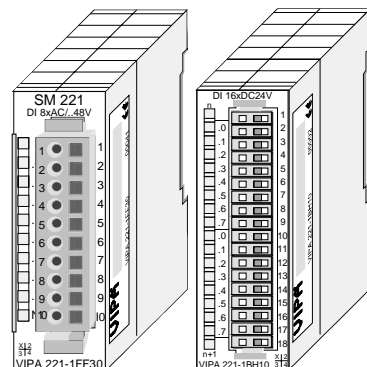

The modules are direct installed on a 35mm profile rail and connected to the head module by a bus connector, which was mounted on the profile rail before.

Most of the periphery modules are equipped with a 10pin respectively 18pin connector. This connector provides the electrical interface for the signaling and supplies lines of the modules.

Power supplies

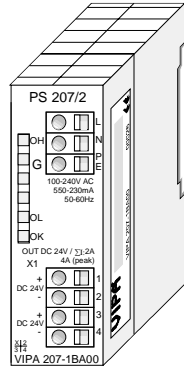

With the System 200V the DC 24V power supply can take place either externally or via a particularly for this developed power supply.

The power supply may be mounted on the profile rail together with the System 200V modules. It has no connector to the backplane bus.

Expansion modules

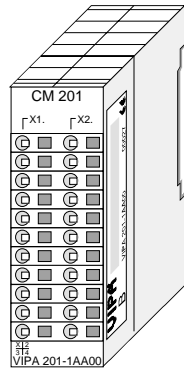

The expansion modules are complementary modules providing 2- or 3wire connection facilities.

The modules are not connected to the backplane bus.

Structure/ dimensions

- Profile rail 35mm
- Dimensions of the basic enclosure:
 - 1tier width: (HxWxD) in mm: 76x25.4x74 in inches: 3x1x3
 - 2tier width: (HxWxD) in mm: 76x50.8x74 in inches: 3x2x3

Installation

Please note that you can only install head modules, like the CPU, the PC and couplers at slot 1 or 1 and 2 (for double width modules).

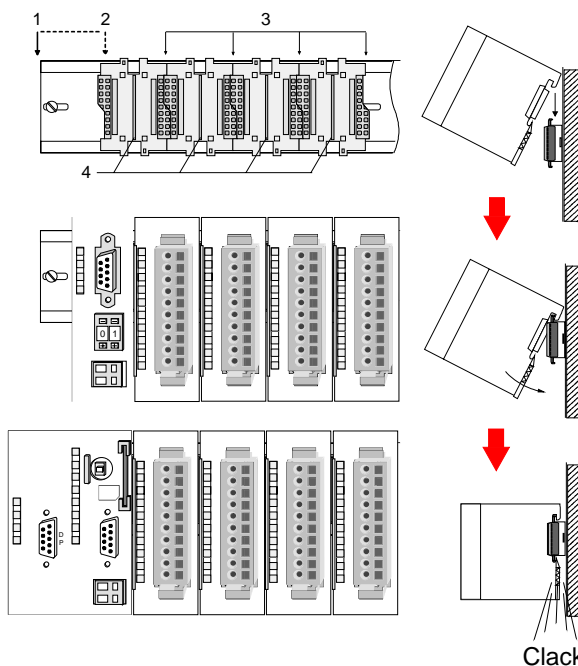

[1]	Head module (double width)
[2]	Head module (single width)
[3]	Periphery module
[4]	Guide rails

Note

Information about the max. number of pluggable modules and the max. current at the backplane bus can be found in the "Technical Data" of the according head module.

Please install modules with a high current consumption directly beside the head module.

Dimensions

Dimensions
Basic enclosure

1tier width (HxWxD) in mm: 76 x 25.4 x 74
2tier width (HxWxD) in mm: 76 x 50.8 x 74

Installation
dimensions

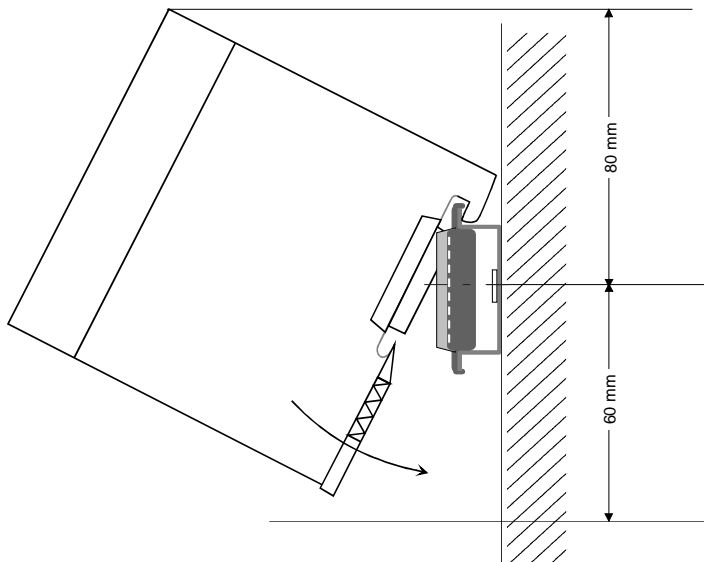

Installed and wired
dimensions

In- / Output
modules

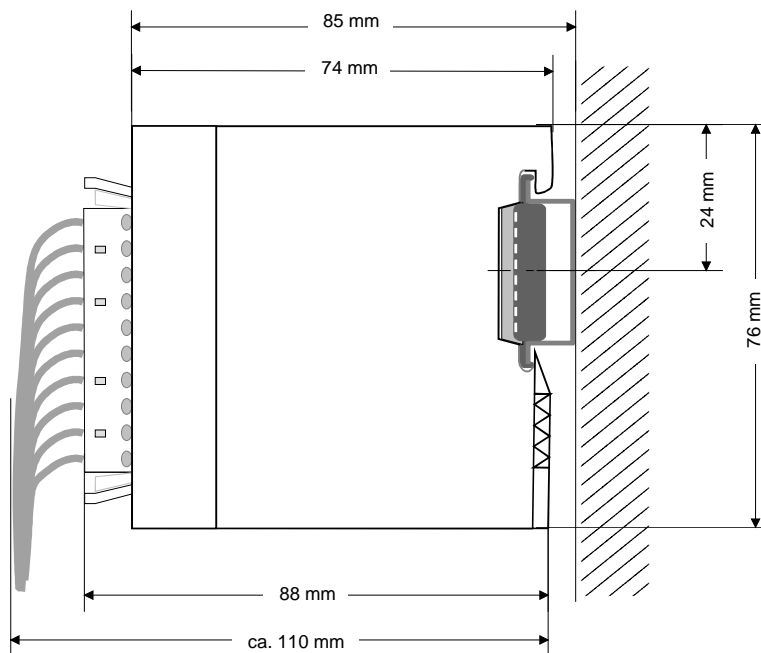

Function modules/
Extension modules

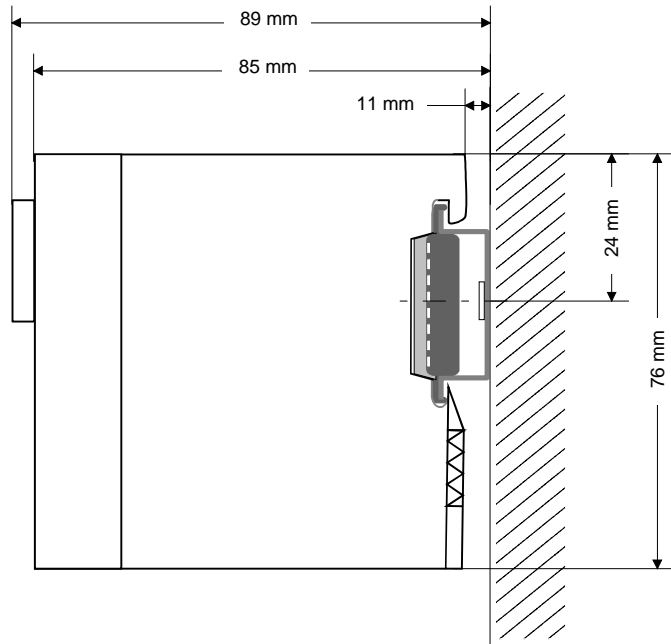

CPUs (here with
EasyConn from
VIPA)

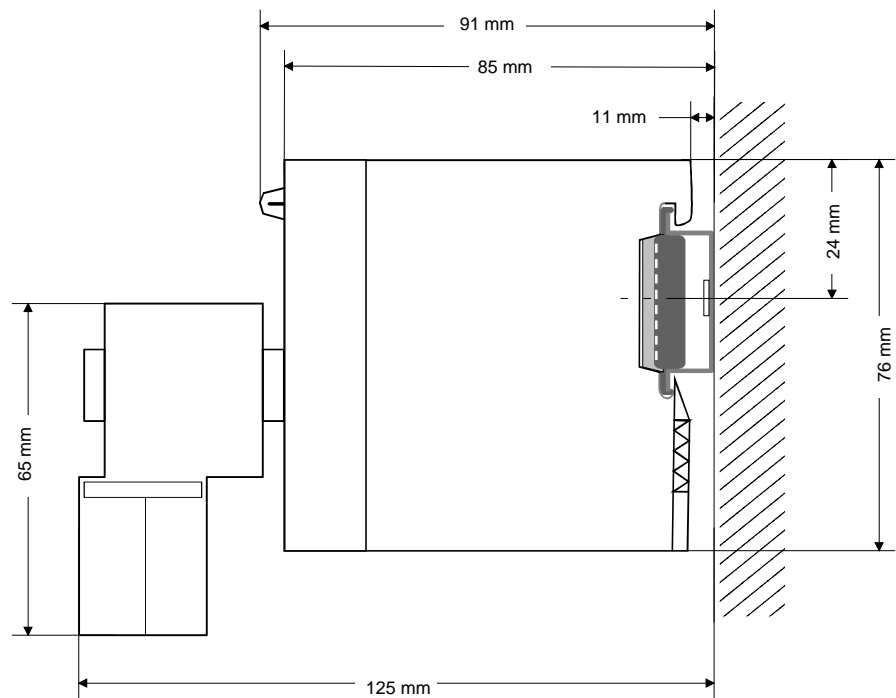

Installation

General

The modules are each installed on a 35mm profile rail and connected via a bus connector. Before installing the module the bus connector is to be placed on the profile rail before.

Profile rail

For installation the following 35mm profile rails may be used:

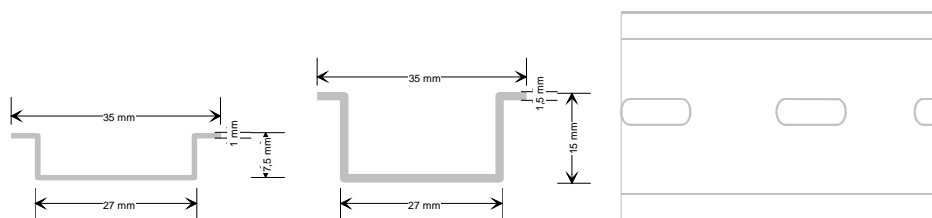

Order number	Label	Description
290-1AF00	35mm profile rail	Length 2000mm, height 15mm
290-1AF30	35mm profile rail	Length 530mm, height 15mm

Bus connector

System 200V modules communicate via a backplane bus connector. The backplane bus connector is isolated and available from VIPA in of 1-, 2-, 4- or 8tier width.

The following figure shows a 1tier connector and a 4tier connector bus:

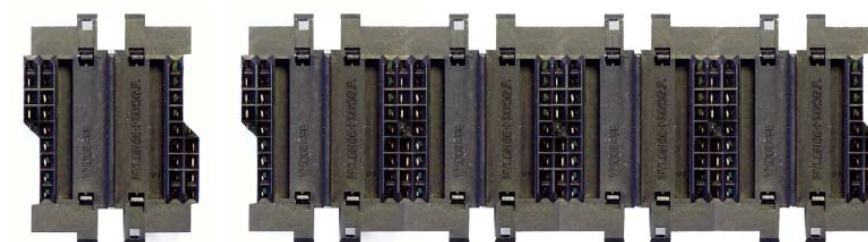

The bus connector is to be placed on the profile rail until it clips in its place and the bus connections look out from the profile rail.

Order number	Label	Description
290-0AA10	Bus connector	1tier
290-0AA20	Bus connector	2tier
290-0AA40	Bus connector	4tier
290-0AA80	Bus connector	8tier

Installation on a profile rail

The following figure shows the installation of a 4tier width bus connector in a profile rail and the slots for the modules.

The different slots are defined by guide rails.

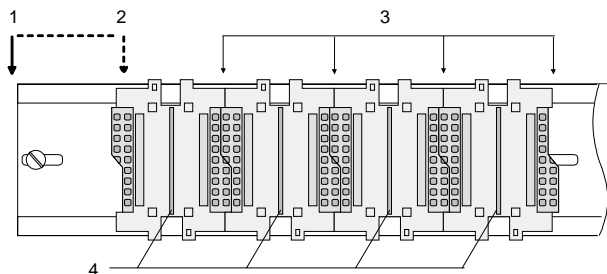

- [1] Head module (double width)
- [2] Head module (single width)
- [3] Peripheral module
- [4] Guide rails

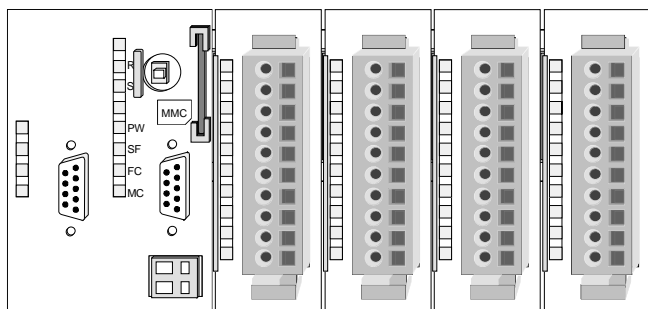
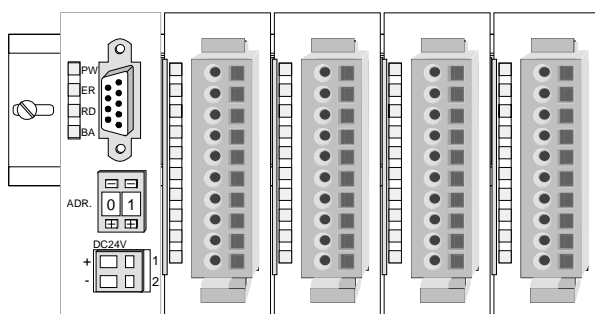

Assembly regarding the current consumption

- Use bus connectors as long as possible.
- Sort the modules with a high current consumption right beside the head module. In the service area of www.vipa.com a list of current consumption of every System 200V module can be found.

Assembly possibilities

horizontal assembly

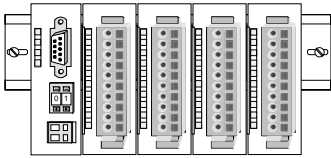

vertical assembly

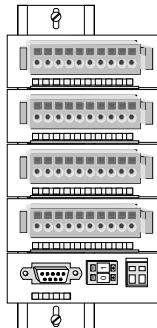

lying assembly

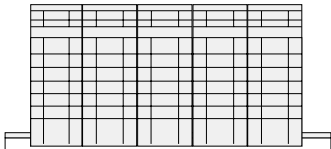

Please regard the allowed environmental temperatures:

- horizontal assembly: from 0 to 60°C
- vertical assembly: from 0 to 40°C
- lying assembly: from 0 to 40°C

The horizontal assembly always starts at the left side with a head module, then you install the peripheral modules beside to the right.

You may install up to 32 peripheral modules.

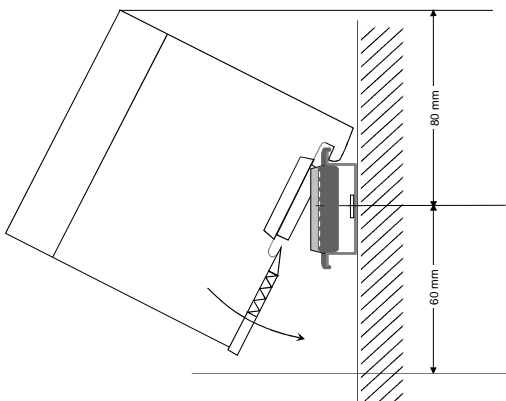

Please follow these rules during the assembly!

- Turn off the power supply before you install or remove any modules!
- Make sure that a clearance of at least 60mm exists above and 80mm below the middle of the profile rail.

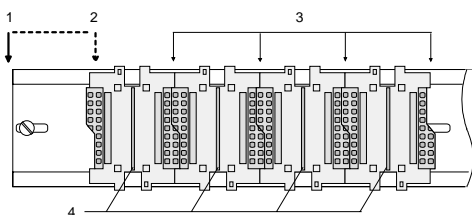

- Every row must be completed from left to right and it has to start with a head module.

- [1] Head module (double width)
- [2] Head module (single width)
- [3] Peripheral modules
- [4] Guide rails

- Modules are to be installed side by side. Gaps are not permitted between the modules since this would interrupt the backplane bus.
- A module is only installed properly and connected electrically when it has clicked into place with an audible click.
- Slots after the last module may remain unoccupied.



Note!

Information about the max. number of pluggable modules and the max. current at the backplane bus can be found in the "Technical Data" of the according head module.

Please install modules with a high current consumption directly beside the head module.

Assembly procedure

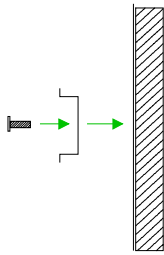

- Install the profile rail. Make sure that a clearance of at least 60mm exists above and 80mm below the middle of the profile rail.

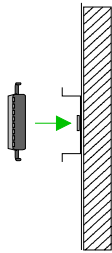

- Press the bus connector into the profile rail until it clips securely into place and the bus-connectors look out from the profile rail. This provides the basis for the installation of your modules.

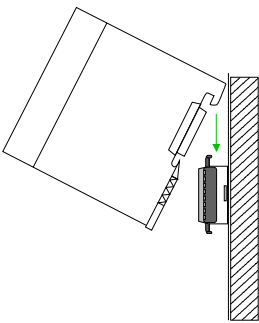

- Start at the outer left location with the installation of your head module and install the peripheral modules to the right of this.

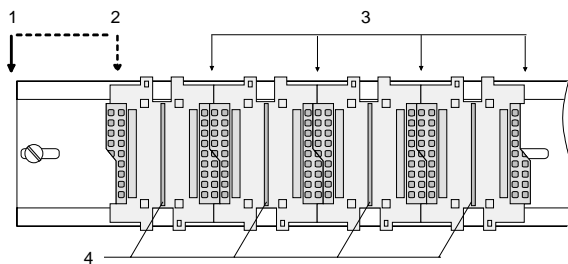

- [1] Head module (double width)
- [2] Head module (single width)
- [3] Peripheral module
- [4] Guide rails

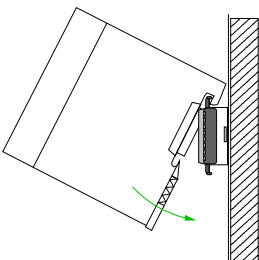

- Insert the module that you are installing into the profile rail at an angle of 45 degrees from the top and rotate the module into place until it clicks into the profile rail with an audible click. The proper connection to the backplane bus can only be guaranteed when the module has properly clicked into place.



Attention!

Power must be turned off before modules are installed or removed!

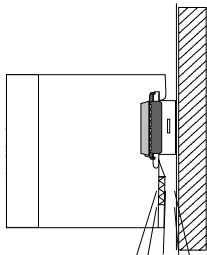

Clack

Demounting and module exchange

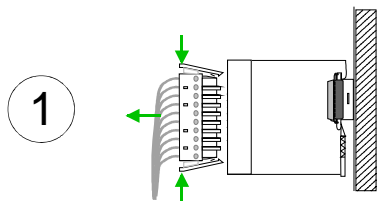

- Remove if exists the wiring to the module, by pressing both locking lever on the connector and pulling the connector.

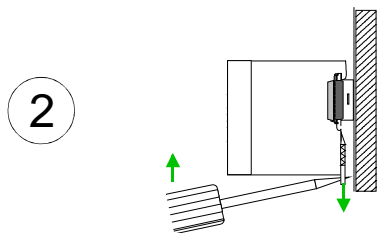

- The casing of the module has a spring loaded clip at the bottom by which the module can be removed.

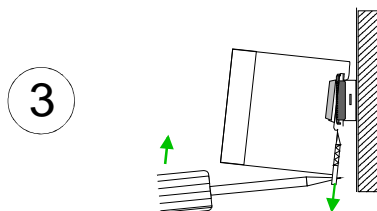

- The clip is unlocked by pressing the screwdriver in an upward direction.

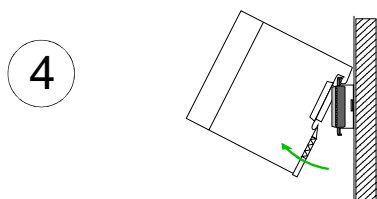

- Withdraw the module with a slight rotation to the top.

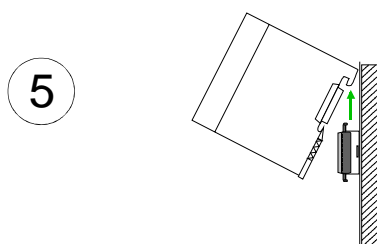

Attention!

Power must be turned off before modules are installed or removed!

Please regard that the backplane bus is interrupted at the point where the module was removed!

Wiring

Overview

Most peripheral modules are equipped with a 10pole or a 18pole connector. This connector provides the electrical interface for the signaling and supply lines of the modules.

The modules carry spring-clip connectors for interconnections and wiring.

The spring-clip connector technology simplifies the wiring requirements for signaling and power cables.

In contrast to screw terminal connections, spring-clip wiring is vibration proof. The assignment of the terminals is contained in the description of the respective modules.

You may connect conductors with a diameter from 0.08mm² up to 2.5mm² (max. 1.5mm² for 18pole connectors).

The following figure shows a module with a 10pole connector.

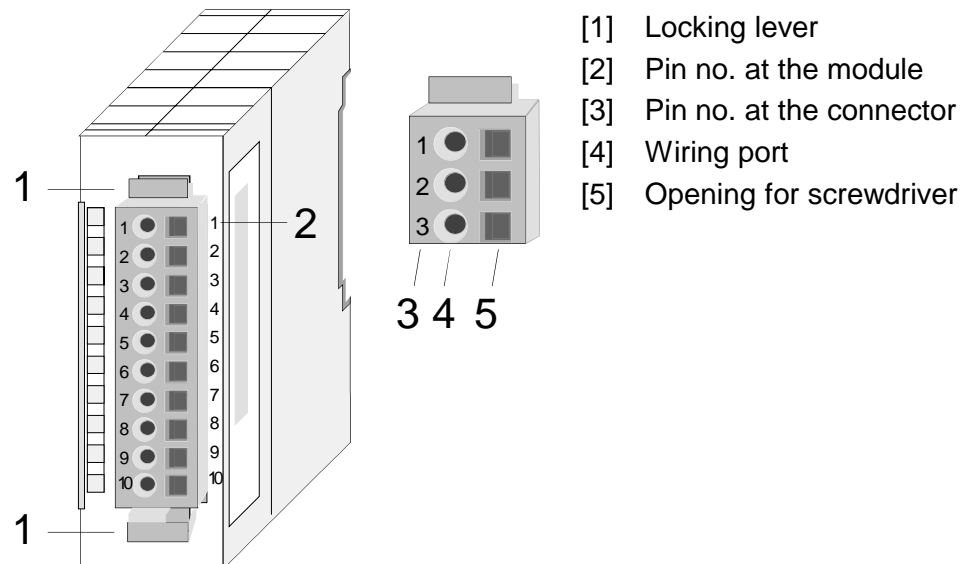

Note!

The spring-clip is destroyed if you push the screwdriver into the wire port! Make sure that you only insert the screwdriver into the square hole of the connector!

Wiring procedure

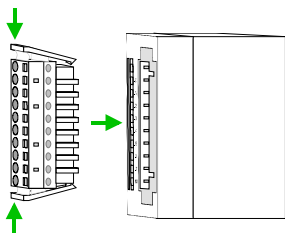

- Install the connector on the module until it locks with an audible click. For this purpose you press the two clips together as shown. The connector is now in a permanent position and can easily be wired.

The following section shows the wiring procedure from top view.

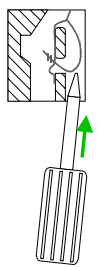

- Insert a screwdriver at an angle into the square opening as shown.
- Press and hold the screwdriver in the opposite direction to open the contact spring.

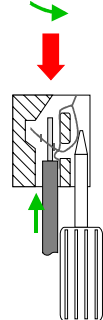

- Insert the stripped end of the wire into the round opening. You can use wires with a diameter of 0.08mm² to 2.5mm² (1.5mm² for 18pole connectors).

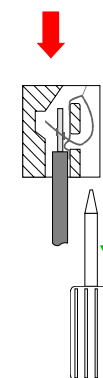

- By removing the screwdriver the wire is connected safely with the plug connector via a spring.



Note!

Wire the power supply connections first followed by the signal cables (inputs and outputs).

Installation guidelines

General The installation guidelines contain information about the interference free deployment of System 200V systems. There is the description of the ways, interference may occur in your control, how you can make sure the electromagnetic digestibility (EMC), and how you manage the isolation.

What means EMC? Electromagnetic digestibility (EMC) means the ability of an electrical device, to function error free in an electromagnetic environment without being interferenced res. without interfering the environment.
All System 200V components are developed for the deployment in hard industrial environments and fulfill high demands on the EMC. Nevertheless you should project an EMC planning before installing the components and take conceivable interference causes into account.

Possible interference causes Electromagnetic interferences may interfere your control via different ways:

- Fields
- I/O signal conductors
- Bus system
- Current supply
- Protected earth conductor

Depending on the spreading medium (lead bound or lead free) and the distance to the interference cause, interferences to your control occur by means of different coupling mechanisms.

One differs:

- galvanic coupling
- capacitive coupling
- inductive coupling
- radiant coupling

Basic rules for EMC

In the most times it is enough to take care of some elementary rules to guarantee the EMC. Please regard the following basic rules when installing your PLC.

- Take care of a correct area-wide grounding of the inactive metal parts when installing your components.
 - Install a central connection between the ground and the protected earth conductor system.
 - Connect all inactive metal extensive and impedance-low.
 - Please try not to use aluminum parts. Aluminum is easily oxidizing and is therefore less suitable for grounding.
- When cabling, take care of the correct line routing.
 - Organize your cabling in line groups (high voltage, current supply, signal and data lines).
 - Always lay your high voltage lines and signal res. data lines in separate channels or bundles.
 - Route the signal and data lines as near as possible beside ground areas (e.g. suspension bars, metal rails, tin cabinet).
- Proof the correct fixing of the lead isolation.
 - Data lines must be laid isolated.
 - Analog lines must be laid isolated. When transmitting signals with small amplitudes the one sided laying of the isolation may be favorable.
 - Lay the line isolation extensively on an isolation/protected earth conductor rail directly after the cabinet entry and fix the isolation with cable clamps.
 - Make sure that the isolation/protected earth conductor rail is connected impedance-low with the cabinet.
 - Use metallic or metalized plug cases for isolated data lines.
- In special use cases you should appoint special EMC actions.
 - Wire all inductivities with erase links.
 - Please consider luminescent lamps can influence signal lines.
- Create a homogeneous reference potential and ground all electrical operating supplies when possible.
 - Please take care for the targeted employment of the grounding actions. The grounding of the PLC is a protection and functionality activity.
 - Connect installation parts and cabinets with the System 200V in star topology with the isolation/protected earth conductor system. So you avoid ground loops.
 - If potential differences between installation parts and cabinets occur, lay sufficiently dimensioned potential compensation lines.

Isolation of conductors

Electrical, magnetically and electromagnetic interference fields are weakened by means of an isolation, one talks of absorption.

Via the isolation rail, that is connected conductive with the rack, interference currents are shunt via cable isolation to the ground. Hereby you have to make sure, that the connection to the protected earth conductor is impedance-low, because otherwise the interference currents may appear as interference cause.

When isolating cables you have to regard the following:

- If possible, use only cables with isolation tangle.
- The hiding power of the isolation should be higher than 80%.
- Normally you should always lay the isolation of cables on both sides. Only by means of the both-sided connection of the isolation you achieve high quality interference suppression in the higher frequency area. Only as exception you may also lay the isolation one-sided. Then you only achieve the absorption of the lower frequencies. A one-sided isolation connection may be convenient, if:
 - the conduction of a potential compensating line is not possible
 - analog signals (some mV res. μA) are transferred
 - foil isolations (static isolations) are used.
- With data lines always use metallic or metalized plugs for serial couplings. Fix the isolation of the data line at the plug rack. Do not lay the isolation on the PIN 1 of the plug bar!
- At stationary operation it is convenient to strip the insulated cable interruption free and lay it on the isolation/protected earth conductor line.
- To fix the isolation tangles use cable clamps out of metal. The clamps must clasp the isolation extensively and have well contact.
- Lay the isolation on an isolation rail directly after the entry of the cable in the cabinet. Lead the isolation further on to the System 200V module and **don't** lay it on there again!

**Please regard at installation!**

At potential differences between the grounding points, there may be a compensation current via the isolation connected at both sides.

Remedy: Potential compensation line.

General data

Structure/ dimensions

- Profile rail 35mm
- Peripheral modules with recessed labelling
- Dimensions of the basic enclosure:
1tier width: (HxWxD) in mm: 76x25.4x74 in inches: 3x1x3
2tier width: (HxWxD) in mm: 76x50.8x74 in inches: 3x2x3

Reliability

- Wiring by means of spring pressure connections (CageClamps) at the front-facing connector, core cross-section 0.08 ... 2.5mm² or 1.5 mm² (18pole plug)
- Complete isolation of the wiring when modules are exchanged
- Every module is isolated from the backplane bus
- ESD/Burst acc. IEC 61000-4-2 / IEC 61000-4-4 (to level 3)
- Shock resistance acc. IEC 60068-2-6 / IEC 60068-2-27 (1G/12G)
- Class of protection IP20

Environmental conditions

- Operating temperature: 0 ... +60°C
- Storage temperature: -25 ... +70°C
- Relative humidity: 5 ... 95% without condensation
- Ventilation by means of a fan is not required

Chapter 2 Hardware description

Overview Here the hardware components of the IM 253-1DN00 are described.
The technical data are at the end of the chapter.

Contents	Topic	Page
	Chapter 2 Hardware description.....	2-1
	Properties.....	2-2
	Structure	2-3
	Technical data.....	2-5

Properties

IM 253DN 253-1DN00

The DeviceNet coupler IM 253DN provides a simple method of interfacing any decentral peripheral modules by means of the DeviceNet protocol.

- Group 2 only Device
 - employs the predefined connection set
- Poll only Device
 - no BIT STROBE mode support
 - no CHANGE OF STATE support
- supports all baudrates: 125, 250 and 500kBaud
- address selection by means of switches
- definition of the data rate by means of a special PowerON procedure (start from address 90 ... 92)
- LED status indicators
- a max. of 32 peripheral modules can be installed
- of these a max. of 8 may be configurable modules
- module configuration by means of the *DeviceNet-Manager*

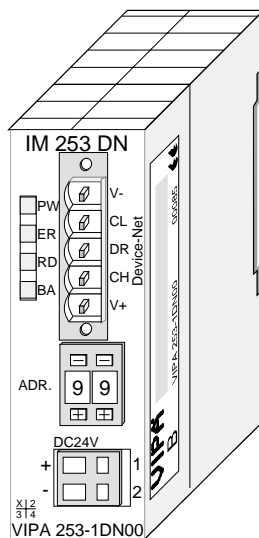

Order data

Type	Order number	Description
IM 253DN	VIPA 253-1DN00	DeviceNet coupler

Structure

Front view
253-1DN00

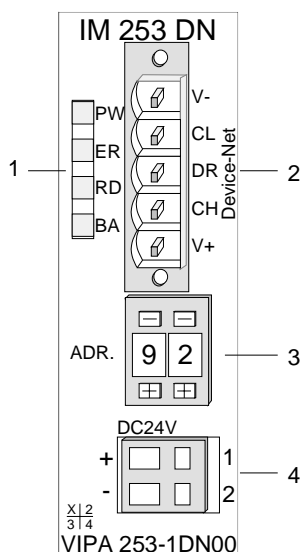

- [1] LED status indicator
- [2] DeviceNet connector
- [3] Address selector
- [4] DC 24V power supply connector

Interfaces

DeviceNet

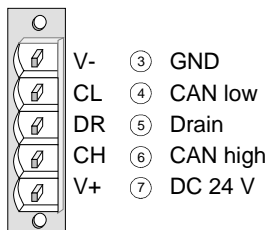

X1

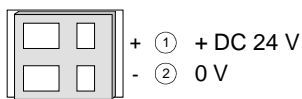

DeviceNet interface

The DeviceNet connection is provided by a 5pin Open Style connector. The pin assignment is imprinted on the front of the module.

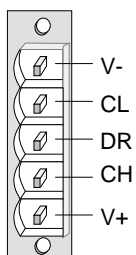

- [V-] GND operating voltage
- [CL] CAN low
- [DR] DRAIN
- [CH] CAN HIGH
- [V+] DC 24V operating voltage

Power supply

Every DeviceNet slave has an internal power supply. This power supply requires DC 24V. In addition to the electronics on the bus coupler, the supply voltage is also used to power any modules connected to the backplane bus. The "max. current drain at backplane bus" can be found in the Technical Data.

The power supply is protected against reverse polarity.
 DeviceNet and backplane bus are galvanically isolated from each other.



Note!

The DeviceNet coupler does not require any current from the power that is available via the DeviceNet connector.

LEDs

4 LEDs on the front show the current status of the module for the quick troubleshooting. A detailed description of the troubleshooting procedure by means of the LEDs and the backplane is available in a section of the chapter "diagnostics".

Label	Color	Description
PW	green	Power-LED: supply voltage available
ER	red	DeviceNet or backplane bus error
RD	green	Backplane bus status
BA	yellow	DeviceNet status

Address selector

The address selector is used for:

- the definition of the unique DeviceNet address
- programming of the baudrate

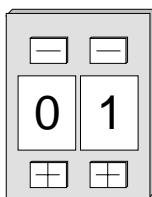

Addresses:

- 0 ... 63: DeviceNet address
- 90: communication rate 125 kBaud
- 91: communication rate 250 kBaud
- 92: communication rate 500kBaud

Technical data

Order number	253-1DN00
Type	IM 253DN, DeviceNET slave
Technical data power supply	
Power supply (rated value)	DC 24 V
Power supply (permitted range)	DC 20.4...28.8 V
Reverse polarity protection	✓
Current consumption (no-load operation)	50 mA
Current consumption (rated value)	800 mA
Inrush current	65 A
I^2t	0.85 A ² s
Max. current drain at backplane bus	3.5 A
Max. current drain load supply	-
Power loss	2 W
Status information, alarms, diagnostics	
Status display	yes
Interrupts	no
Process alarm	no
Diagnostic interrupt	no
Diagnostic functions	yes
Diagnostics information read-out	none
Supply voltage display	yes
Service Indicator	-
Group error display	yes
Channel error display	none
Hardware configuration	
Racks, max.	1
Modules per rack, max.	32
Number of digital modules, max.	32
Number of analog modules, max.	8
Communication	
Fieldbus	DeviceNet
Type of interface	CAN
Connector	5-pin Open Style Connector
Topology	Linear bus with bus termination at both ends
Electrically isolated	✓
Number of participants, max.	64
Node addresses	0 - 63
Transmission speed, min.	125 kbit/s
Transmission speed, max.	500 kbit/s
Address range inputs, max.	256 Byte
Address range outputs, max.	256 Byte
Number of TxPDOs, max.	-
Number of RxPDOs, max.	-
Housing	
Material	PPE / PA 6.6
Mounting	Profile rail 35 mm
Mechanical data	
Dimensions (WxHxD)	25.4 x 76 x 78 mm
Weight	90 g
Environmental conditions	
Operating temperature	0 °C to 60 °C
Storage temperature	-25 °C to 70 °C
Certifications	
UL508 certification	yes

**Additional
Technical Data**

Function specific data	253-1DN00
Network topology	Linear bus, tap lines up to 6m length
Communication medium	Screened 5core cable
Communication rate	125, 250, 500kBaud
Overall length of the bus	up to 500m
Combination with peripheral modules	
Number of modules	max. 32 (of it maximally 8 parameterizable)

Chapter 3 Deployment

Overview

This chapter contains the description of the VIPA DeviceNet slave. Another section of this chapter concerns the configuration by means of the *DeviceNet-Manager* of Allen - Bradley. This section describes the configuration of the DeviceNet coupler and the System 200V modules. A summary of the diagnostic messages conclude the chapter.

Contents

Topic	Page
Chapter 3 Deployment	3-1
Basics DeviceNet	3-2
Configuration by means of the DeviceNet-Manager	3-4
Specifying baudrate and DeviceNet address	3-5
Test in conjunction with the DeviceNet	3-6
Module configuration in the DeviceNet-Manager	3-7
I/O addressing of the DeviceNet scanner	3-12
Diagnostics.....	3-13

Basics DeviceNet

General

DeviceNet is an open low-end network that is based upon the physical properties of CAN-Bus. The bus is also used to supply the devices with the required DC 24V power.

You can use DeviceNet to install direct connections between your control system and simple industrial devices like sensors and switches as well as technologically advanced devices like frequency converters and barcode readers.

Direct interfacing improves communications between the different devices and provides important diagnostic facilities at the device level.

DeviceNet

DeviceNet is an open device net standard that satisfies the user profile for industrial real-time system applications.

The DeviceNet protocol has an open specification that is the property of and administered by the independent vendor organization "Open DeviceNet Vendor Association" ODVA.

This is where standardized device profiles are created to provide compatibility and exchangeability on logical level for simple devices of the same type.

In contrast to the classical source–destination model, DeviceNet uses a modern producer/consumer model that requires data packets with identifier fields for the identification of the data.

This approach caters for multiple priority levels, more efficient transfers of I/O data and multiple consumers for the data.

A device that has data to send *produces* the data on the network together with an identifier. All devices requiring data listen for messages. When a device recognizes a suitable identifier, they act and *consume* the respective data.

DeviceNet carries two types of messages:

- *I/O messages*
Messages that are subject to critical timing constraints and that are contain data for control purposes that can be exchanged by means of a single or multiple connections and that employ identifiers with a high priority.
- *explicit messages*
These are used to establish multi-purpose point-to-point communication paths between two devices which are used for the configuration of network couplers and for diagnostic purposes. These functions usually employ identifiers of a low priority.

Messages that are longer than 8Byte are subject to the fragmentation service. A set of rules for master/slave, peer-to-peer- and multi-master connections is also available.

Communication medium	<p>DeviceNet employs a master line/tap line topology with up to 64 network nodes. The maximum distance is either 500m at a rate of 125kBaud, 250m at a rate of 250kBaud or 100m at a rate of 500kBaud.</p> <p>The length of the tap lines can be up to 6m while the total length of all spur lines depends on the baudrate.</p> <p>Network nodes can be removed from or inserted into the network without interruption of the network operation. New stations and failed stations are detected automatically.</p> <p>DeviceNet employs a screened five-core cable as data communication medium.</p> <p>DeviceNet uses voltage differences and for this reason it exhibits less sensitivity to interference than a voltage or current based interface.</p> <p>Signals and power supply conductors are included in the same network cable. It is therefore possible to connect devices that obtain the operating voltage via the network as well as devices with an integrated power supply. Furthermore it is possible to connect redundant power supplies to the network that guarantees the power supply when required.</p>
Bus access method	<p>DeviceNet operates according to the Carrier-Sense Multiple Access (CSMA) principle, i.e. every station on the network may access the bus when it is not occupied (random access).</p> <p>The exchange of messages is message orientated and not station orientated. Each message is provided with a unique and prioritizing identifier. At any time only one station is able to occupy the bus with its messages.</p> <p>The DeviceNet bus access control is subject to non-destructive, bit-wise arbitration. In this case non-destructive means that the successful station participating in the arbitration doesn't need to re-send its message. The most important station is selected automatically when multiple stations access the bus simultaneously. If a station that is ready to send recognizes that the bus is occupied, its send request is delayed until the current transfer has been completed.</p>
Addressing	<p>All stations on the bus must be uniquely identified by means of an ID address. Every DeviceNet device has addressing facilities.</p>
EDS file	<p>The properties of the DeviceNet units are supplied in the form of an EDS file (Electronic Data Sheet) to configure a slave interface by means of your configuration tool.</p>

Configuration by means of the DeviceNet-Manager

Overview

The DeviceNet is configured by means of the *DeviceNet-Manager* software from Allen - Bradley.

The following steps are necessary for the configuration:

- Configuration of the *DeviceNet-Manager*
- Set baudrate and DeviceNet address of the module
- Test the DeviceNet
- Module configuration
- I/O addressing of the DeviceNet scanner (master)

Configuration of the DeviceNet-Manager

During the configuration the module specific data of the VIPA DeviceNet coupler are defined and supplied to the *DeviceNet-Manager*.

The following steps are required:

- Insert the supplied disc into your PC.
- Copy the file **IM253DN.BMP** to your PC into the directory **/DNETMGR/RES** of the *DeviceNet-Manager*
- The EDS file is located in a sub-directory of 501.VND on the disc. Copy the file **1.EDS** into the directory **/DNETMGR/EDS/501.VND/0.TYP/1.COD**

You can also copy the entire tree

```
501.vnd
  |-- 0.typ
    |--1.cod
      |-- 1.eds
      |-- device.bmp
```

into the directory DNETMGR/EDS.

Specifying baudrate and DeviceNet address

You may set the baudrate as well as the DeviceNet address when the power has been turned off. These will be transferred into the module when you turn the respective power supply on.

Setting the baudrate

All stations connected to the bus communicate at the same baudrate. You may define the required rate by means of the address selector.

- Turn off the power supply
- Set the address selector to the wanted baudrate

Setting	baudrate in kBaud
90	125
91	250
92	500

- Turn on the power supply

The selected transmission rate is saved to the EEPROM.

At this point your DeviceNet coupler is set to the correct baudrate.

LED-indicator
RD-LED
ER-LED

When the baudrate has been saved successfully, the RD-LED (green) will be turned on.

When the baudrate was selected incorrectly, the ER-LED will be turned on.

Setting the DeviceNet address

All stations connected to the bus must have a unique DeviceNet address. The address can be defined by means of the address selector when the supply has been turned off.

- Turn off the power supply
- Set the address selector to the required address.
Please ensure that the address is unique in the system and that it is located between 0 and 63.
- Turn on the power supply.

The selected address is saved to the RAM.



Note!

Any changes to the addressing will only become effective after a PowerON or an automatic reset. Changes to settings are not recognized during normal operations.

LED indicator
ER-LED

When the address is not valid or if it already exists the ER-LED (red) will be turned on after PowerON.

Test in conjunction with the DeviceNet

Approach

- Connect the PC containing the *DeviceNet-Manager* and the VIPA DeviceNet coupler to the DeviceNet.
- Define the baudrate and the node address at the coupler.
- Turn on the power supply of the bus coupler.
- Start the *DeviceNet-Manager*.
- Enter the same data rate into the manager that was selected at the bus coupler.
- Start the function Network Who in the manager.

The following network windows is displayed:

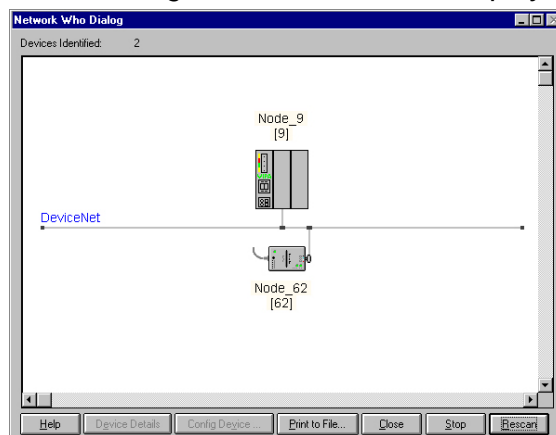

Device Details

- Bus coupler click with the right mouse button.
- Select the function "Device Details" in the context menu.

The Device Details box is displayed on screen:

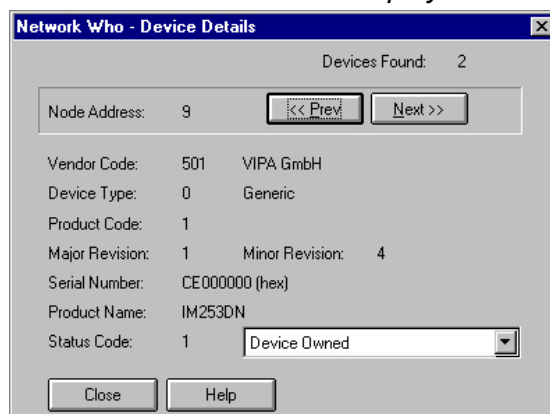

Here you may display DeviceNet address (node address), the Vendor Code (in this case this is 501 for VIPA GmbH) and other internal information about every module on the bus.

Module configuration in the DeviceNet-Manager

The System 200V includes configurable modules like analog modules. When you are using these modules in conjunction with a DeviceNet coupler the respective parameters have to be saved in the DeviceNet coupler.

Configuration in groups

The following conditions apply to the configuration:

- DeviceNet manages the parameter data in groups.
- Every DeviceNet coupler is able to process and store a maximum of 144Byte of parameter data.
- These 144Byte are divided into 8 groups of 18Byte each.
- Every group can contain the parameter data of 1 module.
- Groups are identified by a prefix-No. (1 ... 8) in the parameter name.
- The number of parameter bytes is defined in the parameter "Len" (1. parameter) of a group. The number of parameter bytes is available from the technical data contained in the documentation on the peripheral modules.
- The group allocation for a module does not depend on the location or the installation sequence.
- The allocation of the plug-in location is defined by means of the "Slot"-parameter of a group (2. parameter).
- The values may be entered as bit patterns by double-clicking a parameter.
- Unused groups are identified by a "Value" 0000 0000.

Approach

Precondition: The IM 253DN coupler is active on the bus.

Below follows a description of how the parameter settings are defined in the *DeviceNet-Manager*.

- Execute the function WHO in the *DeviceNet-Manager*.
This will open a network window that includes your coupler.
- Double-click the icon of the bus coupler where you want to modify the parameter data.

Parameter

The parameters are read from the coupler and displayed in the following window:

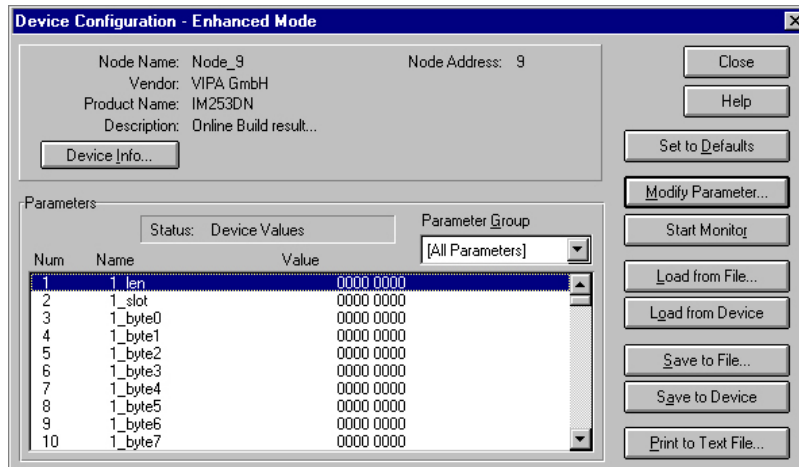

- Locate an unused group in the list of parameters (Value=0000 0000)
You may display all 8 groups in the parameter list by choosing "All Parameters" in the selection field *Parameter Group*.
- Double click the "Len"-parameter

The following dialog box is displayed:

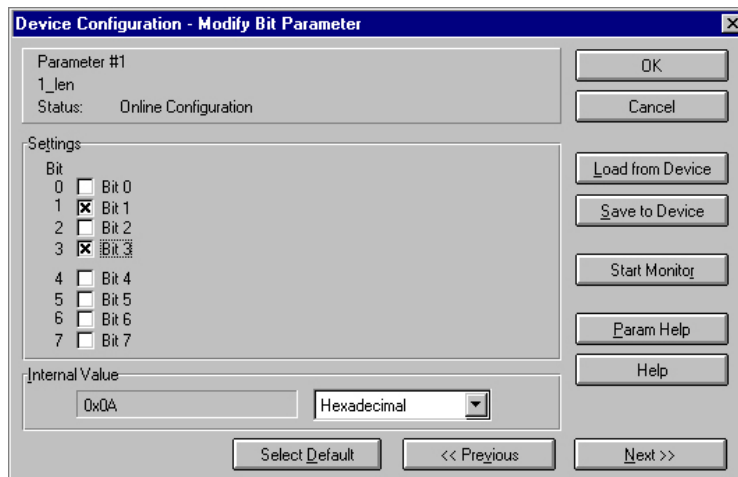

- Enter the number of parameter bytes (bit coded) of the module that you are configuring. You can obtain the number from the documentation for the peripheral module. Set or reset the respective bits by clicking the checkbox.
- Click [OK] to close the mask. The next parameter (slot) of the same group is displayed when you click the button [Next>>].
- Now you have to enter the plug-in location number of the module you are configuring as a bit-code in the same manner.
You can retrieve the input range by means of the button [Param Help].

- At this point you can enter the parameter bytes for your module one after the other by clicking [Next >>].
- If you wish to configure other modules you have to select another unused group and proceed in the same manner.
- When you have entered all parameters into the different groups you transfer and save the parameters in the DeviceNet coupler by clicking the [Save to Device] button.

The following selection window is opened:

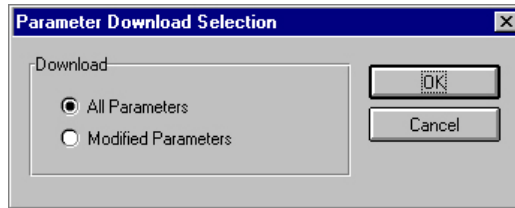

Here you may decide whether you want to transfer all the parameters or only the parameters that were modified.

- During the transfer the status text "Status: downloading" is displayed. When the transfer has completed, the status text changes to "Status: Device Values"
- If you were to request the "Device Details", you may see that the bit CONFIGURED is now also included in the status.

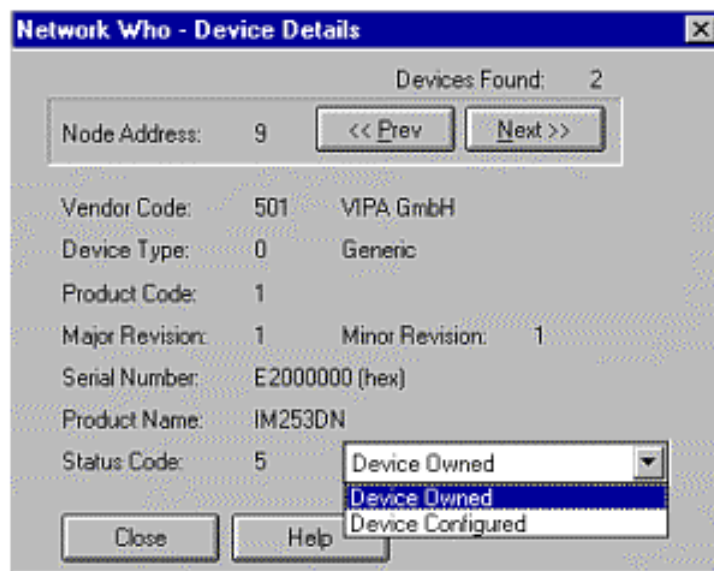

When you have entered the parameter values and downloaded them into the DeviceNet coupler, the peripheral modules connected via the backplane bus have been configured accordingly.

Example

The following example is intended to show the configuration of the System 200V. Let us assume that the system has the following structure:

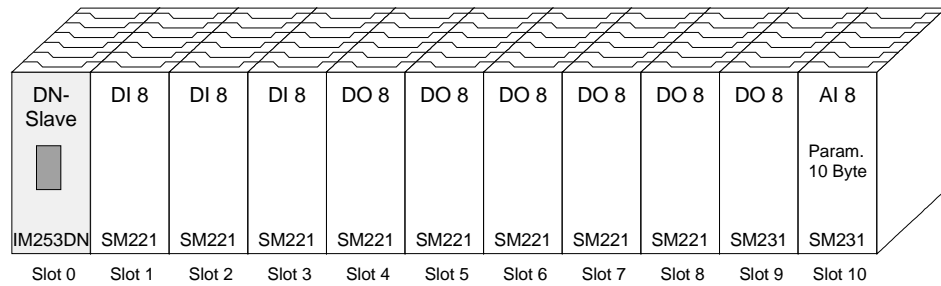

The example shows a DeviceNet coupler with 10 modules; however, the modules installed in plug-in locations 1 to 9 can not be configured. Below follows the description of the configuration of the analog-module in location 10:

Precondition: - the hardware was assembled and is active on the bus.
 - the Allen - Bradley *DeviceNet-Manager* was installed.

- Execute the function WHO in the *DeviceNet-Manager* and open the parameter window by double-clicking the DeviceNet coupler.

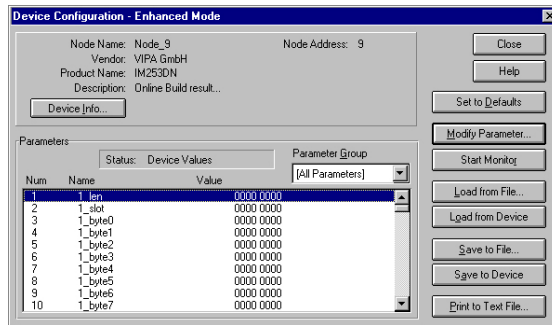

- Locate an unused group in the parameter list (Value=0000 0000)
- Double-click the "_len"-parameter.

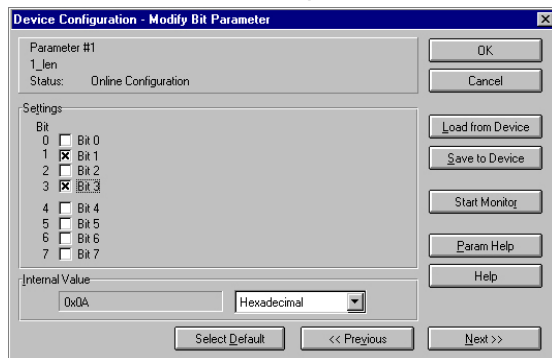

The analog module has 10Byte of parameter data. Enter this value as a bit-coded value.

- Click [Next>>] and enter the location 10 as the "slot".
- You may now enter the parameter bytes of your module by clicking [Next >>] repeatedly.

Parameter

The analog input module has the following parameters:

Byte	Bit 7 ... Bit 0	Default
0	Diagnostic alarm byte: Bit 5 ... 0: reserved Bit 6: 0: Diagnostic alarm inhibited 1: Diagnostic alarm enabled Bit 7: reserved	00h
1	reserved	00h
2	Function no. channel 0 (see module description)	2Dh
3	Function no. channel 1 (see module description)	2Dh
4	Function no. channel 2 (see module description)	2Dh
5	Function no. channel 3 (see module description)	2Dh
6	Option byte channel 0	00h
7	Option byte channel 1	00h
8	Option byte channel 2	00h
9	Option-byte channel 3	00h

- When all parameters have been entered into the group you transfer and save the parameters in the DeviceNet coupler by means of [Save to Device].
- During the transfer the status text is displayed as "Status: downloading". When the transfer has been completed the status text changes to "Status: Device Values".



Note!

Parameters may be changed at any time. For this purpose you have to click [Load from Device], then enter the required changes and save them by means of [Save to Device].

I/O addressing of the DeviceNet scanner

The DeviceNet coupler determines the modules installed on the backplane bus automatically and uses the result to generate the number of input and output bytes.

You have to determine these two values when you configure the input/output modules and enter them in the DeviceNet scanner (master):

- produced connection size (number of input bytes)
- consumed connection size (number of output bytes)

The addressing results from the sequence of the modules (plug-in location 1 ... 32) and the base address that was defined in the DeviceNet scanner for the bus coupler.

DeviceNet scanner configuration

- Set the DeviceNet scanner to connection type POLL IO.
- Define the parameters:
 "Receive data size" = number of input bytes
 "Transmit data size" = number of output bytes
- Define the base address (mapping) of receive data and transmit data as required.
- Activate the DeviceNet coupler IM 253DN in the scan list.
- Start the DeviceNet scanner.

When the DeviceNet scanners have been configured, the input and output modules are accessible via the defined addresses.

Example

The following 6 modules have been installed into the backplane bus:

Plug-in location	Installed modules	Input data	Output data
Slot 0	DeviceNet coupler	-	-
Slot 1	Digital Out SM 222		1Byte
Slot 2	Digital Out SM 222		1Byte
Slot 3	Digital In SM 221	1Byte	
Slot 4	Analog In SM 231	4Words	
Slot 5	Analog Out SM 232		4Words
Total:		1+4*2=9Byte	1+1+4*2=10Byte

The result is:

- produced connection size: 9Byte (sum of input bytes)
- consumed connection size: 10Byte (sum of output bytes)

Diagnostics

Overview

The LEDs installed to display the status allow extensive diagnostics during the PowerON-procedure as well as during operation. The result of the diagnosis is determined by the combination of the different LEDs and the current operating mode.

Explanation:

LED	Description
<input type="checkbox"/> off	LED turned off
<input checked="" type="checkbox"/> on	LED is permanently on
<input checked="" type="checkbox"/> blinks	LED blinks

The following operating modes are available depending on the position of the address selector:

- DeviceNet mode (address selector in position 0 ... 63)
- Configuration mode (address selector in position 90 ... 92)

DeviceNet mode

PowerON without DeviceNet

LED	Description
<input checked="" type="checkbox"/> PW on <input type="checkbox"/> ER off <input checked="" type="checkbox"/> RD blinks <input type="checkbox"/> BA off	After PowerON the PW-LED is turned on and indicates a properly operating power supply. The RD-LED blinks since the configuration data, stored in the EEPROM, was transferred successfully into the peripheral modules.
<input checked="" type="checkbox"/> PW on <input checked="" type="checkbox"/> ER on <input type="checkbox"/> RD off <input type="checkbox"/> BA off	After PowerON the PW-LED is turned on. The ER-LED is on due to errors on the backplane bus or when the configuration data could not be transferred into the peripheral modules.

PowerON with DeviceNet without master

LED	Description
<input checked="" type="checkbox"/> PW on <input type="checkbox"/> ER off <input checked="" type="checkbox"/> RD blinks <input checked="" type="checkbox"/> BA blinks	After PowerON the PW-LED is turned on. The RD-LED blinks because: <ul style="list-style-type: none"> the backplane bus is operating properly the configuration data was transferred successfully from the EEPROM into the configurable peripheral modules. The BA-LED blinks because: <ul style="list-style-type: none"> at least one additional device is active on the DeviceNet, and the address set up on the coupler is unique.
<input checked="" type="checkbox"/> PW on <input checked="" type="checkbox"/> ER on <input type="checkbox"/> RD off <input type="checkbox"/> BA off <input checked="" type="checkbox"/> PW on <input checked="" type="checkbox"/> ER on <input checked="" type="checkbox"/> RD blinks <input checked="" type="checkbox"/> BA blinks	After PowerON the PW-LED is turned on. The ER-LED is on due to one of the following conditions on the DeviceNet coupler: <ul style="list-style-type: none"> bad address or address occupied by another device data transfer rate is bad. After PowerON the PW-LED is on. The ER-LED is turned on when the configuration data could not be transferred into the configurable peripheral module. The RD-LED blinks because <ul style="list-style-type: none"> the backplane bus is operating properly the configuration data was not transferred into the configurable peripheral modules. The BA-LED blinks because <ul style="list-style-type: none"> at least one other device is active on the DeviceNet, the address set up on the coupler is unique.

PowerON with DeviceNet and master

LED	Description
<input checked="" type="checkbox"/> PW on <input checked="" type="checkbox"/> ER on <input checked="" type="checkbox"/> RD blinks <input checked="" type="checkbox"/> BA on	<p>After PowerON the PW-LED is on.</p> <p>The ER-LED is turned on since the configuration data was not transferred into the configurable peripheral modules.</p> <p>The RD-LED blinks because</p> <ul style="list-style-type: none"> the backplane bus operates properly the configuration data was not transferred into the configurable peripheral modules. <p>The BA-LED is turned on</p> <ul style="list-style-type: none"> because the coupler IM 253DN has established a DeviceNet-connection to a master. <p>Note! The IM 253DN coupler executes a reset after 30s. An error that occurs during PowerON with DeviceNet and master displays the same combination of LEDs as a hardware error.</p> <p>It is possible to distinguish between these cases:</p> <ul style="list-style-type: none"> by interruption of the DeviceNet connection → ER-LED and RD are blinking! with a network WHO in the <i>DeviceNet-Manager</i> → in case of a hardware error the IM253DN will not appear on the network. <p>Note! Please call the VIPA hotline if a hardware error occurs!</p>

Proper operation with DeviceNet and master

LED	Description
<input checked="" type="checkbox"/> PW on <input type="checkbox"/> ER off <input checked="" type="checkbox"/> RD on <input checked="" type="checkbox"/> BA on	<p>After PowerON the PW-LED is on. The RD-LED is turned on because the connection to the peripheral modules could be established via the backplane bus.</p> <p>The BA-LED is turned on because the coupler IM 253DN established a DeviceNet connection with a master.</p>

Errors during the operation with DeviceNet and master

LED	Description
<input checked="" type="checkbox"/> PW on	After PowerON the PW-LED is on. The ER-LED is turned on because an error was detected on the backplane bus. The BA-LED is turned on because the IM 253DN coupler established a DeviceNet connection with a master. Note! The IM 253DN coupler will execute a reset after 30s.
<input checked="" type="checkbox"/> ER on	
<input type="checkbox"/> RD off	
<input checked="" type="checkbox"/> BA on	

Change of state from operational to module error status

LED	Description
<input checked="" type="checkbox"/> PW on	The ER-LED is turned on for 1 second because a module error was detected. Subsequently the coupler IM 253DN will execute a reset. After the reset the coupler is re-started and it indicates the error by means of the respective LED combination.
<input checked="" type="checkbox"/> ER on	
<input type="checkbox"/> RD off	
<input type="checkbox"/> BA off	

Indicators after a re-start and a reset

LED	Description
<input checked="" type="checkbox"/> PW on	The ER-LED is turned on permanently and the RD-LED blinks because the quantity of I/O data was changed by the failure of the module. The configuration data could not be transferred. All Allen - Bradley scanners will display message #77.
<input checked="" type="checkbox"/> ER on	
<input checked="" type="checkbox"/> RD blinks	
<input checked="" type="checkbox"/> BA on	
<input checked="" type="checkbox"/> PW on	The ER-LED is not turned on and the RD-LED is permanently on because the quantity of I/O data was modified by the failure of the module. The connection with the I/O modules was established. All Allen - Bradley scanners will display message #77.
<input type="checkbox"/> ER off	
<input checked="" type="checkbox"/> RD on	
<input checked="" type="checkbox"/> BA on	

Change of state from operational to connection error status

LED	Description
<input checked="" type="checkbox"/> PW on	The ER-LED blinks because the timer of the I/O connection detected an error. The RD-LED blinks because the I/O-connection does not exist any longer. All inputs and outputs are set to zero. The BA-LED is turned on because the connection with the master is still established.
<input checked="" type="checkbox"/> ER blinks	
<input checked="" type="checkbox"/> RD blinks	
<input checked="" type="checkbox"/> BA on	

Configuration mode

PowerON in configuration mode

LED	Description
<input checked="" type="checkbox"/> PW on	After PowerON the PW-LED is turned on and indicates that the power supply operates properly. The RD-LED is turned on after a short delay since the baudrate was transferred into the EEPROM.
<input type="checkbox"/> ER off	
<input checked="" type="checkbox"/> RD on	
<input type="checkbox"/> BA off	

Device error

LED	Description
<input checked="" type="checkbox"/> PW on <input checked="" type="checkbox"/> ER on <input type="checkbox"/> RD off <input type="checkbox"/> BA off	The address that was set up on the coupler is not valid. Change the address to a valid setting: <ul style="list-style-type: none"> • 0 ... 63 as DeviceNet address • 90 ... 92 for the definition of the baudrate
<input checked="" type="checkbox"/> PW on <input checked="" type="checkbox"/> ER on <input checked="" type="checkbox"/> RD on <input checked="" type="checkbox"/> BA on	When the coupler is not connected to the DeviceNet, an error was detected in the internal EEPROM or in RAM. When a DeviceNet connection exists, it is also possible that an error has occurred during the transfer of the configuration data into the peripheral modules. <p>Note!</p> Errors that occur during PowerON with DeviceNet and master display the same combination of LEDs as a hardware error. It is possible to distinguish between these cases: <ul style="list-style-type: none"> • by interruption of the DeviceNet connection → ER-LED and RD are blinking! • with a network WHO in the <i>DeviceNet-Manager</i> → in case of a hardware error the IM 253DN will not appear on the network. Please call the VIPA hotline if a hardware error occurs!

