

Makros erzeugen

Seitennavigator: Alle Seiten markieren

> Dienstprogramme

> Makros erzeugen

> Automatisch aus Makroprojekt

Die Makros werden in dem Makroverzeichnis des Benutzers erzeugt.

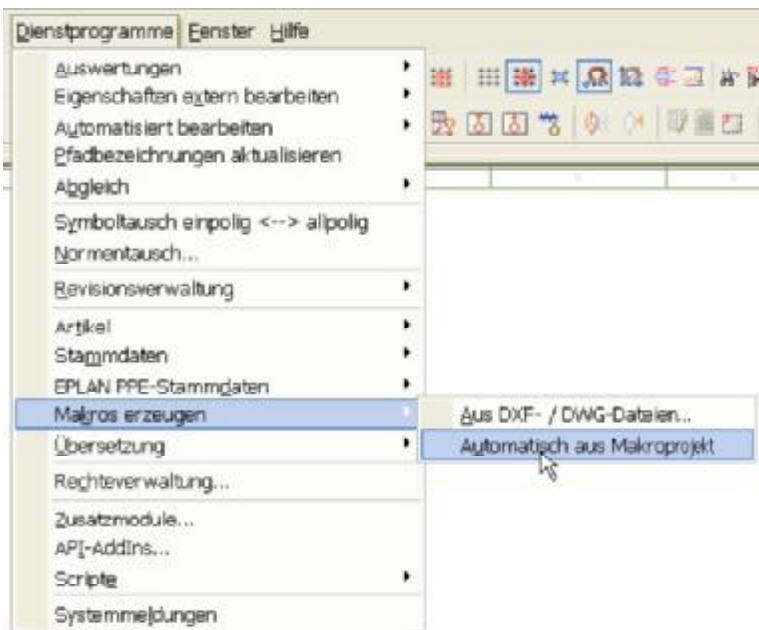

1			Datum	29.11.2010	Produktmakros System 300S
			Bearb.	Winkler	
			Gepr.		
Anderung	Datum	Name	Urspr		Ersatz von



Anleitung Makros erzeugen

			=
			+ DOX
		Blatt	2
		Blatt	387

Artikelstammdaten abgleichen

- > Dienstprogramme
 - > Artikel
 - > Aktuelles Projekt nach Artikeldatenbank

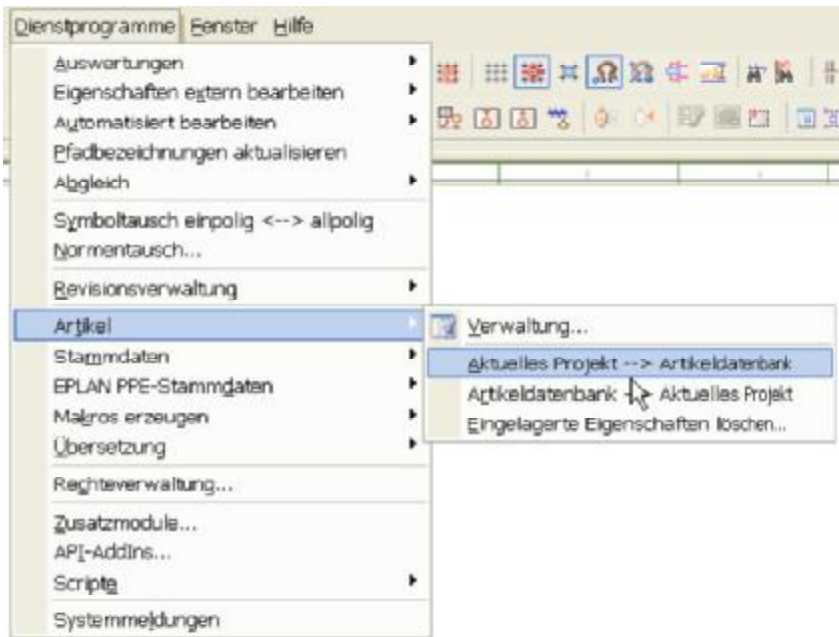

			Datum	29.11.2010	Produktmakros System 300S
			Bearb.	Winkler	
			Gepr.		
Anderung	Datum	Name	Urspr		Ersatz von



		=
		+ DOX
		Blatt 3
		Blatt 387

Bilddateien kopieren

Die Bilddateien aus der Datei VIPA_300S_IMAGES.ZIP in das electric P8 Verzeichnis .. Bilder\VIPA kopieren.

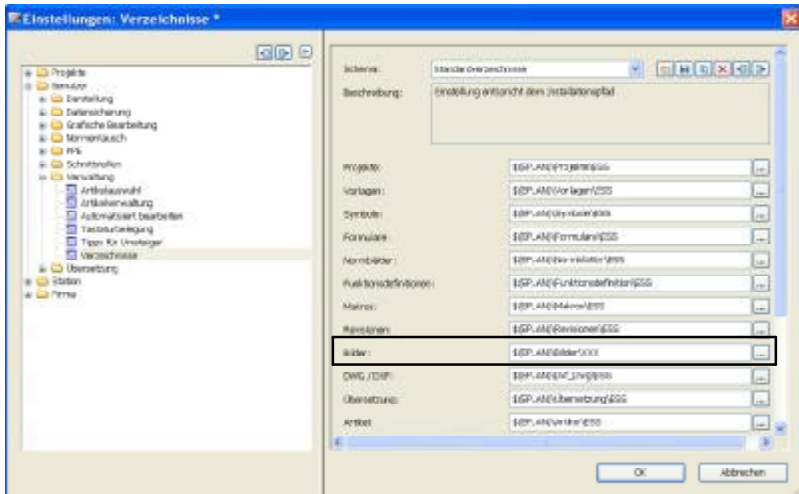

XXX = Kundenspezifisches Installationsverzeichnis

Die Bilder befinden sich dann in dem Verzeichnis ...Bilder\VIPA

		Datum	29.11.2010	Produktmakros System 300S
		Bearb.	Winkler	
		Gepr.		
Anderung	Datum	Name	Urspr	Ersatz von



Bilddateien kopieren

		=
		+ DOK
		Blatt 4
		Blatt 387

Inhaltsverzeichnis

Ort	Seite	Seitenbeschreibung	Datum	Bearbeiter
DOK	1	Deckblatt	29.11.2010	Winkler
DOK	2	Anleitung Makros erzeugen	29.11.2010	Winkler
DOK	3	Artikeldaten synchronisieren	29.11.2010	Winkler
DOK	4	Bilddateien kopieren	29.11.2010	Winkler
DOK	5	Inhaltsverzeichnis	20.12.2016	Winkler
DOK	6	Inhaltsverzeichnis	20.12.2016	Winkler
DOK	7	Inhaltsverzeichnis	20.12.2016	Winkler
DOK	8	Inhaltsverzeichnis	20.12.2016	Winkler
DOK	9	Inhaltsverzeichnis	20.12.2016	Winkler
DOK	10	Inhaltsverzeichnis	20.12.2016	Winkler
DOK	11	Inhaltsverzeichnis	20.12.2016	Winkler
DOK	12	Inhaltsverzeichnis	20.12.2016	Winkler
DOK	13	Inhaltsverzeichnis	20.12.2016	Winkler
DOK	14	Inhaltsverzeichnis	20.12.2016	Winkler
307_1BA00	1	Frontansicht PS 307/2,5A, 307-1BA00	29.11.2010	Winkler
307_1BA00	2	Anschlußbelegung PS 307/2,5A, 307-1BA00	08.05.2014	Winkler
307_1EA00	1	Frontansicht PS 307/5A, 307-1EA00	29.11.2010	Winkler
307_1EA00	2	Anschlußbelegung PS 307/5A, 307-1EA00	08.05.2014	Winkler
307_1FB70	1	Frontansicht PS 307S_Co, 307-1FB70	29.11.2010	Winkler
307_1FB70	2	Anschlußbelegung PS 307S_Co, 307-1FB70	08.05.2014	Winkler
307_1KA00	1	Frontansicht PS 307/10A, 307-1KA00	29.11.2010	Winkler
307_1KA00	2	Anschlußbelegung PS 307/10A, 307-1KA00	08.05.2014	Winkler
312_5BE03	1	SPS-Übersicht CPU 312SC, 312-5BE03	08.05.2014	Winkler
312_5BE03	2	SPS-Übersicht E/A-Bereich CPU 312SC, 312-5BE03	08.05.2014	Winkler
312_5BE03	3	Frontansicht CPU 312SC, 312-5BE03	29.11.2010	Winkler
312_5BE03	4	Anschlußbelegung CPU 312SC, 312-5BE03	08.05.2014	Winkler
312_5BE03	5	Eingangsbyte 0 CPU 312SC, 312-5BE03	08.05.2014	Winkler
312_5BE03	6	Eingangsbyte 1 CPU 312SC, 312-5BE03	08.05.2014	Winkler
312_5BE03	7	Ausgangsbyte 0 CPU 312SC, 312-5BE03	08.05.2014	Winkler
312_5BE13	1	SPS-Übersicht CPU 312SC, 312-5BE13	08.05.2014	Winkler
312_5BE13	2	SPS-Übersicht E/A-Bereich CPU 312SC, 312-5BE13	08.05.2014	Winkler
312_5BE13	3	Frontansicht CPU 312SC, 312-5BE13	29.10.2011	Winkler
312_5BE13	4	Anschlußbelegung CPU 312SC, 312-5BE13	08.05.2014	Winkler
312_5BE13	5	Eingangsbyte 0 CPU 312SC, 312-5BE13	08.05.2014	Winkler
312_5BE13	6	Eingangsbyte 1 CPU 312SC, 312-5BE13	08.05.2014	Winkler
312_5BE13	7	Ausgangsbyte 0 CPU 312SC, 312-5BE13	08.05.2014	Winkler
312_5BE23	1	SPS-Übersicht CPU 312SC, 312-5BE23	19.12.2016	Winkler
312_5BE23	2	SPS-Übersicht E/A-Bereich CPU 312SC, 312-5BE23	19.12.2016	Winkler
312_5BE23	3	Frontansicht CPU 312SC, 312-5BE23	20.12.2016	Winkler

4

6

			Datum	20.12.2016	Produktmakros System 300S		Inhaltsverzeichnis		=	+ DOK	Blatt	5
			Bearb.	Winkler								
			Gepr.									
Änderung	Datum	Name	Urspr		Ersatz von						Blatt	387

Inhaltsverzeichnis

Ort	Seite	Seitenbeschreibung	Datum	Bearbeiter
312_5BE23	4	Anschlußbelegung CPU 312SC, 312-5BE23	19.12.2016	Winkler
312_5BE23	5	Eingangsbyte 0 CPU 312SC, 312-5BE23	19.12.2016	Winkler
312_5BE23	6	Eingangsbyte 1 CPU 312SC, 312-5BE23	19.12.2016	Winkler
312_5BE23	7	Ausgangsbyte 0 CPU 312SC, 312-5BE23	19.12.2016	Winkler
313_5BF03	1	SPS-Übersicht CPU 313SC, 313-5BF03	08.05.2014	Winkler
313_5BF03	2	SPS-Übersicht CPU 313SC, 313-5BF03	08.05.2014	Winkler
313_5BF03	3	SPS-Übersicht E/A-Bereich CPU 313SC, 313-5BF03	08.05.2014	Winkler
313_5BF03	4	Frontansicht CPU 313SC, 313-5BF03	29.11.2010	Winkler
313_5BF03	5	Anschlußbelegung CPU 313SC, 313-5BF03	08.05.2014	Winkler
313_5BF03	6	Analoge Ein-/Ausgänge CPU 313SC, 313-5BF03	08.05.2014	Winkler
313_5BF03	7	Eingangsbyte 2 CPU 313SC, 313-5BF03	08.05.2014	Winkler
313_5BF03	8	Eingangsbyte 0 CPU 313SC, 313-5BF03	08.05.2014	Winkler
313_5BF03	9	Eingangsbyte 1 CPU 313SC, 313-5BF03	08.05.2014	Winkler
313_5BF03	10	Ausgangsbyte 0 CPU 313SC, 313-5BF03	08.05.2014	Winkler
313_5BF03	11	Ausgangsbyte 1 CPU 313SC, 313-5BF03	08.05.2014	Winkler
313_5BF13	1	SPS-Übersicht CPU 313SC, 313-5BF13	08.05.2014	Winkler
313_5BF13	2	SPS-Übersicht CPU 313SC, 313-5BF13	08.05.2014	Winkler
313_5BF13	3	SPS-Übersicht E/A-Bereich CPU 313SC, 313-5BF13	08.05.2014	Winkler
313_5BF13	4	Frontansicht CPU 313SC, 313-5BF13	03.11.2011	Winkler
313_5BF13	5	Anschlußbelegung CPU 313SC, 313-5BF13	08.05.2014	Winkler
313_5BF13	6	Analoge Ein-/Ausgänge CPU 313SC, 313-5BF13	08.05.2014	Winkler
313_5BF13	7	Eingangsbyte 2 CPU 313SC, 313-5BF13	08.05.2014	Winkler
313_5BF13	8	Eingangsbyte 0 CPU 313SC, 313-5BF13	08.05.2014	Winkler
313_5BF13	9	Eingangsbyte 1 CPU 313SC, 313-5BF13	08.05.2014	Winkler
313_5BF13	10	Ausgangsbyte 0 CPU 313SC, 313-5BF13	08.05.2014	Winkler
313_5BF13	11	Ausgangsbyte 1 CPU 313SC, 313-5BF13	08.05.2014	Winkler
313_5BF23	1	SPS-Übersicht CPU 313SC, 313-5BF23	19.12.2016	Winkler
313_5BF23	2	SPS-Übersicht CPU 313SC, 313-5BF23	19.12.2016	Winkler
313_5BF23	3	SPS-Übersicht E/A-Bereich CPU 313SC, 313-5BF23	19.12.2016	Winkler
313_5BF23	4	Frontansicht CPU 313SC, 313-5BF23	20.12.2016	Winkler
313_5BF23	5	Anschlußbelegung CPU 313SC, 313-5BF23	19.12.2016	Winkler
313_5BF23	6	Analoge Ein-/Ausgänge CPU 313SC, 313-5BF23	19.12.2016	Winkler
313_5BF23	7	Eingangsbyte 2 CPU 313SC, 313-5BF23	19.12.2016	Winkler
313_5BF23	8	Eingangsbyte 0 CPU 313SC, 313-5BF23	19.12.2016	Winkler
313_5BF23	9	Eingangsbyte 1 CPU 313SC, 313-5BF23	19.12.2016	Winkler
313_5BF23	10	Ausgangsbyte 0 CPU 313SC, 313-5BF23	19.12.2016	Winkler
313_5BF23	11	Ausgangsbyte 1 CPU 313SC, 313-5BF23	19.12.2016	Winkler
313_6CF03	1	SPS-Übersicht CPU 313SC/DPM, 313-6CF03	08.05.2014	Winkler
313_6CF03	2	SPS-Übersicht E/A-Bereich CPU 313SC/DPM, 313-6CF03	08.05.2014	Winkler

5

7

			Datum	20.12.2016	Produktmakros System 300S		Inhaltsverzeichnis		=	+ DOK	Blatt	6
			Bearb.	Winkler								
			Gepr.									
Änderung	Datum	Name	Urspr.		Ersatz von						Blatt	387

Inhaltsverzeichnis

Ort	Seite	Seitenbeschreibung	Datum	Bearbeiter
313_6CF03	3	Frontansicht CPU 313SC/DPM, 313-6CF03	29.11.2010	Winkler
313_6CF03	4	Anschlußbelegung CPU 313SC/DPM, 313-6CF03	08.05.2014	Winkler
313_6CF03	5	Eingangsbyte 0 CPU 313SC/DPM, 313-6CF03	08.05.2014	Winkler
313_6CF03	6	Eingangsbyte 1 CPU 313SC/DPM, 313-6CF03	08.05.2014	Winkler
313_6CF03	7	Ausgangsbyte 0 CPU 313SC/DPM, 313-6CF03	08.05.2014	Winkler
313_6CF03	8	Ausgangsbyte 1 CPU 313SC/DPM, 313-6CF03	08.05.2014	Winkler
313_6CF13	1	SPS-Übersicht CPU 313SC/DPM, 313-6CF13	08.05.2014	Winkler
313_6CF13	2	SPS-Übersicht E/A-Bereich CPU 313SC/DPM, 313-6CF13	08.05.2014	Winkler
313_6CF13	3	Frontansicht CPU 313SC/DPM, 313-6CF13	29.10.2011	Winkler
313_6CF13	4	Anschlußbelegung CPU 313SC/DPM, 313-6CF13	08.05.2014	Winkler
313_6CF13	5	Eingangsbyte 0 CPU 313SC/DPM, 313-6CF13	08.05.2014	Winkler
313_6CF13	6	Eingangsbyte 1 CPU 313SC/DPM, 313-6CF13	08.05.2014	Winkler
313_6CF13	7	Ausgangsbyte 0 CPU 313SC/DPM, 313-6CF13	08.05.2014	Winkler
313_6CF13	8	Ausgangsbyte 1 CPU 313SC/DPM, 313-6CF13	08.05.2014	Winkler
313_6CF23	1	SPS-Übersicht CPU 313SC/DPM, 313-6CF23	19.12.2016	Winkler
313_6CF23	2	SPS-Übersicht E/A-Bereich CPU 313SC/DPM, 313-6CF23	19.12.2016	Winkler
313_6CF23	3	Frontansicht CPU 313SC/DPM, 313-6CF23	20.12.2016	Winkler
313_6CF23	4	Anschlußbelegung CPU 313SC/DPM, 313-6CF23	19.12.2016	Winkler
313_6CF23	5	Eingangsbyte 0 CPU 313SC/DPM, 313-6CF23	19.12.2016	Winkler
313_6CF23	6	Eingangsbyte 1 CPU 313SC/DPM, 313-6CF23	19.12.2016	Winkler
313_6CF23	7	Ausgangsbyte 0 CPU 313SC/DPM, 313-6CF23	19.12.2016	Winkler
313_6CF23	8	Ausgangsbyte 1 CPU 313SC/DPM, 313-6CF23	19.12.2016	Winkler
314_2AG12	1	SPS-Übersicht CPU 314SB/DPM, 314-2AG12	08.05.2014	Winkler
314_2AG12	2	Frontansicht CPU 314SB/DPM, 314-2AG12	29.10.2011	Winkler
314_2AG12	3	Anschlußbelegung CPU 314SB/DPM, 314-2AG12	08.05.2014	Winkler
314_2AG13	1	SPS-Übersicht CPU 314SB/DPM, 314-2AG13	08.05.2014	Winkler
314_2AG13	2	Frontansicht CPU 314SB/DPM, 314-2AG13	08.05.2014	Winkler
314_2AG13	3	Anschlußbelegung CPU 314SB/DPM, 314-2AG13	08.05.2014	Winkler
314_2AG23	1	SPS-Übersicht CPU 314SB/DPM, 314-2AG23	19.12.2016	Winkler
314_2AG23	2	Frontansicht CPU 314SB/DPM, 314-2AG23	20.12.2016	Winkler
314_2AG23	3	Anschlußbelegung CPU 314SB/DPM, 314-2AG23	19.12.2016	Winkler
314_2BG03	1	SPS-Übersicht CPU 314SE/DPS, 314-2BG03	08.05.2014	Winkler
314_2BG03	2	Frontansicht CPU 314SE/DPS, 314-2BG03	29.11.2010	Winkler
314_2BG03	3	Anschlußbelegung CPU 314SE/DPS, 314-2BG03	08.05.2014	Winkler
314_2BG23	1	SPS-Übersicht CPU 314SE, 314-2BG23	19.12.2016	Winkler
314_2BG23	2	Frontansicht CPU 314SE, 314-2BG23	20.12.2016	Winkler
314_2BG23	3	Anschlußbelegung CPU 314SE, 314-2BG23	19.12.2016	Winkler
314_6CF02	1	SPS-Übersicht CPU 314ST/DPM, 314-6CF02	08.05.2014	Winkler
314_6CF02	2	SPS-Übersicht E/A-Bereich CPU 314ST/DPM, 314-6CF02	08.05.2014	Winkler

6

8

				Datum	20.12.2016	Produktmakros System 300S			Inhaltsverzeichnis		=	
				Bearb.	Winkler						+ DOK	
				Gepr.						Blatt		7
Anderung	Datum	Name	Urspr.			Ersatz von				Blatt		387

Inhaltsverzeichnis

Ort	Seite	Seitenbeschreibung	Datum	Bearbeiter
314_6CF02	3	SPS-Übersicht E/A-Bereich CPU 314ST/DPM, 314-6CF02	08.05.2014	Winkler
314_6CF02	4	Frontansicht CPU 314ST/DPM, 314-6CF02	29.11.2010	Winkler
314_6CF02	5	Anschlußbelegung CPU 314ST/DPM, 314-6CF02	08.05.2014	Winkler
314_6CF02	6	Analoge Ein-/Ausgänge CPU 314ST/DPM, 314-6CF02	08.05.2014	Winkler
314_6CF02	7	Eingangsbyte 0 CPU 314ST/DPM, 314-6CF02	08.05.2014	Winkler
314_6CF02	8	Eingangsbyte 1 CPU 314ST/DPM, 314-6CF02	08.05.2014	Winkler
314_6CF02	9	Ausgangsbyte 0 CPU 314ST/DPM, 314-6CF02	08.05.2014	Winkler
314_6CF03	1	SPS-Übersicht CPU 314ST/DPM, 314-6CF03	08.05.2014	Winkler
314_6CF03	2	SPS-Übersicht E/A-Bereich CPU 314ST/DPM, 314-6CF03	08.05.2014	Winkler
314_6CF03	3	SPS-Übersicht E/A-Bereich CPU 314ST/DPM, 314-6CF03	08.05.2014	Winkler
314_6CF03	4	Frontansicht CPU 314ST/DPM, 314-6CF03	08.05.2014	Winkler
314_6CF03	5	Anschlußbelegung CPU 314ST/DPM, 314-6CF03	08.05.2014	Winkler
314_6CF03	6	Analoge Ein-/Ausgänge CPU 314ST/DPM, 314-6CF03	08.05.2014	Winkler
314_6CF03	7	Eingangsbyte 0 CPU 314ST/DPM, 314-6CF03	08.05.2014	Winkler
314_6CF03	8	Eingangsbyte 1 CPU 314ST/DPM, 314-6CF03	08.05.2014	Winkler
314_6CF03	9	Ausgangsbyte 0 CPU 314ST/DPM, 314-6CF03	08.05.2014	Winkler
314_6CF23	1	SPS-Übersicht CPU 314ST, 314-6CF23	19.12.2016	Winkler
314_6CF23	2	SPS-Übersicht E/A-Bereich CPU 314ST, 314-6CF23	19.12.2016	Winkler
314_6CF23	3	SPS-Übersicht E/A-Bereich CPU 314ST, 314-6CF23	19.12.2016	Winkler
314_6CF23	4	Frontansicht CPU 314ST, 314-6CF23	20.12.2016	Winkler
314_6CF23	5	Anschlußbelegung CPU 314ST, 314-6CF23	19.12.2016	Winkler
314_6CF23	6	Analoge Ein-/Ausgänge CPU 314ST, 314-6CF23	19.12.2016	Winkler
314_6CF23	7	Eingangsbyte 0 CPU 314ST, 314-6CF23	19.12.2016	Winkler
314_6CF23	8	Eingangsbyte 1 CPU 314ST, 314-6CF23	19.12.2016	Winkler
314_6CF23	9	Ausgangsbyte 0 CPU 314ST, 314-6CF23	19.12.2016	Winkler
314_6CG03	1	SPS-Übersicht CPU 314SC/DPM, 314-6CG03	08.05.2014	Winkler
314_6CG03	2	SPS-Übersicht CPU 314SC/DPM, 314-6CG03	08.05.2014	Winkler
314_6CG03	3	SPS-Übersicht CPU 314SC/DPM, 314-6CG03	08.05.2014	Winkler
314_6CG03	4	SPS-Übersicht E/A-Bereich CPU 314SC/DPM, 314-6CG03	08.05.2014	Winkler
314_6CG03	5	Frontansicht CPU 314SC/DPM, 314-6CG03	29.11.2010	Winkler
314_6CG03	6	Anschlußbelegung CPU 314SC/DPM, 314-6CG03	08.05.2014	Winkler
314_6CG03	7	Analoge Ein-/Ausgänge CPU 314SC/DPM, 314-6CG03	08.05.2014	Winkler
314_6CG03	8	Eingangsbyte 2 CPU 314SC/DPM, 314-6CG03	08.05.2014	Winkler
314_6CG03	9	Eingangsbyte 3 CPU 314SC/DPM, 314-6CG03	08.05.2014	Winkler
314_6CG03	10	Ausgangsbyte 2 CPU 314SC/DPM, 314-6CG03	08.05.2014	Winkler
314_6CG03	11	Eingangsbyte 0 CPU 314SC/DPM, 314-6CG03	08.05.2014	Winkler
314_6CG03	12	Eingangsbyte 1 CPU 314SC/DPM, 314-6CG03	08.05.2014	Winkler
314_6CG03	13	Ausgangsbyte 0 CPU 314SC/DPM, 314-6CG03	08.05.2014	Winkler
314_6CG03	14	Ausgangsbyte 1 CPU 314SC/DPM, 314-6CG03	08.05.2014	Winkler

7

9

			Datum	20.12.2016	Produktmakros System 300S		Inhaltsverzeichnis		=	+ DOK	Blatt	8
			Bearb.	Winkler								
			Gepr.									
Änderung	Datum	Name	Urspr.		Ersatz von						Blatt	387

Inhaltsverzeichnis

Ort	Seite	Seitenbeschreibung	Datum	Bearbeiter
314_6CG13	1	SPS-Übersicht CPU 314SC/DPM, 314-6CG13	08.05.2014	Winkler
314_6CG13	2	SPS-Übersicht CPU 314SC/DPM, 314-6CG13	08.05.2014	Winkler
314_6CG13	3	SPS-Übersicht CPU 314SC/DPM, 314-6CG13	08.05.2014	Winkler
314_6CG13	4	SPS-Übersicht E/A-Bereich CPU 314SC/DPM, 314-6CG13	08.05.2014	Winkler
314_6CG13	5	Frontansicht CPU 314SC/DPM, 314-6CG13	29.10.2011	Winkler
314_6CG13	6	Anschlußbelegung CPU 314SC/DPM, 314-6CG13	08.05.2014	Winkler
314_6CG13	7	Analoge Ein-/Ausgänge CPU 314SC/DPM, 314-6CG13	08.05.2014	Winkler
314_6CG13	8	Eingangsbyte 2 CPU 314SC/DPM, 314-6CG13	08.05.2014	Winkler
314_6CG13	9	Eingangsbyte 3 CPU 314SC/DPM, 314-6CG13	08.05.2014	Winkler
314_6CG13	10	Ausgangsbyte 2 CPU 314SC/DPM, 314-6CG13	08.05.2014	Winkler
314_6CG13	11	Eingangsbyte 0 CPU 314SC/DPM, 314-6CG13	08.05.2014	Winkler
314_6CG13	12	Eingangsbyte 1 CPU 314SC/DPM, 314-6CG13	08.05.2014	Winkler
314_6CG13	13	Ausgangsbyte 0 CPU 314SC/DPM, 314-6CG13	08.05.2014	Winkler
314_6CG13	14	Ausgangsbyte 1 CPU 314SC/DPM, 314-6CG13	08.05.2014	Winkler
314_6CG23	1	SPS-Übersicht CPU 314SC/DPM, 314-6CG23	19.12.2016	Winkler
314_6CG23	2	SPS-Übersicht CPU 314SC/DPM, 314-6CG23	19.12.2016	Winkler
314_6CG23	3	SPS-Übersicht CPU 314SC/DPM, 314-6CG23	19.12.2016	Winkler
314_6CG23	4	SPS-Übersicht E/A-Bereich CPU 314SC/DPM, 314-6CG23	19.12.2016	Winkler
314_6CG23	5	Frontansicht CPU 314SC/DPM, 314-6CG23	20.12.2016	Winkler
314_6CG23	6	Anschlußbelegung CPU 314SC/DPM, 314-6CG23	19.12.2016	Winkler
314_6CG23	7	Analoge Ein-/Ausgänge CPU 314SC/DPM, 314-6CG23	19.12.2016	Winkler
314_6CG23	8	Eingangsbyte 2 CPU 314SC/DPM, 314-6CG23	19.12.2016	Winkler
314_6CG23	9	Eingangsbyte 3 CPU 314SC/DPM, 314-6CG23	19.12.2016	Winkler
314_6CG23	10	Ausgangsbyte 2 CPU 314SC/DPM, 314-6CG23	19.12.2016	Winkler
314_6CG23	11	Eingangsbyte 0 CPU 314SC/DPM, 314-6CG23	19.12.2016	Winkler
314_6CG23	12	Eingangsbyte 1 CPU 314SC/DPM, 314-6CG23	19.12.2016	Winkler
314_6CG23	13	Ausgangsbyte 0 CPU 314SC/DPM, 314-6CG23	19.12.2016	Winkler
314_6CG23	14	Ausgangsbyte 1 CPU 314SC/DPM, 314-6CG23	19.12.2016	Winkler
315_2AG12	1	SPS-Übersicht CPU 315SB/DPM, 315-2AG12	08.05.2014	Winkler
315_2AG12	2	Frontansicht CPU 315SB/DPM, 315-2AG12	29.11.2010	Winkler
315_2AG12	3	Anschlußbelegung CPU 315SB/DPM, 315-2AG12	08.05.2014	Winkler
315_2AG13	1	SPS-Übersicht CPU 315SB/DPM, 315-2AG13	08.05.2014	Winkler
315_2AG13	2	Frontansicht CPU 315SB/DPM, 315-2AG13	08.05.2014	Winkler
315_2AG13	3	Anschlußbelegung CPU 315SB/DPM, 315-2AG13	08.05.2014	Winkler
315_2AG23	1	SPS-Übersicht CPU 315SB, 315-2AG23	19.12.2016	Winkler
315_2AG23	2	Frontansicht CPU 315SB, 315-2AG23	20.12.2016	Winkler
315_2AG23	3	Anschlußbelegung CPU 315SB, 315-2AG23	19.12.2016	Winkler
315_4EC12	1	SPS-Übersicht CPU 315SN/EC, 315-4EC12	08.05.2014	Winkler
315_4EC12	2	Frontansicht CPU 315SN/EC, 315-4EC12	08.05.2014	Winkler

8

10

		Datum 20.12.2016		Produktmakros System 300S		Inhaltsverzeichnis			=	
		Bearb. Winkler							+ DOK	
Änderung		Datum	Name	Urspr	Ersatz von					Blatt 9
										Blatt 387

Inhaltsverzeichnis

Ort	Seite	Seitenbeschreibung	Datum	Bearbeiter
315_4EC12	3	Anschlußbelegung CPU 315SN/EC, 315-4EC12	08.05.2014	Winkler
315_4EC32	1	SPS-Übersicht CPU 315SN/EC, 315-4EC32	12.05.2014	Winkler
315_4EC32	2	Frontansicht CPU 315SN/EC, 315-4EC32	08.05.2014	Winkler
315_4EC32	3	Anschlußbelegung CPU 315SN/EC, 315-4EC32	12.05.2014	Winkler
315_4NE12	1	SPS-Übersicht CPU 315SN/NET, 315-4NE12	08.05.2014	Winkler
315_4NE12	2	Frontansicht CPU 315SN/NET, 315-4NE12	29.11.2010	Winkler
315_4NE12	3	Anschlußbelegung CPU 315SN/NET, 315-4NE12	08.05.2014	Winkler
315_4NE13	1	SPS-Übersicht CPU 315SN/NET, 315-4NE13	08.05.2014	Winkler
315_4NE13	2	Frontansicht CPU 315SN/NET, 315-4NE13	08.05.2014	Winkler
315_4NE13	3	Anschlußbelegung CPU 315SN/NET, 315-4NE13	08.05.2014	Winkler
315_4NE23	1	SPS-Übersicht CPU 315SN, 315-4NE23	19.12.2016	Winkler
315_4NE23	2	Frontansicht CPU 315SN, 315-4NE23	20.12.2016	Winkler
315_4NE23	3	Anschlußbelegung CPU 315SN, 315-4NE23	19.12.2016	Winkler
315_4PN12	1	SPS-Übersicht CPU 315SN/PN, 315-4PN12	08.05.2014	Winkler
315_4PN12	2	Frontansicht CPU 315SN/PN, 315-4PN12	29.10.2011	Winkler
315_4PN12	3	Anschlußbelegung CPU 315SN/PN, 315-4PN12	08.05.2014	Winkler
315_4PN23	1	SPS-Übersicht CPU 315PN ECO, 315-4PN23	19.12.2016	Winkler
315_4PN23	2	Frontansicht CPU 315PN ECO, 315-4PN23	19.12.2016	Winkler
315_4PN23	3	Anschlußbelegung CPU 315PN ECO, 315-4PN23	19.12.2016	Winkler
315_4PN33	1	SPS-Übersicht CPU 315SN/PN ECO, 315-4PN33	08.05.2014	Winkler
315_4PN33	2	Frontansicht CPU 315SN/PN ECO, 315-4PN33	08.05.2014	Winkler
315_4PN33	3	Anschlußbelegung CPU 315SN/PN ECO, 315-4PN33	08.05.2014	Winkler
315_4PN43	1	SPS-Übersicht CPU 315PN ECO, 315-4PN43	19.12.2016	Winkler
315_4PN43	2	Frontansicht CPU 315PN ECO, 315-4PN43	19.12.2016	Winkler
315_4PN43	3	Anschlußbelegung CPU 315PN ECO, 315-4PN43	19.12.2016	Winkler
317_2AJ12	1	SPS-Übersicht CPU 317SE/DPM, 317-2AJ12	08.05.2014	Winkler
317_2AJ12	2	Frontansicht CPU 317SE/DPM, 317-2AJ12	29.11.2010	Winkler
317_2AJ12	3	Anschlußbelegung CPU 317SE/DPM, 317-2AJ12	08.05.2014	Winkler
317_2AJ23	1	SPS-Übersicht CPU 317SE, 317-2AJ23	19.12.2016	Winkler
317_2AJ23	2	Frontansicht CPU 317SE, 317-2AJ23	20.12.2016	Winkler
317_2AJ23	3	Anschlußbelegung CPU 317SE, 317-2AJ23	19.12.2016	Winkler
317_4EC12	1	SPS-Übersicht CPU 317SN/EC, 317-4EC12	08.05.2014	Winkler
317_4EC12	2	Frontansicht CPU 317SN/EC, 317-4EC12	08.05.2014	Winkler
317_4EC12	3	Anschlußbelegung CPU 317SN/EC, 317-4EC12	08.05.2014	Winkler
317_4NE12	1	SPS-Übersicht CPU 317SN/NET, 317-4NE12	08.05.2014	Winkler
317_4NE12	2	Frontansicht CPU 317SN/NET, 317-4NE12	29.11.2010	Winkler
317_4NE12	3	Anschlußbelegung CPU 317SN/NET, 317-4NE12	08.05.2014	Winkler
317_4NE13	1	SPS-Übersicht CPU 317SN/NET, 317-4NE13	08.05.2014	Winkler
317_4NE13	2	Frontansicht CPU 317SN/NET, 317-4NE13	08.05.2014	Winkler

		Datum	20.12.2016	Produktmakros System 300S		Inhaltsverzeichnis			=
		Bearb.	Winkler						+ DOK
		Gepr.							
Änderung	Datum	Name	Urspr	Ersatz von					
									Blatt 10
									Blatt 387

Inhaltsverzeichnis

Ort	Seite	Seitenbeschreibung	Datum	Bearbeiter
317_4NE13	3	Anschlußbelegung CPU 317SN/NET, 317-4NE13	08.05.2014	Winkler
317_4NE23	1	SPS-Übersicht CPU 317SN, 317-4NE23	19.12.2016	Winkler
317_4NE23	2	Frontansicht CPU 317SN, 317-4NE23	20.12.2016	Winkler
317_4NE23	3	Anschlußbelegung CPU 317SN, 317-4NE23	19.12.2016	Winkler
317_4PN12	1	SPS-Übersicht CPU 317SN/PN, 317-4PN12	08.05.2014	Winkler
317_4PN12	2	Frontansicht CPU 317SN/PN, 317-4PN12	29.10.2011	Winkler
317_4PN12	3	Anschlußbelegung CPU 317SN/PN, 317-4PN12	08.05.2014	Winkler
317_4PN23	1	SPS-Übersicht CPU 317PN, 317-4PN23	19.12.2016	Winkler
317_4PN23	2	Frontansicht CPU 317PN, 317-4PN23	20.12.2016	Winkler
317_4PN23	3	Anschlußbelegung CPU 317PN, 317-4PN23	19.12.2016	Winkler
321_1BH01	1	SPS-Übersicht SM 321 DI 16xDC24V 321-1BH01	08.05.2014	Winkler
321_1BH01	2	Frontansicht SM 321 DI 16xDC24V 321-1BH01	30.11.2010	Winkler
321_1BH01	3	Eingangsbyte 0 SM 321 DI 16xDC24V 321-1BH01	08.05.2014	Winkler
321_1BH01	4	Eingangsbyte 1 SM 321 DI 16xDC24V 321-1BH01	08.05.2014	Winkler
321_1BH70	1	SPS-Übersicht SM 321S DI 16xDC 24V, 321-1BH70	08.05.2014	Winkler
321_1BH70	2	Frontansicht SM 321S DI 16xDC 24V, 321-1BH70	30.11.2010	Winkler
321_1BH70	3	Eingangsbyte 0 SM 321S DI 16xDC 24V, 321-1BH70	08.05.2014	Winkler
321_1BH70	4	Eingangsbyte 1 SM 321S DI 16xDC 24V, 321-1BH70	08.05.2014	Winkler
321_1BL00	1	SPS-Übersicht SM 321 DI 32xDC24V 321-1BL00	08.05.2014	Winkler
321_1BL00	2	Frontansicht SM 321 DI 32xDC24V 321-1BL00	30.11.2010	Winkler
321_1BL00	3	Eingangsbyte 0 SM 321 DI 16xDC24V 321-1BL00	08.05.2014	Winkler
321_1BL00	4	Eingangsbyte 1 SM 321 DI 16xDC24V 321-1BL00	08.05.2014	Winkler
321_1BL00	5	Eingangsbyte 2 SM 321 DI 16xDC24V 321-1BL00	08.05.2014	Winkler
321_1BL00	6	Eingangsbyte 3 SM 321 DI 16xDC24V 321-1BL00	08.05.2014	Winkler
321_1FH00	1	SPS-Übersicht SM 321 DI 16xAC120/230V 321-1FH00	08.05.2014	Winkler
321_1FH00	2	Frontansicht SM 321 DI 16xAC120/230V 321-1FH00	30.11.2010	Winkler
321_1FH00	3	Eingangsbyte 0 SM 321 DI 16xAC120/230V 321-1FH00	08.05.2014	Winkler
321_1FH00	4	Eingangsbyte 1 SM 321 DI 16xAC120/230V 321-1FH00	08.05.2014	Winkler
322_1BF01	1	SPS-Übersicht 322 8xDO DC24V/2A 322-1BF01	08.05.2014	Winkler
322_1BF01	2	Frontansicht 322 8xDO DC24V/2A 322-1BF01	30.11.2010	Winkler
322_1BF01	3	Ausgangsbyte 0 322 8xDO DC24V/2A 322-1BF01	08.05.2014	Winkler
322_1BF01	4	Ausgangsbyte 0 322 8xDO DC24V/2A 322-1BF01	08.05.2014	Winkler
322_1BH01	1	SPS-Übersicht 322 16xDO DC24V/1A 322-1BH01	08.05.2014	Winkler
322_1BH01	2	Frontansicht 322 16xDO DC24V/1A 322-1BH01	30.11.2010	Winkler
322_1BH01	3	Ausgangsbyte 0 322 16xDO DC24V/1A 322-1BH01	08.05.2014	Winkler
322_1BH01	4	Ausgangsbyte 1 322 16xDO DC24V/1A 322-1BH01	08.05.2014	Winkler
322_1BH41	1	SPS-Übersicht 322 16xDO DC24V/2A 322-1BH41	08.05.2014	Winkler
322_1BH41	2	Frontansicht 322 16xDO DC24V/2A 322-1BH41	30.11.2010	Winkler
322_1BH41	3	Ausgangsbyte 0 322 16xDO DC24V/2A 322-1BH41	08.05.2014	Winkler

Inhaltsverzeichnis

Ort	Seite	Seitenbeschreibung	Datum	Bearbeiter
322_1BH41	4	Ausgangsbyte 1 322 16xDC DC24V/2A 322-1BH41	08.05.2014	Winkler
322_1BH60	1	SPS-Übersicht 322 16xDC DC24V/0,5A 322-1BH60	08.05.2014	Winkler
322_1BH60	2	Frontansicht 322 16xDC DC24V/0,5A 322-1BH60	30.11.2010	Winkler
322_1BH60	3	Ausgangsbyte 0 322 16xDC DC24V/0,5A 322-1BH60	08.05.2014	Winkler
322_1BH60	4	Ausgangsbyte 1 322 16xDC DC24V/0,5A 322-1BH60	08.05.2014	Winkler
322_1BH70	1	SPS-Übersicht SM 322S DO 16xDC 24V 0,5A, 322-1BH70	08.05.2014	Winkler
322_1BH70	2	Frontansicht SM 322S DO 16xDC 24V 0,5A, 322-1BH70	30.11.2010	Winkler
322_1BH70	3	Ausgangsbyte 0 SM 322S DO 16xDC 24V 0,5A, 322-1BH70	08.05.2014	Winkler
322_1BH70	4	Ausgangsbyte 1 SM 322S DO 16xDC 24V 0,5A, 322-1BH70	08.05.2014	Winkler
322_1BL00	1	SPS-Übersicht 322 32xDC DC24V/1A 322-1BL00	08.05.2014	Winkler
322_1BL00	2	Frontansicht 322 32xDC DC24V/1A 322-1BL00	30.11.2010	Winkler
322_1BL00	3	Ausgangsbyte 0 322 32xDC DC24V/1A 322-1BL00	08.05.2014	Winkler
322_1BL00	4	Ausgangsbyte 1 322 32xDC DC24V/1A 322-1BL00	08.05.2014	Winkler
322_1BL00	5	Ausgangsbyte 2 322 32xDC DC24V/1A 322-1BL00	08.05.2014	Winkler
322_1BL00	6	Ausgangsbyte 3 322 32xDC DC24V/1A 322-1BL00	08.05.2014	Winkler
322_1HH00	1	SPS-Übersicht 322 16xDC RELAIS 322-1HH00	08.05.2014	Winkler
322_1HH00	2	Frontansicht 322 16xDC RELAIS 322-1HH00	30.11.2010	Winkler
322_1HH00	3	Ausgangsbyte 0 322 16xDC RELAIS 322-1HH00	08.05.2014	Winkler
322_1HH00	4	Ausgangsbyte 1 322 16xDC RELAIS 322-1HH00	08.05.2014	Winkler
322_5FF00	1	SPS-Übersicht 322 8xDC AC120/230V/2A 322-5FF00	08.05.2014	Winkler
322_5FF00	2	Frontansicht 322 8xDC AC120/230V/2A 322-5FF00	30.11.2010	Winkler
322_5FF00	3	Ausgangsbyte 0 322 8xDC AC120/230V/2A 322-5FF00	08.05.2014	Winkler
322_5FF00	4	Ausgangsbyte 0 322 8xDC AC120/230V/2A 322-5FF00	08.05.2014	Winkler
323_1BH00	1	SPS-Übersicht 323 16xDIO DC24V/1A 323-1BH00	08.05.2014	Winkler
323_1BH00	2	Frontansicht 323 16xDIO DC24V/1A 323-1BH00	30.11.2010	Winkler
323_1BH00	3	Eingangsbyte 0 323 16xDIO DC24V/1A 323-1BH00	08.05.2014	Winkler
323_1BH00	4	Eingangsbyte 1 323 16xDIO DC24V/1A 323-1BH00	08.05.2014	Winkler
323_1BH00	5	Ausgangsbyte 0 323 16xDIO DC24V/1A 323-1BH00	08.05.2014	Winkler
323_1BH00	6	Ausgangsbyte 1 323 16xDIO DC24V/1A 323-1BH00	08.05.2014	Winkler
323_1BH01	1	SPS-Übersicht SM 323 8xDI, 8xDC DC24V 323-1BH01	08.05.2014	Winkler
323_1BH01	2	Frontansicht SM 323 8xDI, 8xDC DC24V 323-1BH01	30.11.2010	Winkler
323_1BH01	3	Eingangsbyte 0 SM 323 8xDI, 8xDC DC24V 323-1BH01	08.05.2014	Winkler
323_1BH01	4	Ausgangsbyte 0 SM 323 8xDI, 8xDC DC24V 323-1BH01	08.05.2014	Winkler
323_1BH70	1	SPS-Übersicht SM 323S DIO 16xDC 24V 0,5A, 323-1BH70	08.05.2014	Winkler
323_1BH70	2	Frontansicht SM 323S DIO 16xDC 24V 0,5A, 323-1BH70	30.11.2010	Winkler
323_1BH70	3	Eingangsbyte 0 SM 323S DIO 16xDC 24V 0,5A, 323-1BH70	08.05.2014	Winkler
323_1BH70	4	Eingangsbyte 1 SM 323S DIO 16xDC 24V 0,5A, 323-1BH70	08.05.2014	Winkler
323_1BH70	5	Ausgangsbyte 0 SM 323S DIO 16xDC 24V 0,5A, 323-1BH70	08.05.2014	Winkler
323_1BH70	6	Ausgangsbyte 1 SM 323S DIO 16xDC 24V 0,5A, 323-1BH70	08.05.2014	Winkler

			Datum	20.12.2016	Produktmakros System 300S		Inhaltsverzeichnis		=	+ DOK	Blatt 12
			Bearb.	Winkler							
			Gepr.								
Änderung	Datum	Name	Urspr		Ersatz von						Blatt 387

Inhaltsverzeichnis

Ort	Seite	Seitenbeschreibung	Datum	Bearbeiter
323_1BL00	1	SPS-Übersicht SM 323 16xDI, 16xDO DC24V 323-1BL00	08.05.2014	Winkler
323_1BL00	2	Frontansicht SM 323 16xDI, 16xDO DC24V 323-1BL00	30.11.2010	Winkler
323_1BL00	3	Eingangsbyte 0 SM 323 16xDI, 16xDO DC24V 323-1BL00	08.05.2014	Winkler
323_1BL00	4	Eingangsbyte 1 SM 323 16xDI, 16xDO DC24V 323-1BL00	08.05.2014	Winkler
323_1BL00	5	Ausgangsbyte 0 SM 323 16xDI, 16xDO DC24V 323-1BL00	08.05.2014	Winkler
323_1BL00	6	Ausgangsbyte 1 SM 323 16xDI, 16xDO DC24V 323-1BL00	08.05.2014	Winkler
331_1KF01	1	SPS-Übersicht SM 331 AI 8x13 Bit 331-1KF01	08.05.2014	Winkler
331_1KF01	2	Frontansicht SM 331 AI 8x13 Bit 331-1KF01	30.11.2010	Winkler
331_1KF01	3	Eingangskanal 0-3 SM 331 AI 8x13 Bit 331-1KF01	08.05.2014	Winkler
331_1KF01	4	Eingangskanal 4-7 SM 331 AI 8x13 Bit 331-1KF01	08.05.2014	Winkler
331_7AF70	1	SPS-Übersicht SM 331 AI 8x16 Bit 331-7AF70	08.05.2014	Winkler
331_7AF70	2	Frontansicht SM 331 AI 8x16 Bit 331-7AF70	30.11.2010	Winkler
331_7AF70	3	Eingangskanal 0-3 SM 331 AI 8x16 Bit 331-7AF70	08.05.2014	Winkler
331_7AF70	4	Eingangskanal 4-7 SM 331 AI 8x16 Bit 331-7AF70	08.05.2014	Winkler
331_7BF70	1	SPS-Übersicht SM 331 AI 8x16 Bit 331-7BF70	08.05.2014	Winkler
331_7BF70	2	Frontansicht SM 331 AI 8x16 Bit 331-7BF70	30.11.2010	Winkler
331_7BF70	3	Eingangskanal 0-3 SM 331 AI 8x16 Bit 331-7BF70	08.05.2014	Winkler
331_7BF70	4	Eingangskanal 4-7 SM 331 AI 8x16 Bit 331-7BF70	08.05.2014	Winkler
331_7KB01	1	SPS-Übersicht SM 331 AI 2x12 Bit 331-7KB01	08.05.2014	Winkler
331_7KB01	2	Frontansicht SM 331 AI 2x12 Bit 331-7KB01	30.11.2010	Winkler
331_7KB01	3	Eingangskanal 0/1 SM 331 AI 2x12 Bit 331-7KB01	08.05.2014	Winkler
331_7KF01	1	SPS-Übersicht SM 331 AI 8x12 Bit 331-7KF01	08.05.2014	Winkler
331_7KF01	2	Frontansicht SM 331 AI 8x12 Bit 331-7KF01	30.11.2010	Winkler
331_7KF01	3	Eingangskanal 0-3 SM 331 AI 8x12Bit 331-7KF01	08.05.2014	Winkler
331_7KF01	4	Eingangskanal 4-7 SM 331 AI 8x12Bit 331-7KF01	08.05.2014	Winkler
332_5HB01	1	SPS-Übersicht SM 332 AO 2x12 Bit 332-5HB01	08.05.2014	Winkler
332_5HB01	2	Frontansicht SM 332 AO 2x12 Bit 332-5HB01	30.11.2010	Winkler
332_5HB01	3	Ausgangskanal 0/1 SM 332 AO 2x12 Bit 332-5HB01	08.05.2014	Winkler
332_5HD01	1	SPS-Übersicht SM 332 AO 4x12Bit 332-5HD01	08.05.2014	Winkler
332_5HD01	2	Frontansicht SM 332 AO 4x12Bit 332-5HD01	30.11.2010	Winkler
332_5HD01	3	Ausgangskanal 0/1 SM 332 AO 4x12Bit 332-5HD01	08.05.2014	Winkler
332_5HD01	4	Ausgangskanal 2/3 SM 332 AO 4x12Bit 332-5HD01	08.05.2014	Winkler
332_5HD50	1	SPS-Übersicht SM 332 AO 4x12Bit I 332-5HD50	08.05.2014	Winkler
332_5HD50	2	Frontansicht SM 332 AO 4x12Bit I 332-5HD50	30.11.2010	Winkler
332_5HD50	3	Ausgangskanal 0/1 SM 332 AO 4x12Bit I 332-5HD50	08.05.2014	Winkler
332_5HD50	4	Ausgangskanal 2/3 SM 332 AO 4x12Bit I 332-5HD50	08.05.2014	Winkler
332_5HD60	1	SPS-Übersicht SM 332 AO 4x12Bit U 332-5HD60	08.05.2014	Winkler
332_5HD60	2	Frontansicht SM 332 AO 4x12Bit U 332-5HD60	30.11.2010	Winkler
332_5HD60	3	Ausgangskanal 0/1 SM 332 AO 4x12Bit U 332-5HD60	08.05.2014	Winkler

Inhaltsverzeichnis

Ort	Seite	Seitenbeschreibung	Datum	Bearbeiter
332_5HD60	4	Ausgangskanal 2/3 SM 332 AO 4x12Bit U 332-5HD60	08.05.2014	Winkler
334_OKE00	1	SPS-Übersicht SM 334 AI 4/AO 2x12Bit 334-OKE00	08.05.2014	Winkler
334_OKE00	2	Frontansicht SM 334 AI 4/AO 2x12Bit 334-OKE00	30.11.2010	Winkler
334_OKE00	3	Eingangskanal 0-1 SM 334 AI 4/AO 2x12Bit 334-OKE00	08.05.2014	Winkler
334_OKE00	4	Eingangskanal 2-3 SM 334 AI 4/AO 2x12Bit 334-OKE00	08.05.2014	Winkler
334_OKE00	5	Ausgangskanal 0-1 SM 334 AI 4/AO 2x12Bit 334-OKE00	08.05.2014	Winkler
341_1AH01	1	SPS-Übersicht CP 341-RS232 341-1AH01	08.05.2014	Winkler
341_1AH01	2	Frontansicht CP 341-RS232 341-1AH01	08.05.2014	Winkler
341_1AH01	3	Anschlußbelegung CP 341-RS232 341-1AH01	08.05.2014	Winkler
341_1CH01	1	SPS-Übersicht CP 341-RS422/485 341-1CH01	08.05.2014	Winkler
341_1CH01	2	Frontansicht CP 341-RS422/485 341-1CH01	08.05.2014	Winkler
341_1CH01	3	Anschlußbelegung CP 341-RS422/485 341-1CH01	08.05.2014	Winkler
341_2CH71	1	SPS-Übersicht CP 341S-2RS422/485, 341-2CH71	08.05.2014	Winkler
341_2CH71	2	Frontansicht CP 341S-2RS422/485, 341-2CH71	30.11.2010	Winkler
341_2CH71	3	Anschlußbelegung CP 341S-2RS422/485, 341-2CH71	08.05.2014	Winkler
342_1CA70	1	SPS-Übersicht CP 342S-CAN, 342-1CA70	08.05.2014	Winkler
342_1CA70	2	Frontansicht CP 342S-CAN, 342-1CA70	30.11.2010	Winkler
342_1CA70	3	Anschlußbelegung CP 342S-CAN, 342-1CA70	08.05.2014	Winkler
342_1DA70	1	SPS-Übersicht CP 342S-DP, 342-1DA70	08.05.2014	Winkler
342_1DA70	2	Frontansicht CP 342S-DP, 342-1DA70	30.11.2010	Winkler
342_1DA70	3	Anschlußbelegung CP 342S-DP, 342-1DA70	08.05.2014	Winkler
342_1IA70	1	SPS-Übersicht CP 342S-IBS, 342-1IA70	08.05.2014	Winkler
342_1IA70	2	Frontansicht CP 342S-IBS, 342-1IA70	30.11.2010	Winkler
342_1IA70	3	Anschlußbelegung CP 342S-IBS, 342-1IA70	08.05.2014	Winkler
342_2IA71	1	SPS-Übersicht CP 342S-2IBS, 342-2IA71	08.05.2014	Winkler
342_2IA71	2	Frontansicht CP 342S-2IBS, 342-2IA71	30.11.2010	Winkler
342_2IA71	3	Anschlußbelegung CP 342S-2IBS, 342-2IA71	08.05.2014	Winkler
343_1EX71	1	SPS-Übersicht CP 343S-NET, 343-1EX71	08.05.2014	Winkler
343_1EX71	2	Frontansicht CP 343S-NET, 343-1EX71	30.11.2010	Winkler
343_1EX71	3	Anschlußbelegung CP 343S-NET, 343-1EX71	08.05.2014	Winkler
343_2AH10	1	SPS-Übersicht CP343-2P AS-i 343-2AH10	08.05.2014	Winkler
343_2AH10	2	Frontansicht CP343-2P AS-i 343-2AH10	30.11.2010	Winkler
343_2AH10	3	Anschlußbelegung CP343-2P AS-i 343-2AH10	08.05.2014	Winkler
353_1DP01	1	SPS-Übersicht IM 353DP-DP-Slave 353-1DP01	08.05.2014	Winkler
353_1DP01	2	Frontansicht IM 353DP-DP-Slave 353-1DP01	08.05.2014	Winkler
353_1DP01	3	Anschlußbelegung IM 353DP-DP-Slave 353-1DP01	08.05.2014	Winkler

Datum	20.12.2016	Produktmakros System 300S		
Bearb.	Winkler			
Gepr.				
Änderung	Datum	Name	Urspr	Ersatz von



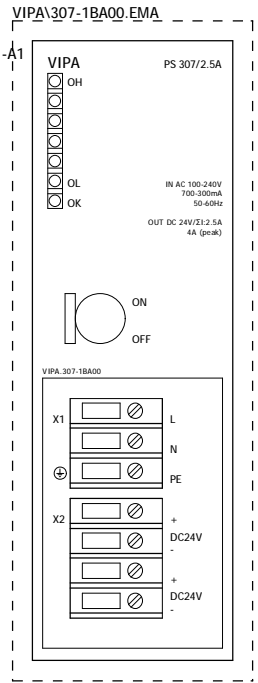

+DOK/14

			Datum	29.11.2010	Produktmakros System 300S
			Bearb.	Winkler	
			Gepr		
Anderung	Datum	Name	Urspr		Ersatz von



Frontansicht
PS 307/2.5A,
307-1BA00

		=
		+ 307_1BA00
	Blatt	1
	Blatt	387

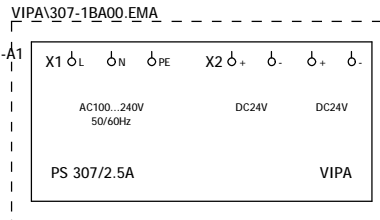

1

+307_1EA00/1

			Datum	08.05.2014	Produktmakros System 300S	YASKAWA	Anschlußbelegung PS 307/2,5A, 307-1BA00		=	+ 307_1BA00	Blatt	2
			Bearb.	Winkler							Blatt	387
			Gepr									
Anderung	Datum	Name	Urspr		Ersatz von							

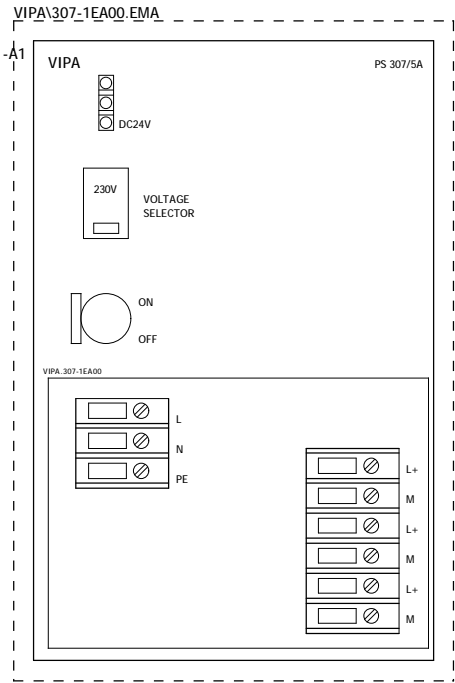

			Datum	29.11.2010	Produktmakros System 300S
			Bearb.	Winkler	
			Gepr		
Anderung	Datum	Name	Urspr		Ersatz von



		=
		+ 307_1EA00
		Blatt 1
		Blatt 387

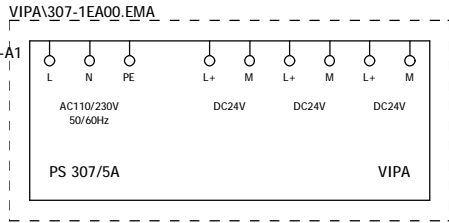

			Datum	08.05.2014	Produktmakros System 300S	YASKAWA	Anschlußbelegung PS 307/5A, 307-1EA00		=	+ 307_1EA00	Blatt	2
			Bearb.	Winkler							Blatt	387
			Gepr									
Anderung	Datum	Name	Urspr		Ersatz von							

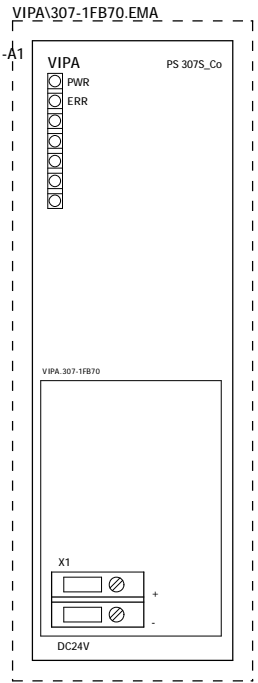

+307_1EA00/2

2

			Datum	29.11.2010	Produktmakros System 300S
			Bearb.	Winkler	
			Gepr		
Anderung	Datum	Name	Urspr		Ersatz von



Frontansicht
PS 307S_Co,
307-1FB70

=
+ 307_1FB70

VIPA\307-1FB70.EMA

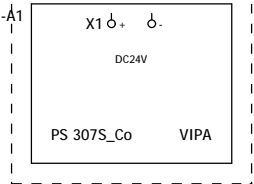

1

+307_1KA00/1

			Datum	08.05.2014	Produktmakros System 300S		Anschlußbelegung PS 307S_Co, 307-1FB70		=	+ 307_1FB70	Blatt	2
			Bearb.	Winkler							Blatt	387
			Gepr									
Anderung	Datum	Name	Urspr		Ersatz von							

VIPA\307-1KA00.EMA

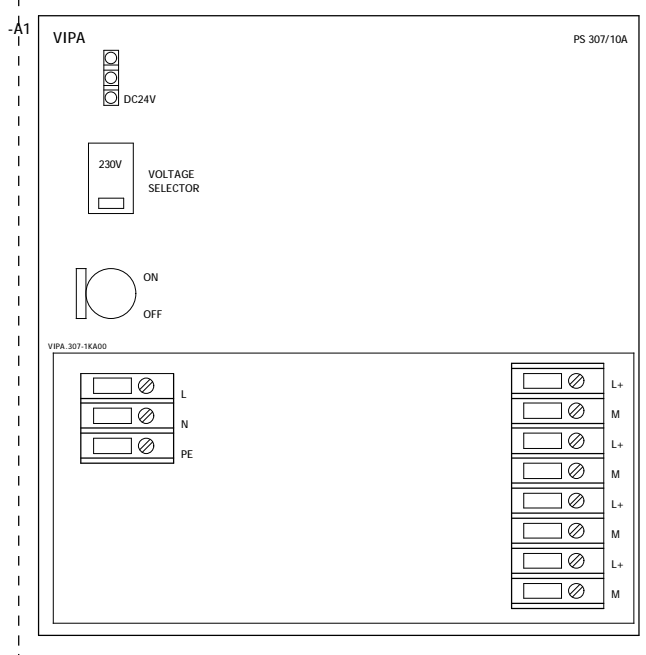

+307_1FB70/2

2

			Datum	29.11.2010	Produktmakros System 300S
			Bearb.	Winkler	
			Gepr		
Anderung	Datum	Name	Urspr		Ersatz von



Frontansicht
PS 307/10A,
307-1KA00

		=
		+ 307_1KA00
		Blatt 1
		Blatt 387

VIPA\307-1KA00.EMA

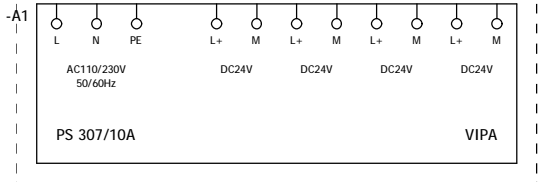

1

+312_5BE03/1

			Datum	08.05.2014	Produktmakros System 300S
			Bearb.	Winkler	
			Gepr.		
Anderung	Datum	Name	Urspr.		Ersatz von



Anschlußbelegung
PS 307/10A,
307-1KA00

		=
		+ 307_1KA00
		Blatt 2
		Blatt 387

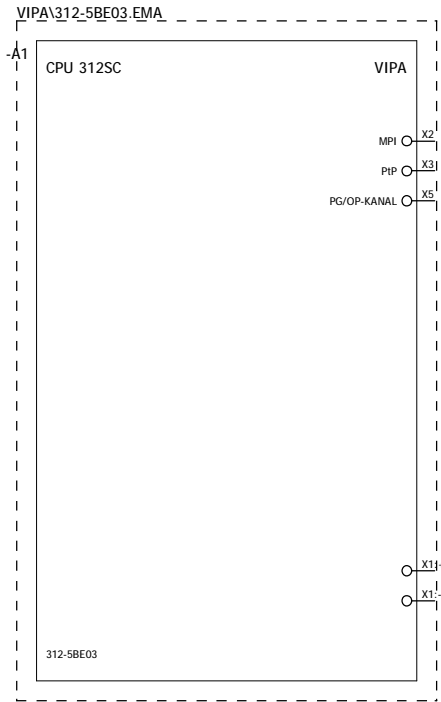

+307_1KA00/2

2

			Datum	08.05.2014	Produktmakros System 300S
			Bearb.	Winkler	
			Gepr		
Anderung	Datum	Name	Urspr		Ersatz von



SPS-Übersicht
 CPU 312SC,
 312-5BE03

		=
		+ 312_5BE03
		Blatt 1
		Blatt 387

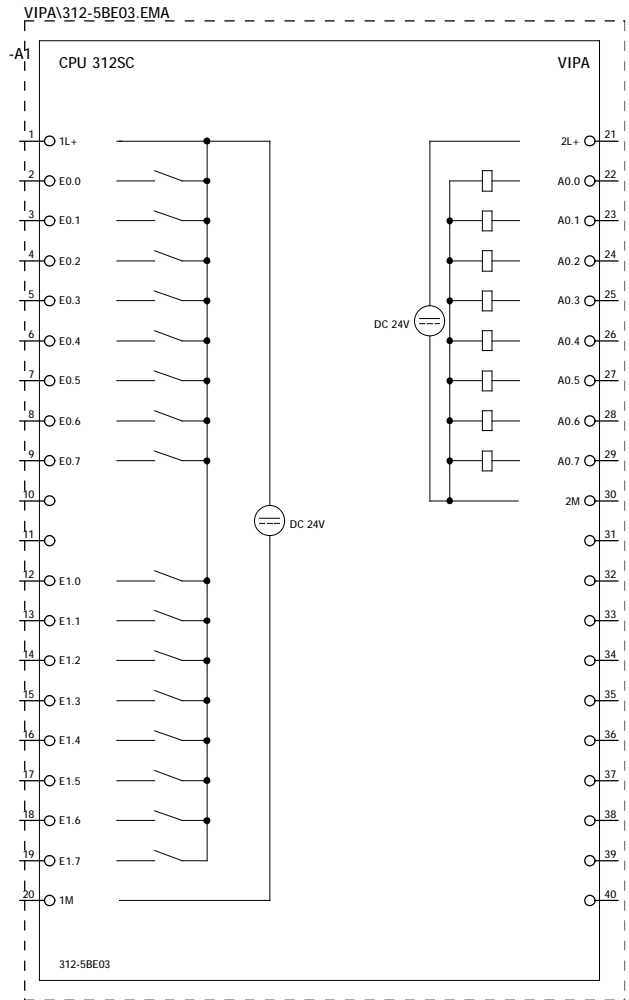

			Datum	08.05.2014	Produktmakros System 300S
			Bearb.	Winkler	
			Gepr.		
Anderung	Datum	Name	Urspr.		Ersatz von



SPS-Übersicht E/A-Bereich
CPU 312SC,
312-5BE03

		=
		+ 312_5BE03
		Blatt 2
		Blatt 387

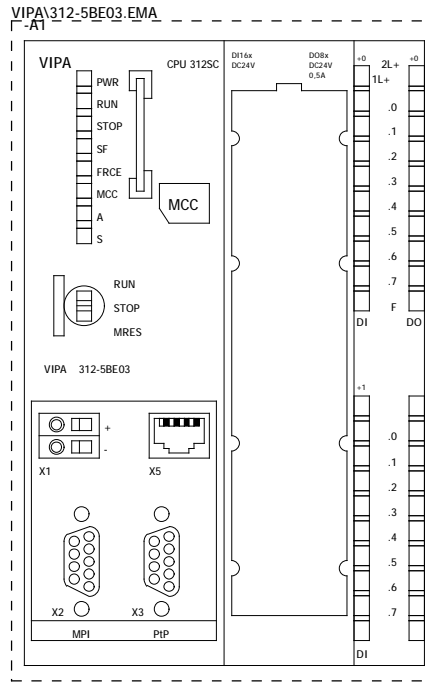

			Datum	29.11.2010	Produktmakros System 300S
			Bearb.	Winkler	
			Gepr		
Anderung	Datum	Name	Urspr		Ersatz von



Frontansicht
CPU 312SC,
312-5BE03

		=
		+ 312_5BE03
	Blatt	3
	Blatt	387

VIPA\312-5BE03.EMA

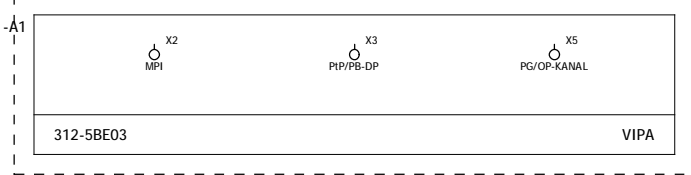

VIPA\312-5BE03.EMA

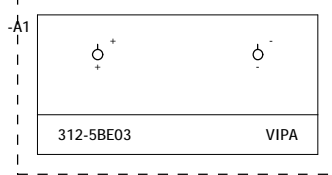

			Datum	08.05.2014	Produktmakros System 300S
			Bearb.	Winkler	
			Gepr.		
Anderung	Datum	Name	Urspr.		Ersatz von



Anschlußbelegung
CPU 312SC,
312-5BE03

		=	
		+ 312_5BE03	
			Blatt 4
			Blatt 387

VIPA\312-5BE03.EMA

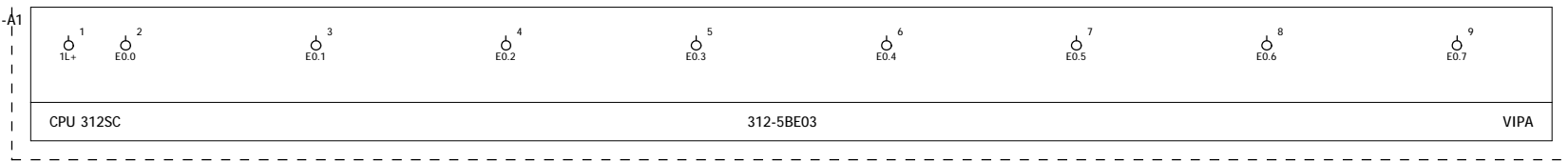

4

6

			Datum	08.05.2014	Produktmakros System 300S	YASKAWA	Eingangsbyte 0 CPU 312SC, 312-5BE03	=	+ 312_5BE03	Blatt 5
			Bearb.	Winkler						
			Gepr							
Anderung	Datum	Name	Urspr		Ersatz von					Blatt 387

VIPA\312-5BE03.EMA

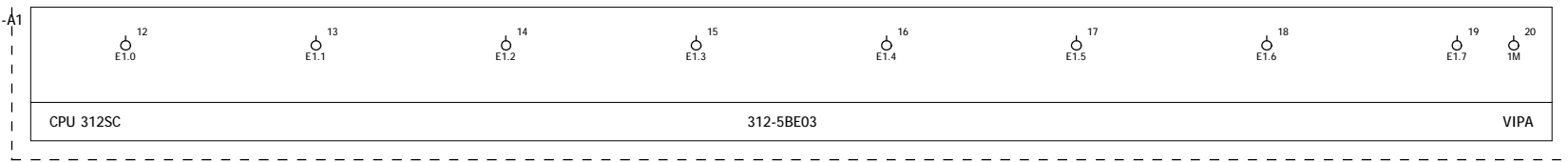

			Datum	08.05.2014	Produktmakros System 300S	YASKAWA	Eingangsbyte 1 CPU 312SC, 312-5BE03		=	+ 312_5BE03	Blatt 6
			Bearb.	Winkler							
			Gepr								
Anderung	Datum	Name	Urspr		Ersatz von						Blatt 387

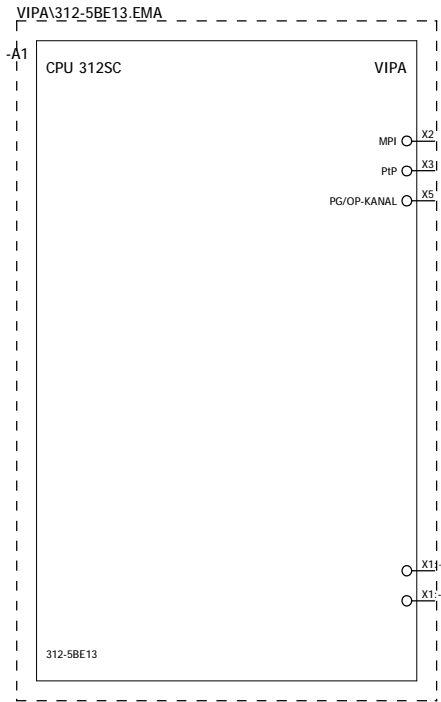

+312_5BE03/7

2

			Datum	08.05.2014	Produktmakros System 300S
			Bearb.	Winkler	
			Gepr		
Anderung	Datum	Name	Urspr		Ersatz von



SPS-Übersicht
CPU 312SC,
312-5BE13

		=
		+ 312_5BE13
		Blatt 1
		Blatt 387

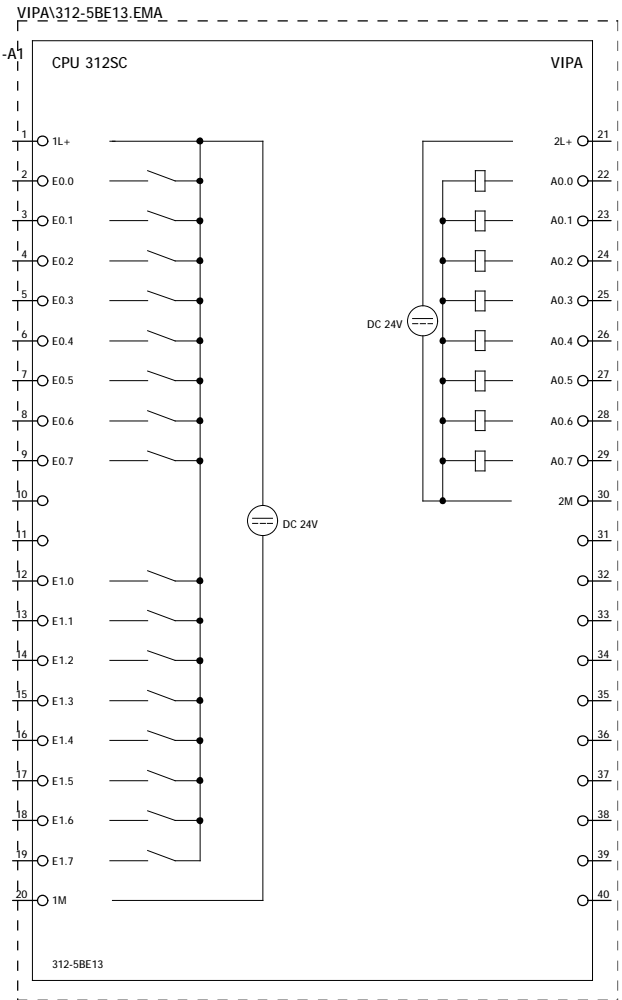

			Datum	08.05.2014	Produktmakros System 300S
			Bearb.	Winkler	
			Gepr.		
Anderung	Datum	Name	Urspr		Ersatz von



SPS-Übersicht E/A-Bereich
CPU 312SC,
312-5BE13

		=
		+ 312_5BE13
		Blatt 2
		Blatt 387

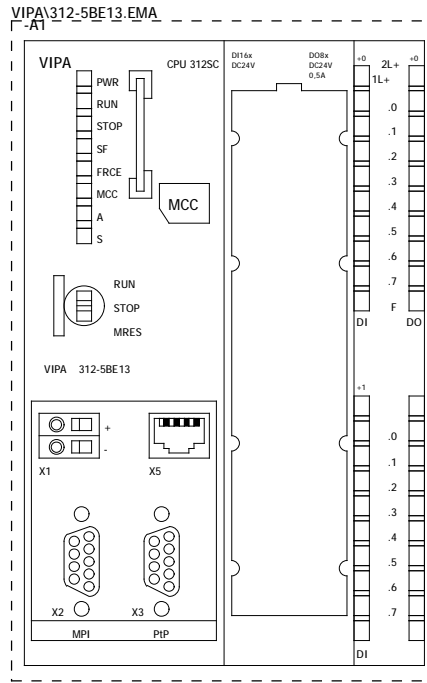

			Datum	29.10.2011	Produktmakros System 300S
			Bearb.	Winkler	
			Gepr.		
Anderung	Datum	Name	Urspr		Ersatz von



Frontansicht
CPU 312SC,
312-5BE13

		=
		+ 312_5BE13
		Blatt 3
		Blatt 387

VIPA\312-5BE13.EMA

-A1

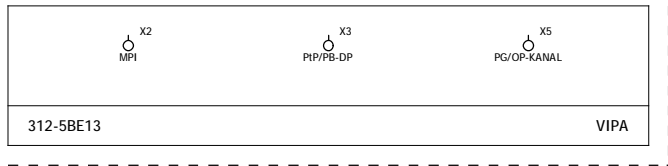

VIPA\312-5BE13.EMA

-A1

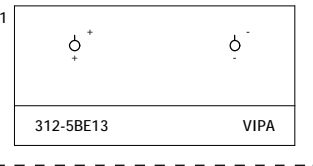

			Datum	08.05.2014	Produktmakros System 300S
			Bearb.	Winkler	
			Gepr		
Anderung	Datum	Name	Urspr		Ersatz von



Anschlußbelegung
CPU 312SC,
312-5BE13

		=	
		+ 312_5BE13	
			Blatt 4
			Blatt 387

VIPA\312-5BE13.EMA

A1

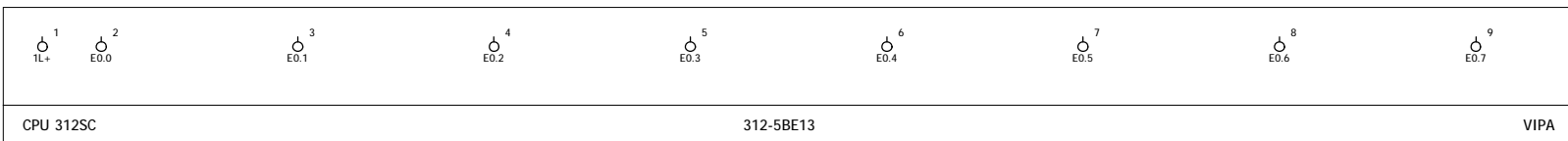

			Datum	08.05.2014	Produktmakros System 300S	YASKAWA	Eingangsbyte 0 CPU 312SC, 312-5BE13	=	+ 312_5BE13	Blatt 5
			Bearb.	Winkler						
			Gepr							
Anderung	Datum	Name	Urspr		Ersatz von					Blatt 387

VIPA\312-5BE13.EMA

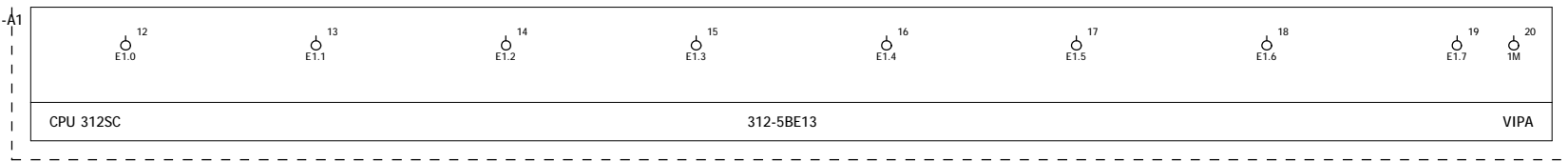

			Datum	08.05.2014	Produktmakros System 300S	YASKAWA	Eingangsbyte 1 CPU 312SC, 312-5BE13	=	+ 312_5BE13	Blatt	6
			Bearb.	Winkler							
			Gepr								
Anderung	Datum	Name	Urspr		Ersatz von					Blatt	387

VIPA\312-5BE13.EMA

A1



			Datum	08.05.2014	Produktmakros System 300S
			Bearb.	Winkler	
			Gepr		
Anderung	Datum	Name	Urspr		Ersatz von



Ausgangsbyte 0
CPU 312SC,
312-5BE13

	=	
	+ 312_5BE13	
		Blatt 7
		Blatt 387

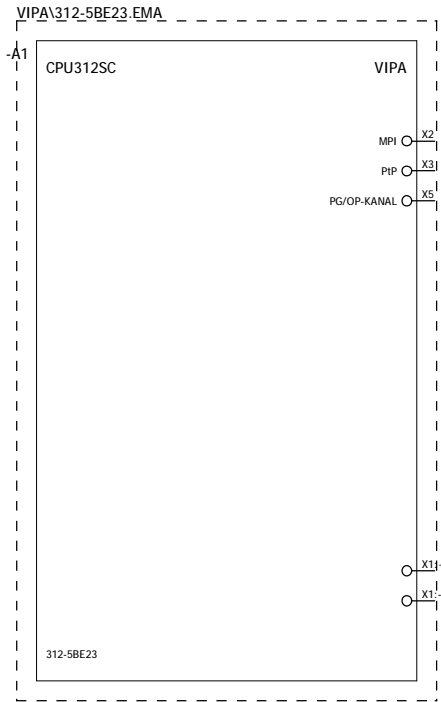

+312_5BE13/7

			Datum	19.12.2016	Produktmakros System 300S		SPS-Übersicht CPU 312SC, 312-5BE23		=	+ 312_5BE23	Blatt	1
			Bearb.	Winkler							Blatt	387
			Gepr									
Anderung	Datum	Name	Urspr		Ersatz von							

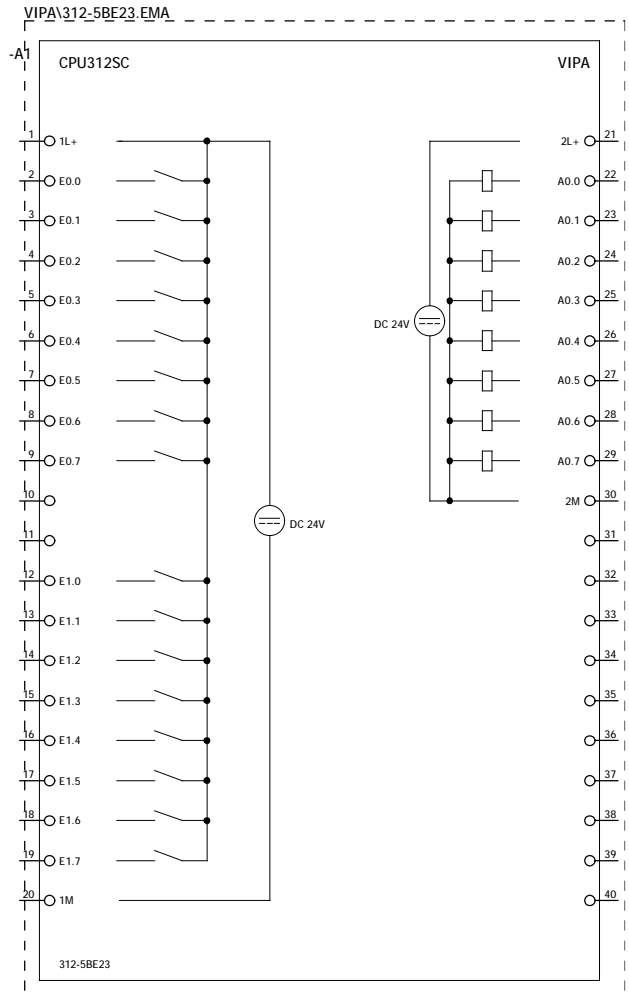

			Datum	19.12.2016	Produktmakros System 300S
			Bearb.	Winkler	
			Gepr.		
Anderung	Datum	Name	Urspr.		Ersatz von



SPS-Übersicht E/A-Bereich
CPU 312SC,
312-5BE23

		=
		+ 312_5BE23
		Blatt 2
		Blatt 387

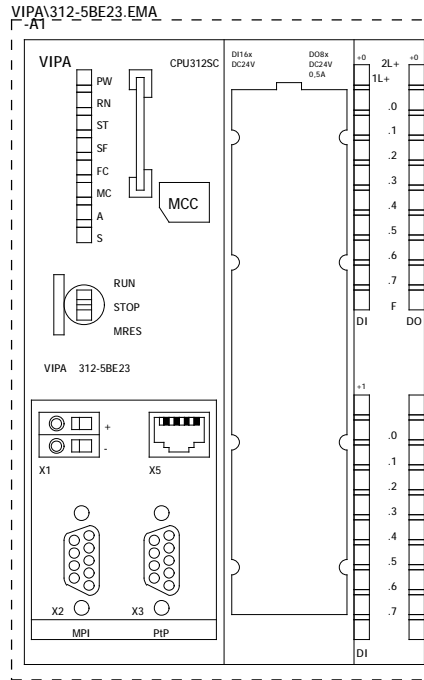

			Datum	20.12.2016	Produktmakros System 300S
			Bearb.	Winkler	
			Gepr		
Anderung	Datum	Name	Urspr		Ersatz von



Frontansicht
CPU 312SC,
312-5BE23

		=
		+ 312_5BE23
		Blatt 3
		Blatt 387

VIPA\312-5BE23.EMA

-A1

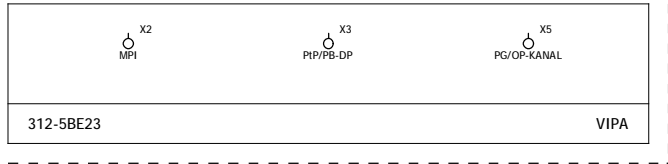

VIPA\312-5BE23.EMA

-A1

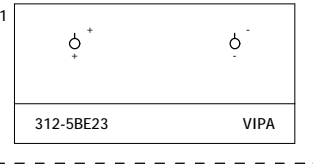

			Datum	19.12.2016	Produktmakros System 300S
			Bearb.	Winkler	
			Gepr.		
Anderung	Datum	Name	Urspr		Ersatz von



Anschlußbelegung
CPU 312SC,
312-5BE23

		=
		+ 312_5BE23
		Blatt 4
		Blatt 387

VIPA\312-5BE23.EMA

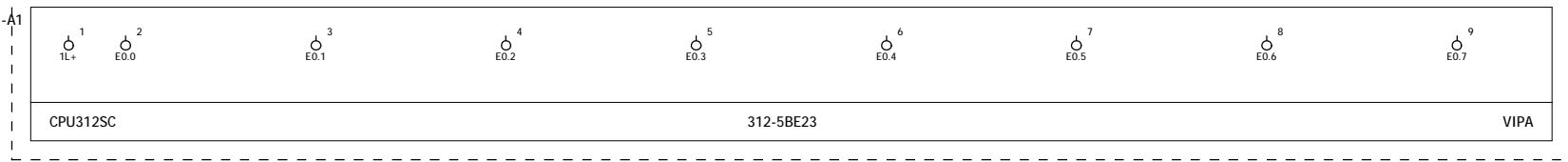

			Datum	19.12.2016	Produktmakros System 300S	YASKAWA	Eingangsbyte 0 CPU 312SC, 312-5BE23	=	+ 312_5BE23	Blatt	5
			Bearb.	Winkler							
			Gepr								
Anderung	Datum	Name	Urspr		Ersatz von					Blatt	387

VIPA\312-5BE23.EMA

A1

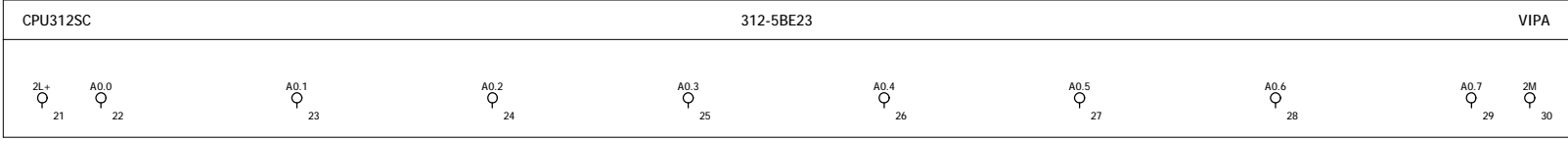

			Datum	19.12.2016	Produktmakros System 300S	YASKAWA	Ausgangsbyte 0 CPU 312SC, 312-5BE23	=	+ 312_5BE23	Blatt	7
			Bearb.	Winkler						Blatt	387
			Gepr								
Anderung	Datum	Name	Urspr		Ersatz von						

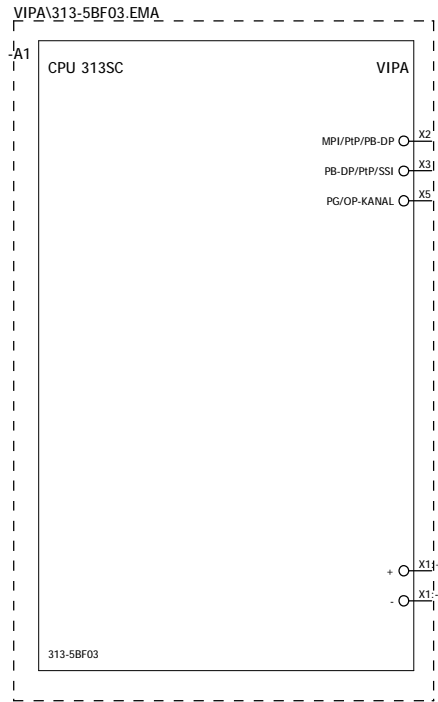

+312_5BE23/7

2

			Datum	08.05.2014	Produktmakros System 300S	YASKAWA	SPS-Übersicht CPU 313SC, 313-5BF03		=	+ 313_5BF03	Blatt	1
			Bearb.	Winkler							Blatt	387
			Gepr									
Anderung	Datum	Name	Urspr		Ersatz von							

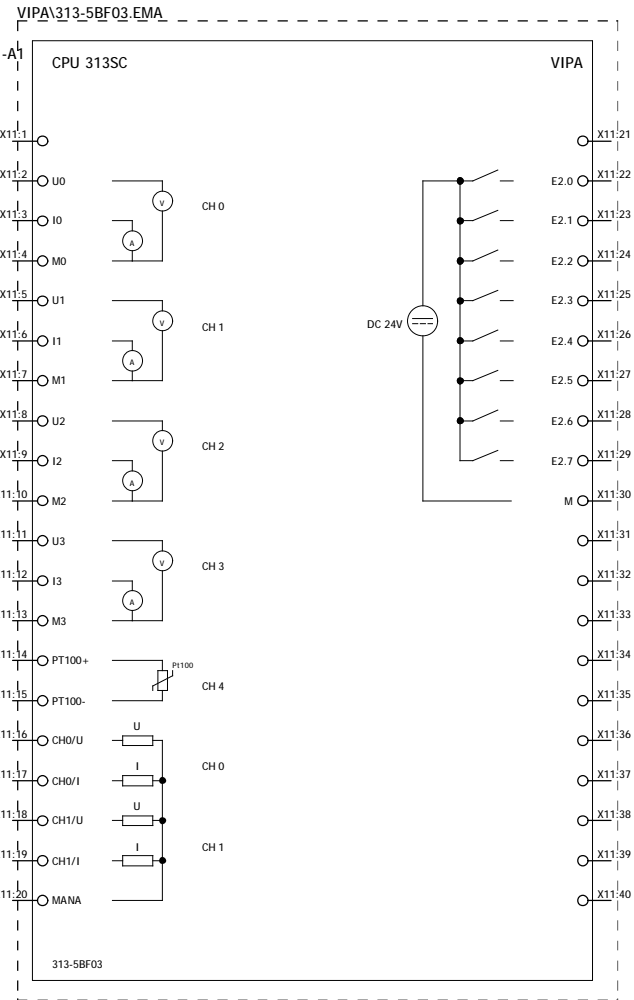

			Datum	08.05.2014	Produktmakros System 300S
			Bearb.	Winkler	
			Gepr.		
Anderung	Datum	Name	Urspr		Ersatz von



SPS-Übersicht
CPU 313SC,
313-5BF03

		=
		+ 313_5BF03
	Blatt	2
	Blatt	387

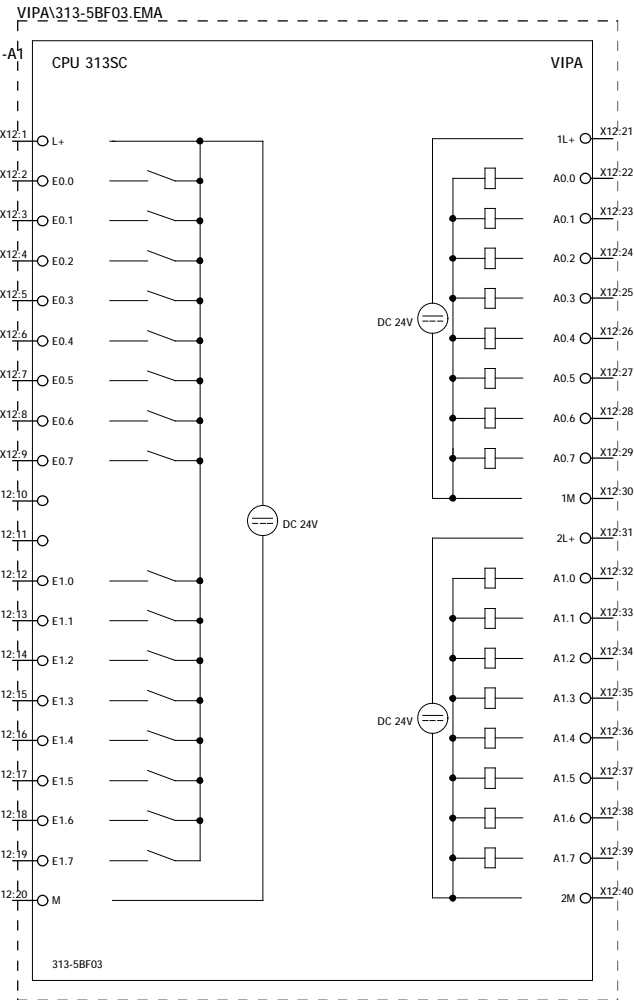

			Datum	08.05.2014	Produktmakros System 300S
			Bearb.	Winkler	
			Gepr.		
Anderung	Datum	Name	Urspr		Ersatz von



SPS-Übersicht E/A-Bereich
CPU 313SC,
313-5BF03

		=
		+ 313_5BF03
		Blatt 3
		Blatt 387

VIPA\313-5BF03.EMA

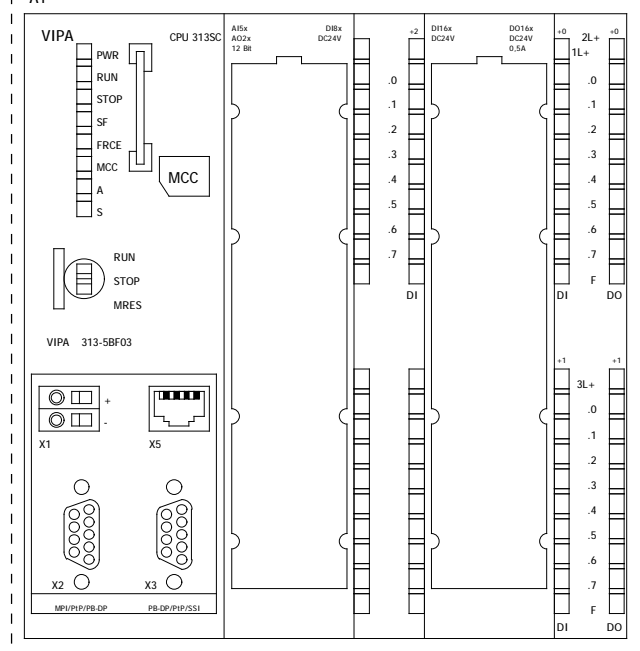

			Datum	29.11.2010	Produktmakros System 300S
			Bearb.	Winkler	
			Gepr		
Anderung	Datum	Name	Urspr		Ersatz von



Frontansicht
CPU 313SC,
313-5BF03

		=
		+ 313_5BF03
	Blatt	4
	Blatt	387

VIPA\313-5BF03.EMA

-A1

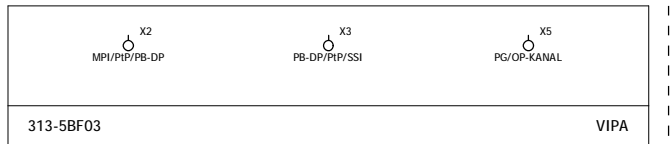

VIPA\313-5BF03.EMA

-A1

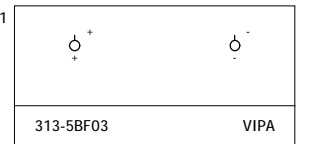

			Datum	08.05.2014	Produktmakros System 300S
			Bearb.	Winkler	
			Gepr.		
Anderung	Datum	Name	Urspr		Ersatz von



Anschlußbelegung
CPU 313SC,
313-5BF03

		=
		+ 313_5BF03
		Blatt 5
		Blatt 387

VIPA\313-5BF03.EMA

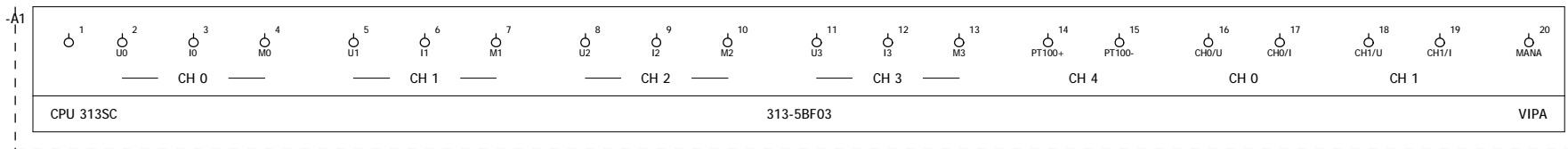

			Datum	08.05.2014	Produktmakros System 300S	YASKAWA	Analoge Ein-/Ausgänge CPU 313SC, 313-5BF03		=	+ 313_5BF03	Blatt	6
			Bearb.	Winkler								
			Gepr									
Anderung	Datum	Name	Urspr		Ersatz von						Blatt	387

VIPA\313-5BF03.EMA

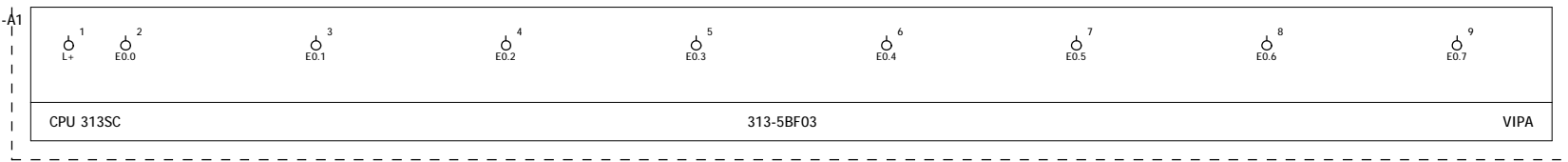

			Datum	08.05.2014	Produktmakros System 300S	YASKAWA	Eingangsbyte 0 CPU 313SC, 313-5BF03	=	+ 313_5BF03	Blatt	8
			Bearb.	Winkler						Blatt	387
			Gepr								
Anderung	Datum	Name	Urspr		Ersatz von						

VIPA\313-5BF03.EMA

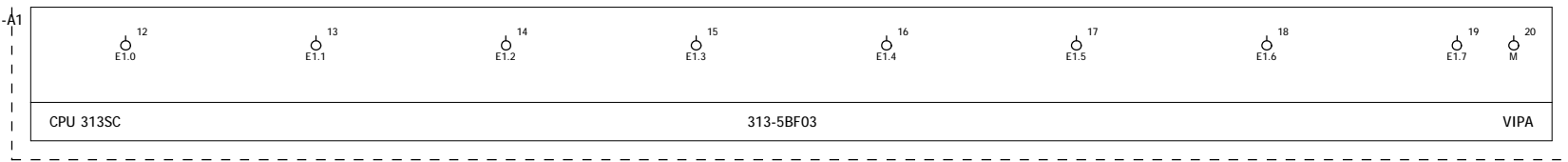

			Datum	08.05.2014	Produktmakros System 300S	YASKAWA	Eingangsbyte 1 CPU 313SC, 313-5BF03	=	+ 313_5BF03	Blatt	9
			Bearb.	Winkler							
			Gepr								
Anderung	Datum	Name	Urspr		Ersatz von					Blatt	387

VIPA\313-5BF03.EMA

A1

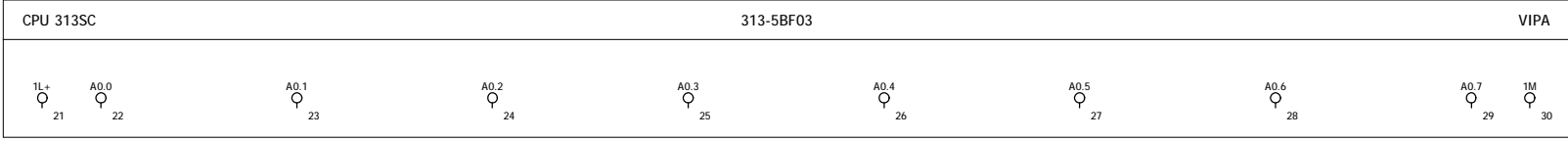

			Datum	08.05.2014	Produktmakros System 300S	YASKAWA	Ausgangsbyte 0 CPU 313SC, 313-5BF03	=	+ 313_5BF03	Blatt 10
			Bearb.	Winkler						
			Gepr							
Anderung	Datum	Name	Urspr		Ersatz von					Blatt 387

VIPA\313-5BF03.EMA

A1

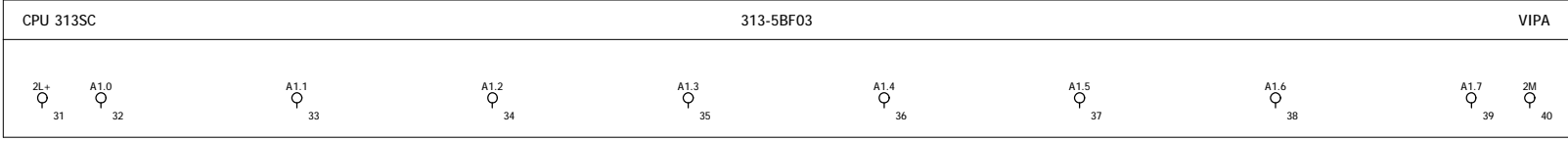

			Datum	08.05.2014	Produktmakros System 300S	YASKAWA	Ausgangsbyte 1 CPU 313SC, 313-5BF03		=	+ 313_5BF03	Blatt	11
			Bearb.	Winkler							Blatt	387
			Gepr									
Anderung	Datum	Name	Urspr		Ersatz von							

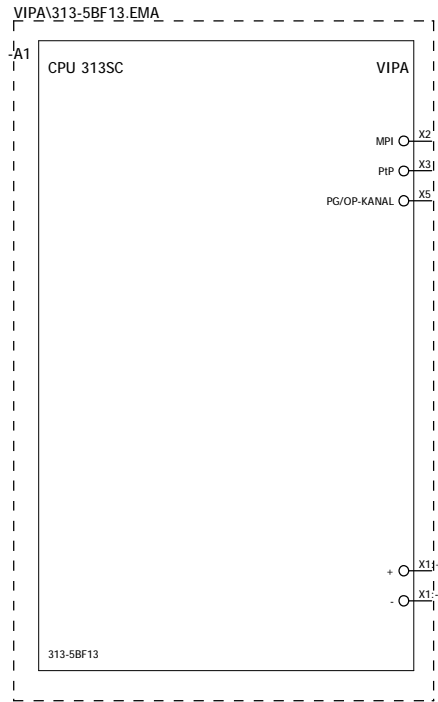

+313_5BF03/11

			Datum	08.05.2014	Produktmakros System 300S		SPS-Übersicht CPU 313SC, 313-5BF13		=	+ 313_5BF13	Blatt	1
			Bearb.	Winkler							Blatt	387
			Gepr									
Anderung	Datum	Name	Urspr		Ersatz von							

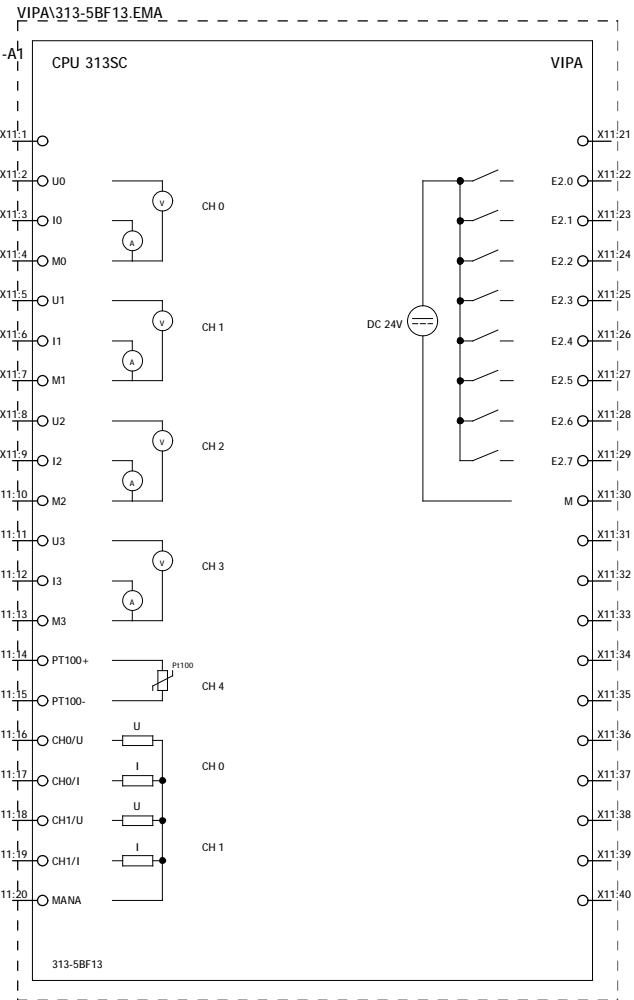

			Datum	08.05.2014	Produktmakros System 300S
			Bearb.	Winkler	
			Gepr.		
Anderung	Datum	Name	Urspr		Ersatz von



SPS-Übersicht
CPU 313SC,
313-5BF13

		=
		+ 313_5BF13
	Blatt	2
	Blatt	387

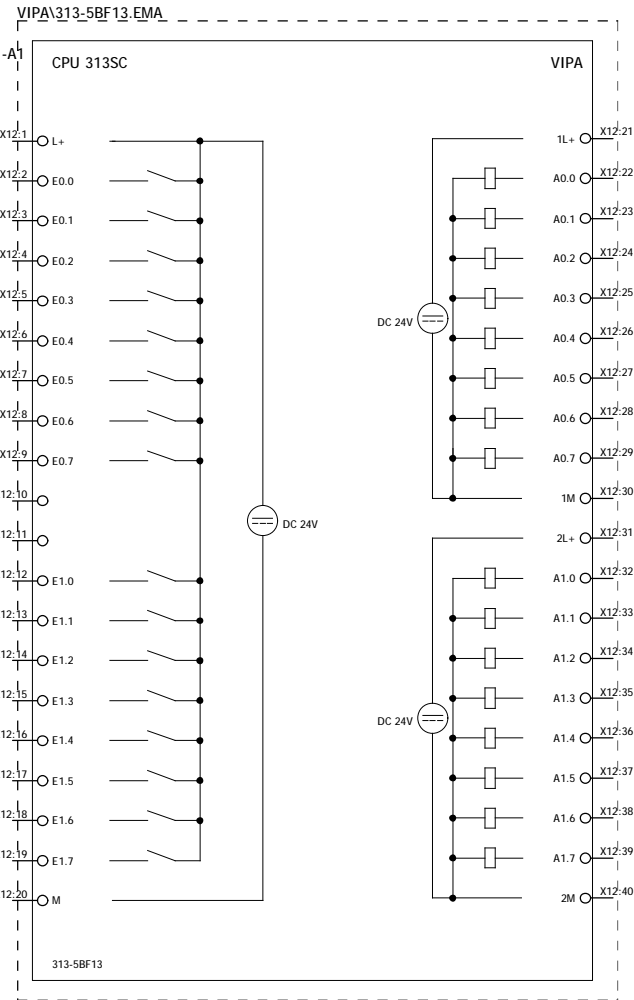

			Datum	08.05.2014	Produktmakros System 300S
			Bearb.	Winkler	
			Gepr.		
Anderung	Datum	Name	Urspr		Ersatz von



SPS-Übersicht E/A-Bereich
CPU 313SC,
313-5BF13

		=
		+ 313_5BF13
		Blatt 3
		Blatt 387

VIPA\313-5BF13.EMA
-A1

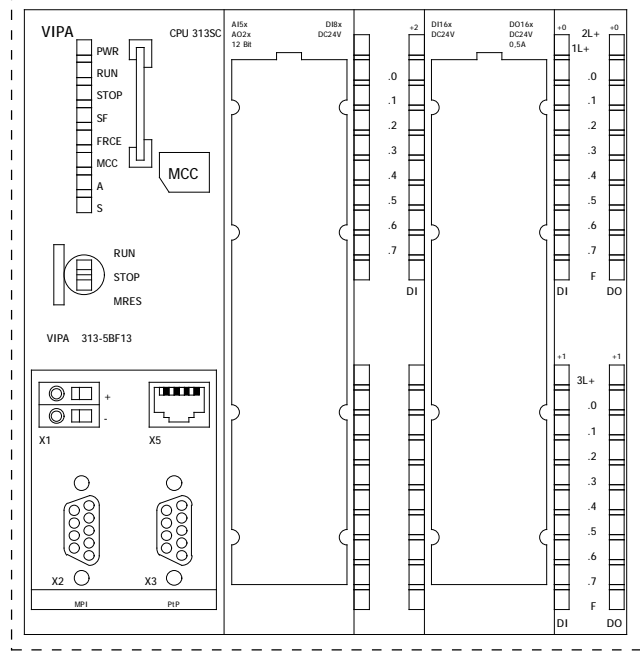

			Datum	03.11.2011	Produktmakros System 300S
			Bearb.	Winkler	
			Gepr.		
Anderung	Datum	Name	Urspr		Ersatz von



Frontansicht
CPU 313SC,
313-5BF13

		=
		+ 313_5BF13
	Blatt	4
	Blatt	387

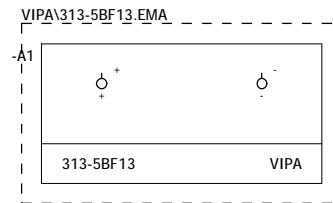
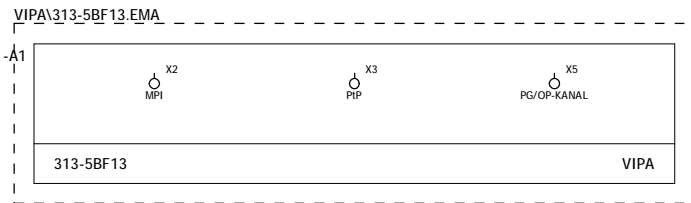

			Datum	08.05.2014	Produktmakros System 300S
			Bearb.	Winkler	
			Gepr.		
Anderung	Datum	Name	Urspr		Ersatz von



Anschlußbelegung
CPU 313SC,
313-5BF13

		=
		+ 313_5BF13
		Blatt 5
		Blatt 387

VIPA\313-5BF13.EMA

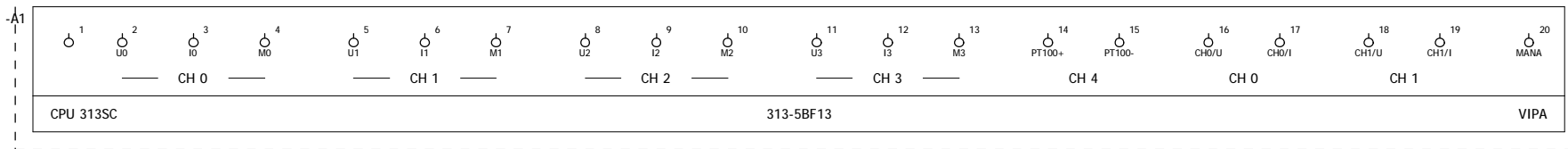

			Datum	08.05.2014	Produktmakros System 300S	YASKAWA	Analoge Ein-/Ausgänge CPU 313SC, 313-5BF13		=	+ 313_5BF13	Blatt 6
			Bearb.	Winkler							
			Gepr.								
Anderung	Datum	Name	Urspr		Ersatz von						Blatt 387

VIPA\313-5BF13.EMA

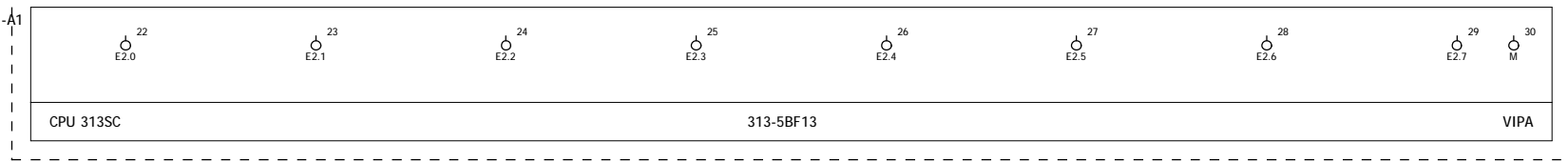

			Datum	08.05.2014	Produktmakros System 300S	YASKAWA	Eingangsbyte 2 CPU 313SC, 313-5BF13	=	+ 313_5BF13	Blatt 7
			Bearb.	Winkler						
			Gepr							
Anderung	Datum	Name	Urspr		Ersatz von					Blatt 387

VIPA\313-5BF13.EMA

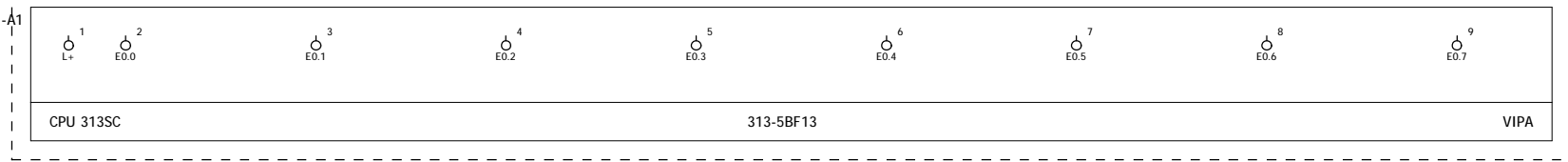

			Datum	08.05.2014	Produktmakros System 300S	YASKAWA	Eingangsbyte 0 CPU 313SC, 313-5BF13	=	+ 313_5BF13	Blatt	8
			Bearb.	Winkler							
			Gepr								
Anderung	Datum	Name	Urspr		Ersatz von					Blatt	387

VIPA\313-5BF13.EMA

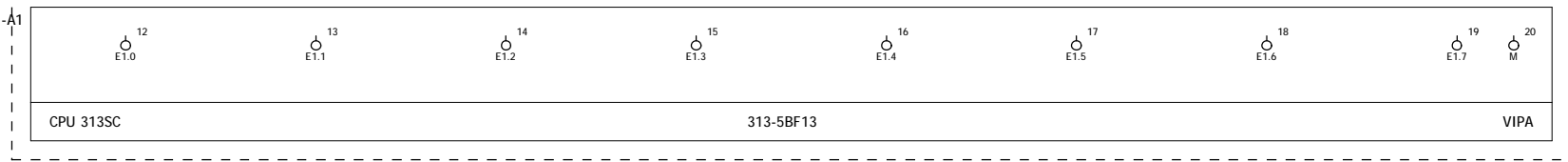

			Datum	08.05.2014	Produktmakros System 300S	YASKAWA	Eingangsbyte 1 CPU 313SC, 313-5BF13		=	+ 313_5BF13	Blatt 9
			Bearb.	Winkler							
			Gepr								
Anderung	Datum	Name	Urspr		Ersatz von						Blatt 387

VIPA\313-5BF13.EMA

A1

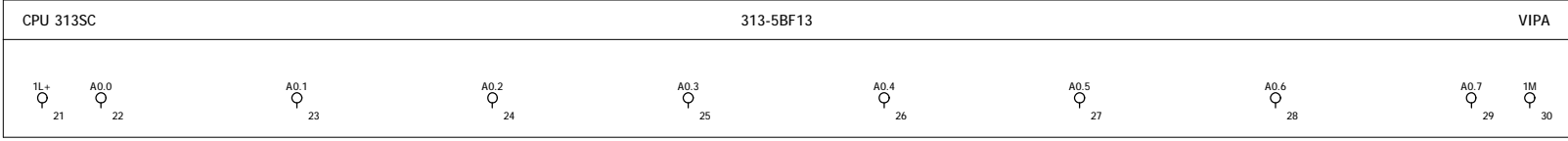

			Datum	08.05.2014	Produktmakros System 300S	YASKAWA	Ausgangsbyte 0 CPU 313SC, 313-5BF13	=	+ 313_5BF13	Blatt 10
			Bearb.	Winkler						
			Gepr							
Anderung	Datum	Name	Urspr		Ersatz von					Blatt 387

VIPA\313-5BF13.EMA

A1

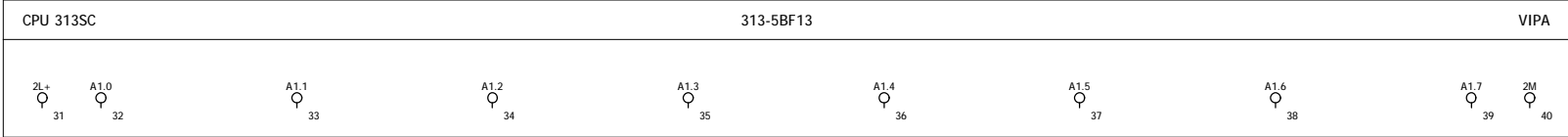

			Datum	08.05.2014	Produktmakros System 300S	YASKAWA	Ausgangsbyte 1 CPU 313SC, 313-5BF13		=	+ 313_5BF13	Blatt	11
			Bearb.	Winkler							Blatt	387
			Gepr									
Anderung	Datum	Name	Urspr		Ersatz von							

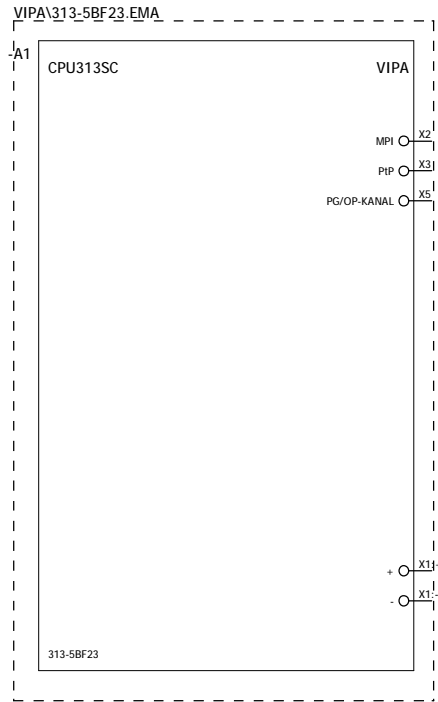

+313_5BF13/11

			Datum	19.12.2016	Produktmakros System 300S
			Bearb.	Winkler	
			Gepr		
Anderung	Datum	Name	Urspr		Ersatz von



SPS-Übersicht
CPU 313SC,
313-5BF23

=	
+ 313_5BF23	
Blatt	1
Blatt	387

VIPA\313-5BF23.EMA

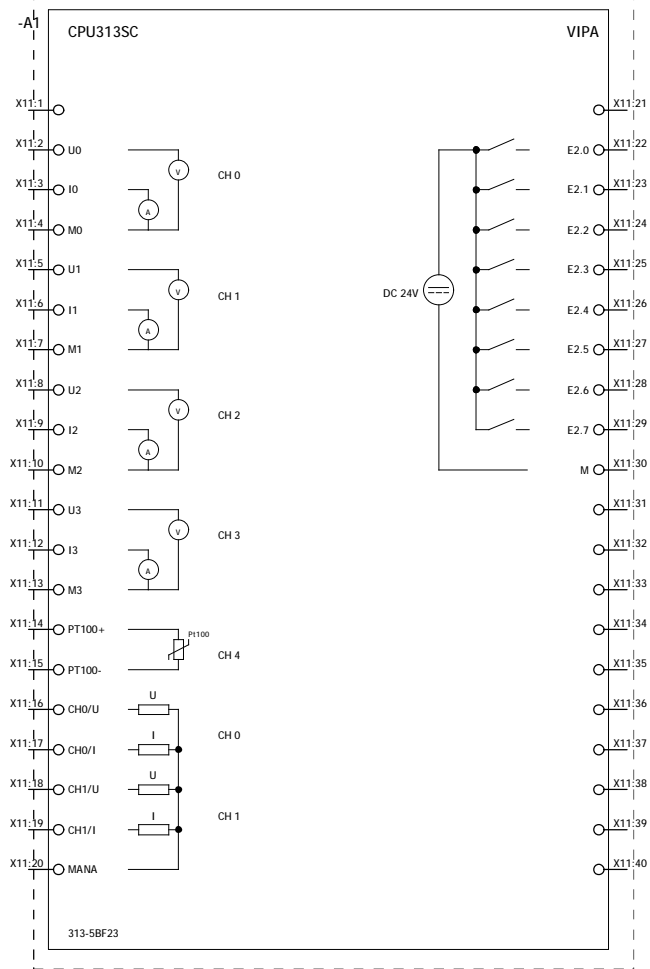

			Datum	19.12.2016	Produktmakros System 300S
			Bearb.	Winkler	
			Gepr.		
Anderung	Datum	Name	Urspr		Ersatz von



SPS-Übersicht
CPU 313SC,
313-5BF23

		=
		+ 313_5BF23
		Blatt 2
		Blatt 387

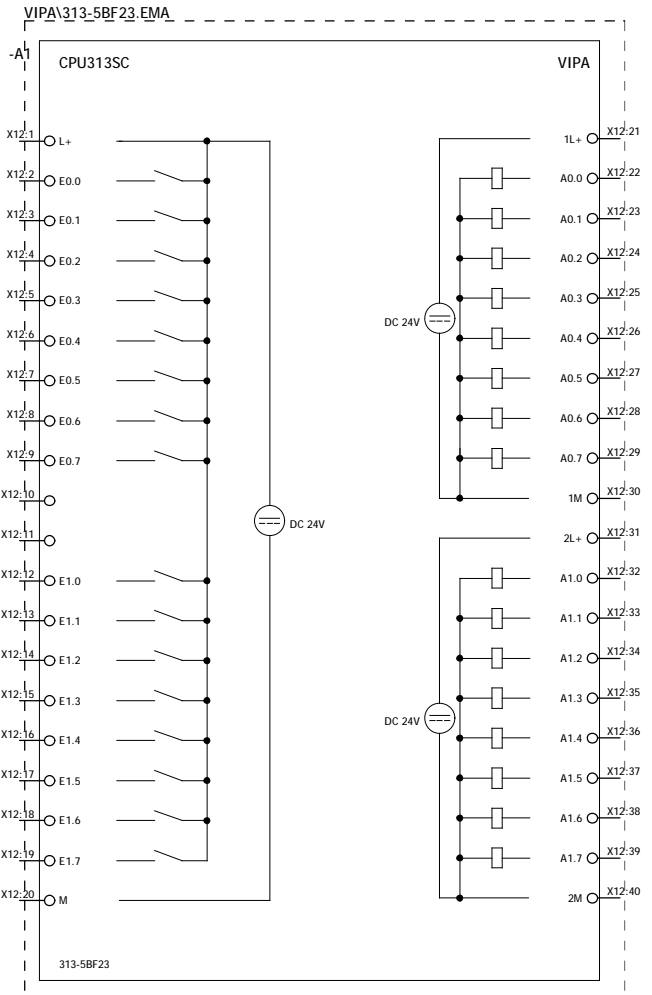

			Datum	19.12.2016	Produktmakros System 300S
			Bearb.	Winkler	
			Gepr.		
Anderung	Datum	Name	Urspr		Ersatz von



SPS-Übersicht E/A-Bereich
CPU 313SC,
313-5BF23

		=
		+ 313_5BF23
		Blatt 3
		Blatt 387

VIPA\313-5BF23.EMA

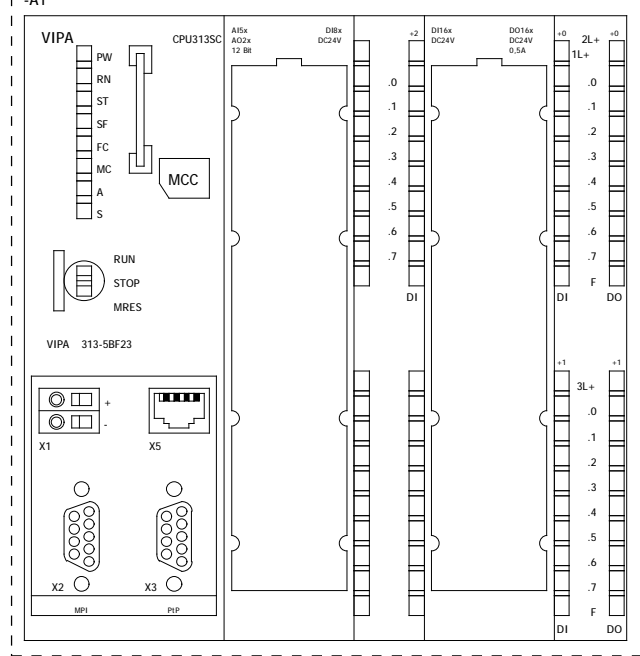

			Datum	20.12.2016	Produktmakros System 300S
			Bearb.	Winkler	
			Gepr.		
Anderung	Datum	Name	Urspr		Ersatz von



Frontansicht
CPU 313SC,
313-5BF23

		=
		+ 313_5BF23
	Blatt	4
	Blatt	387

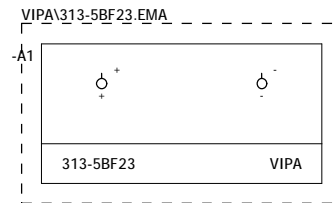
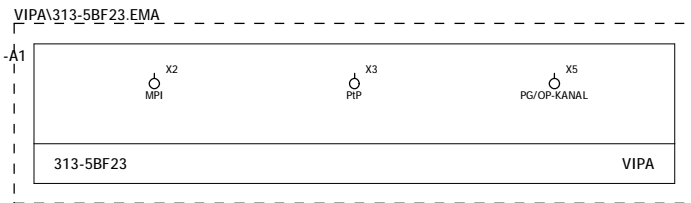

			Datum	19.12.2016	Produktmakros System 300S
			Bearb.	Winkler	
			Gepr.		
Anderung	Datum	Name	Urspr		Ersatz von



Anschlußbelegung
CPU 313SC,
313-5BF23

		=
		+ 313_5BF23
		Blatt 5
		Blatt 387

VIPA\313-5BF23.EMA

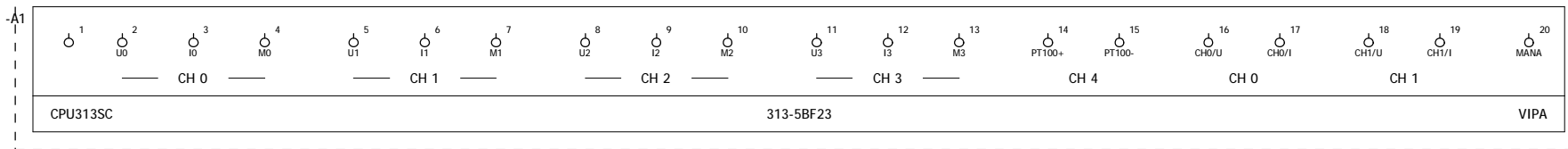

			Datum	19.12.2016	Produktmakros System 300S	YASKAWA	Analoge Ein-/Ausgänge CPU 313SC, 313-5BF23		=	+ 313_5BF23	Blatt	6
			Bearb.	Winkler								
			Gepr.									
Anderung	Datum	Name	Urspr		Ersatz von						Blatt	387

VIPA\313-5BF23.EMA

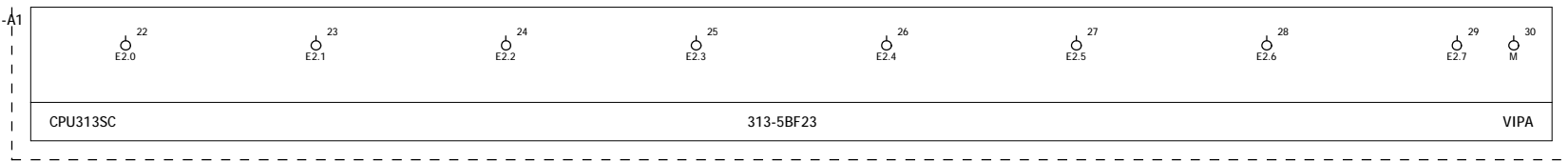

			Datum	19.12.2016	Produktmakros System 300S	YASKAWA	Eingangsbyte 2 CPU 313SC, 313-5BF23	=	+ 313_5BF23	Blatt 7
			Bearb.	Winkler						
			Gepr							
Anderung	Datum	Name	Urspr		Ersatz von					Blatt 387

VIPA\313-5BF23.EMA

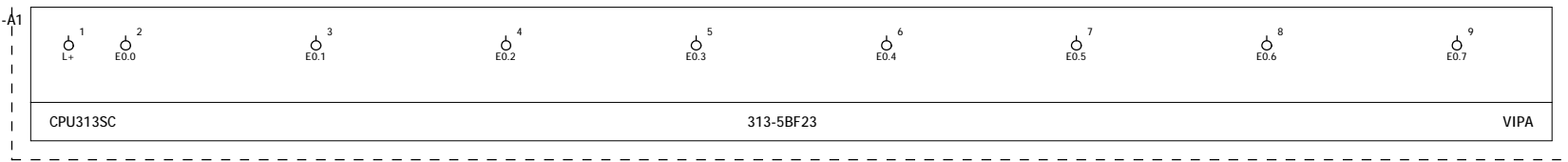

			Datum	19.12.2016	Produktmakros System 300S	YASKAWA	Eingangsbyte 0 CPU 313SC, 313-5BF23	=	+ 313_5BF23	Blatt	8
			Bearb.	Winkler							
			Gepr								
Anderung	Datum	Name	Urspr		Ersatz von					Blatt	387

VIPA\313-5BF23.EMA

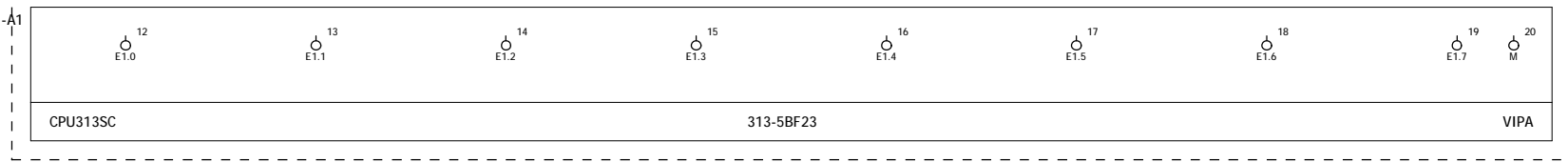

			Datum	19.12.2016	Produktmakros System 300S	YASKAWA	Eingangsbyte 1 CPU 313SC, 313-5BF23	=	+ 313_5BF23	Blatt	9
			Bearb.	Winkler							
			Gepr								
Anderung	Datum	Name	Urspr		Ersatz von					Blatt	387

VIPA\313-5BF23.EMA

A1

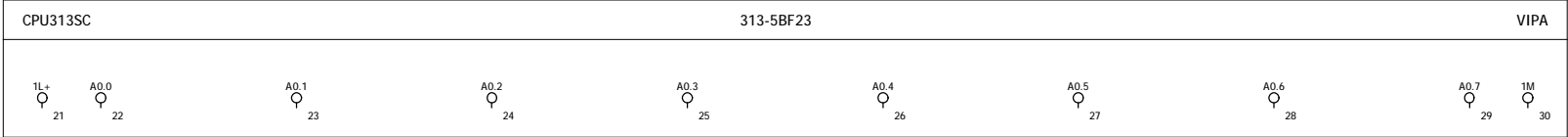

			Datum	19.12.2016	Produktmakros System 300S	YASKAWA	Ausgangsbyte 0 CPU 313SC, 313-5BF23	=	+ 313_5BF23	Blatt 10
			Bearb.	Winkler						
			Gepr							
Anderung	Datum	Name	Urspr		Ersatz von					Blatt 387

VIPA\313-5BF23.EMA

A1

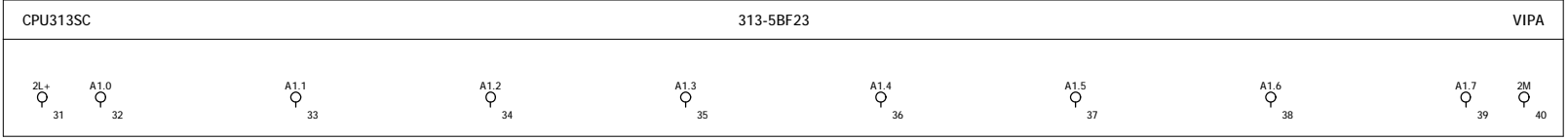

			Datum	19.12.2016	Produktmakros System 300S	YASKAWA	Ausgangsbyte 1 CPU 313SC, 313-5BF23	=	+ 313_5BF23	Blatt	11
			Bearb.	Winkler						Blatt	387
			Gepr								
Anderung	Datum	Name	Urspr		Ersatz von						

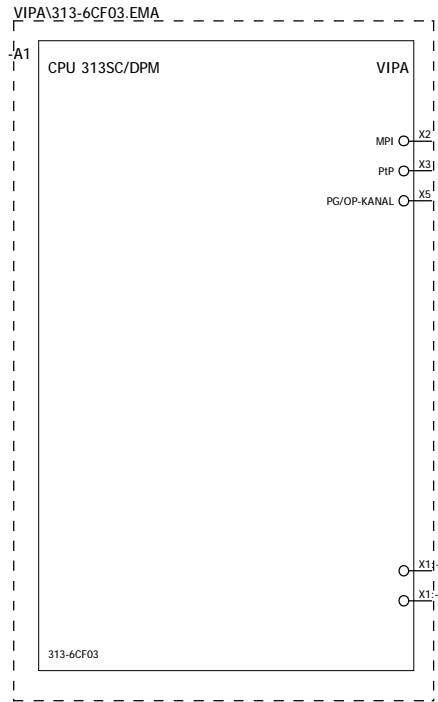

+313_5BF23/11

2

			Datum	08.05.2014	Produktmakros System 300S
			Bearb.	Winkler	
			Gepr		
Anderung	Datum	Name	Urspr		Ersatz von



SPS-Übersicht
CPU 313SC/DPM,
313-6CF03

=
+ 313_6CF03

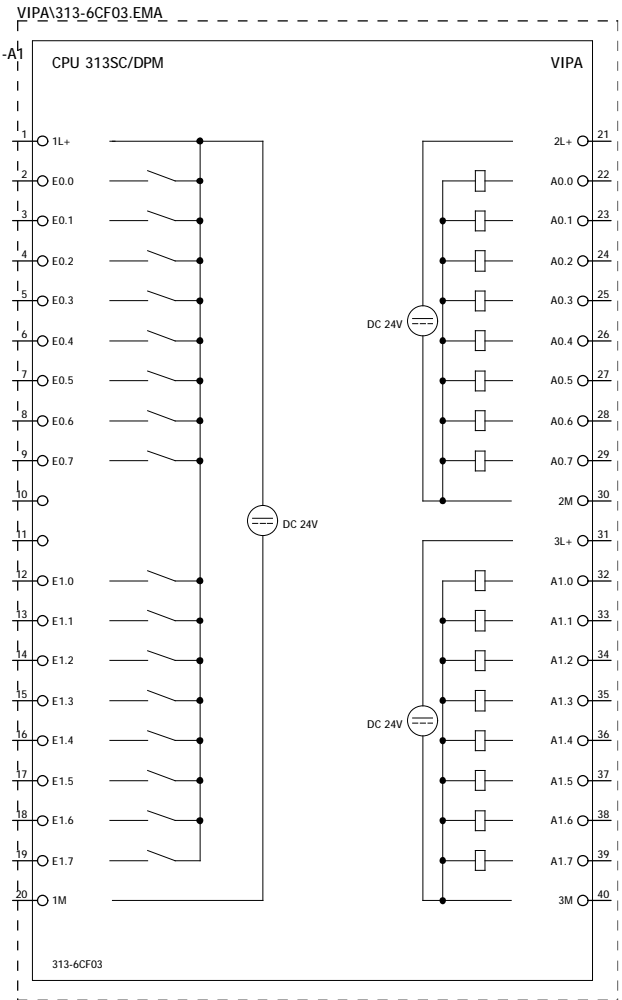

			Datum	08.05.2014	Produktmakros System 300S
			Bearb.	Winkler	
			Gepr.		
Anderung	Datum	Name	Urspr.		Ersatz von



SPS-Übersicht E/A-Bereich
CPU 313SC/DPM,
313-6CF03

		=
		+ 313_6CF03
		Blatt 2
		Blatt 387

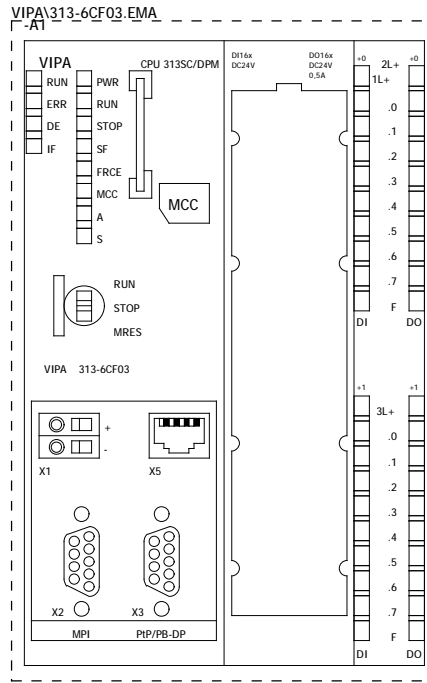

			Datum	29.11.2010	Produktmakros System 300S
			Bearb.	Winkler	
			Gepr.		
Anderung	Datum	Name	Urspr		Ersatz von



Frontansicht
CPU 313SC/DPM,
313-6CF03

		=
		+ 313_6CF03
		Blatt 3
		Blatt 387

VIPA\313-6CF03.EMA

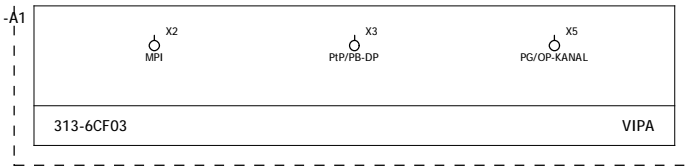

VIPA\313-6CF03.EMA

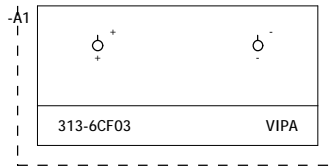

			Datum	08.05.2014	Produktmakros System 300S
			Bearb.	Winkler	
			Gepr		
Anderung	Datum	Name	Urspr		Ersatz von



Anschlußbelegung
CPU 313SC/DPM,
313-6CF03

		=
		+ 313_6CF03
		Blatt 4
		Blatt 387

VIPA\313-6CF03.EMA

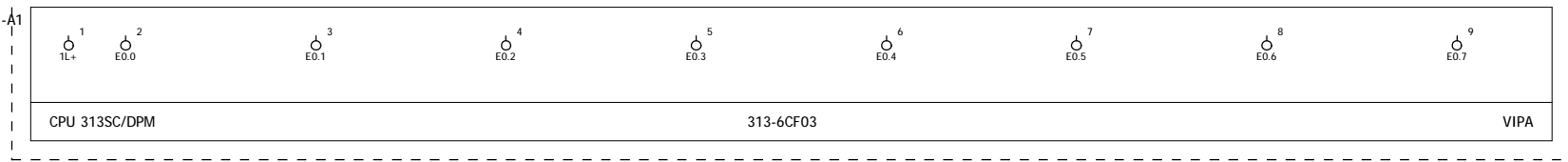

			Datum	08.05.2014	Produktmakros System 300S	YASKAWA	Eingangsbyte 0 CPU 313SC/DPM, 313-6CF03	=	+ 313_6CF03	Blatt	5
			Bearb.	Winkler							
			Gepr								
Anderung	Datum	Name	Urspr		Ersatz von					Blatt	387

VIPA\313-6CF03.EMA

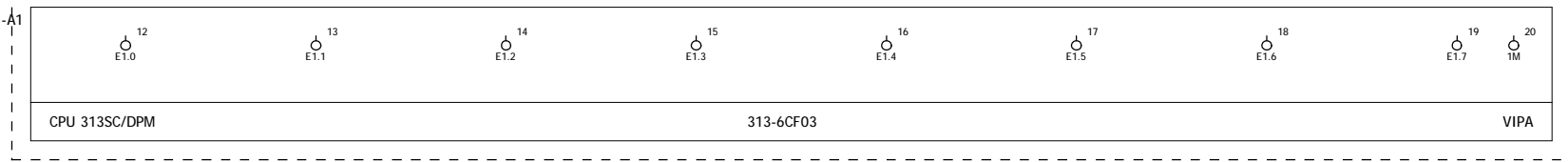

			Datum	08.05.2014	Produktmakros System 300S	YASKAWA	Eingangsbyte 1 CPU 313SC/DPM, 313-6CF03		=	+ 313_6CF03	Blatt 6
			Bearb.	Winkler							
			Gepr								
Anderung	Datum	Name	Urspr		Ersatz von						Blatt 387

VIPA\313-6CF03.EMA

A1

CPU 313SC/DPM

313-6CF03

VIPA



			Datum	08.05.2014	Produktmakros System 300S	YASKAWA	Ausgangsbyte 0 CPU 313SC/DPM, 313-6CF03	=	+ 313_6CF03	Blatt 7
			Bearb.	Winkler						
			Gepr							
Anderung	Datum	Name	Urspr		Ersatz von					Blatt 387

VIPA\313-6CF03.EMA

A1



7

+313_6CF13/1

			Datum	08.05.2014	Produktmakros System 300S	YASKAWA	Ausgangsbyte 1 CPU 313SC/DPM, 313-6CF03		=	+ 313_6CF03	Blatt 8
			Bearb.	Winkler							
			Gepr								
Anderung	Datum	Name	Urspr		Ersatz von						Blatt 387

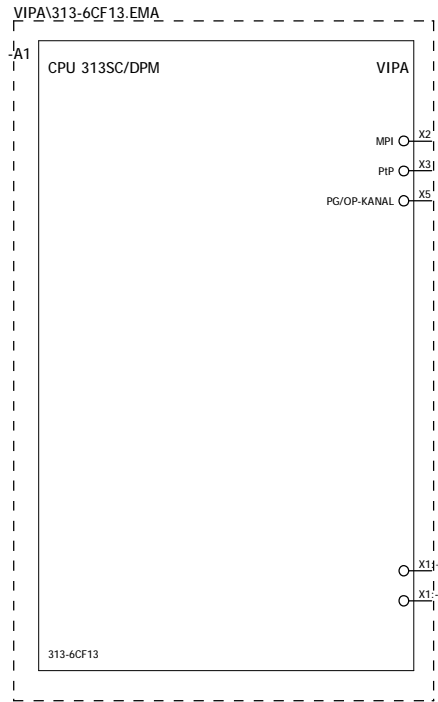

+313_6CF03/8

2

			Datum	08.05.2014	Produktmakros System 300S
			Bearb.	Winkler	
			Gepr		
Anderung	Datum	Name	Urspr		Ersatz von



SPS-Übersicht
CPU 313SC/DPM,
313-6CF13

=
+ 313_6CF13

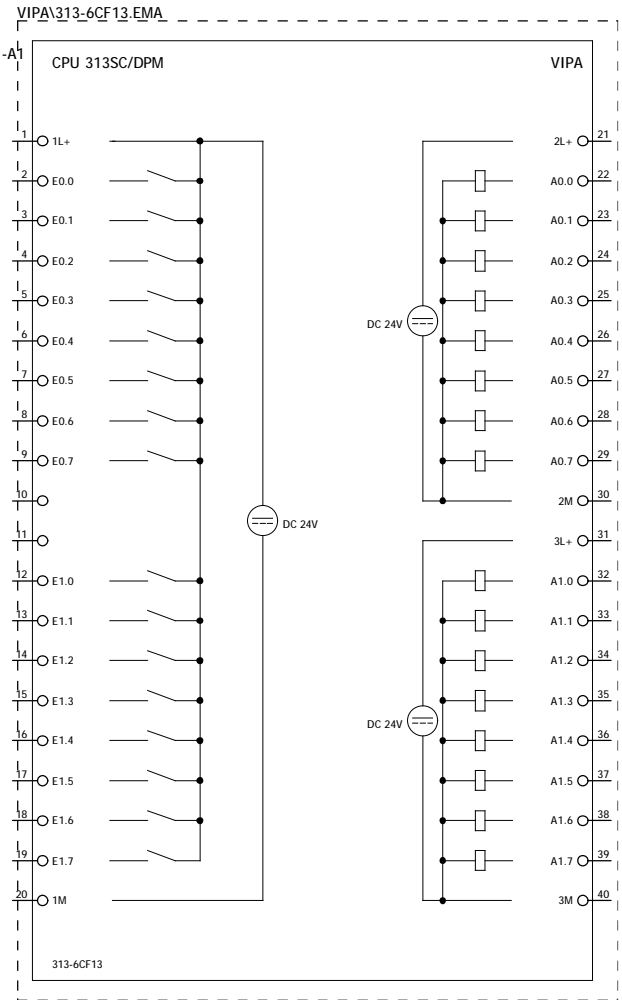

			Datum	08.05.2014	Produktmakros System 300S
			Bearb.	Winkler	
			Gepr.		
Anderung	Datum	Name	Urspr.		Ersatz von



SPS-Übersicht E/A-Bereich
CPU 313SC/DPM,
313-6CF13

		=
		+ 313_6CF13
		Blatt 2
		Blatt 387

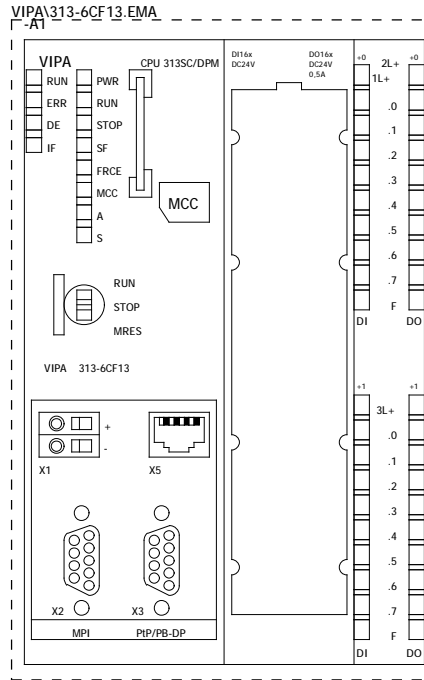

			Datum	29.10.2011	Produktmakros System 300S
			Bearb.	Winkler	
			Gepr.		
Anderung	Datum	Name	Urspr		Ersatz von



Frontansicht
CPU 313SC/DPM,
313-6CF13

		=
		+ 313_6CF13
		Blatt 3
		Blatt 387

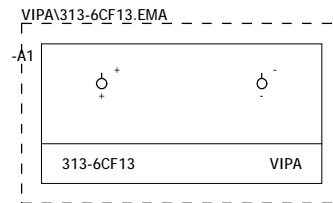
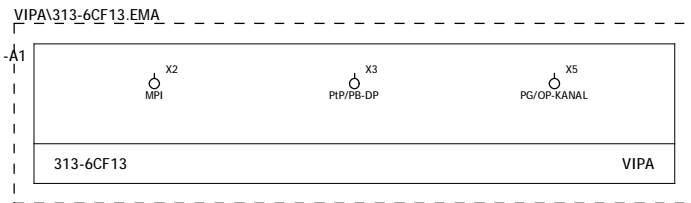

			Datum	08.05.2014	Produktmakros System 300S
			Bearb.	Winkler	
			Gepr		
Anderung	Datum	Name	Urspr		Ersatz von



Anschlußbelegung
CPU 313SC/DPM,
313-6CF13

		=
		+ 313_6CF13
		Blatt 4
		Blatt 387

VIPA\313-6CF13.EMA

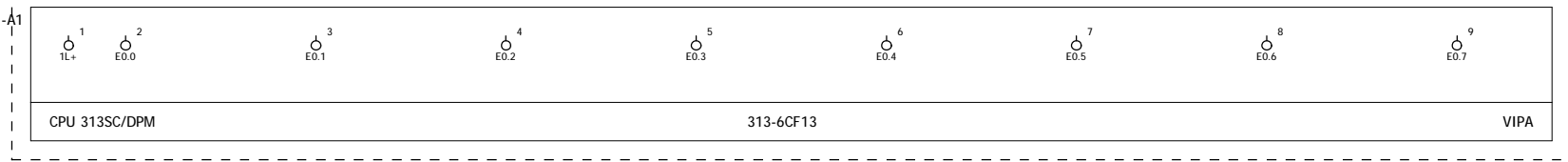

			Datum	08.05.2014	Produktmakros System 300S	YASKAWA	Eingangsbyte 0 CPU 313SC/DPM, 313-6CF13	=	+ 313_6CF13	Blatt	5
			Bearb.	Winkler							
			Gepr								
Anderung	Datum	Name	Urspr		Ersatz von					Blatt	387

VIPA\313-6CF13.EMA

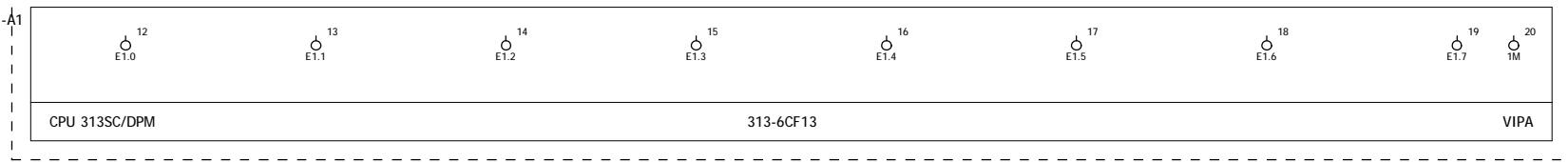

			Datum	08.05.2014	Produktmakros System 300S	YASKAWA	Eingangsbyte 1 CPU 313SC/DPM, 313-6CF13	=	+ 313_6CF13	Blatt 6
			Bearb.	Winkler						
			Gepr							
Anderung	Datum	Name	Urspr		Ersatz von					Blatt 387

VIPA\313-6CF13.EMA

A1

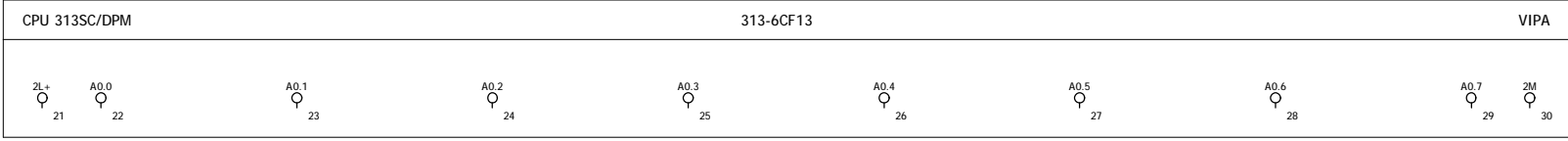

			Datum	08.05.2014	Produktmakros System 300S	YASKAWA	Ausgangsbyte 0 CPU 313SC/DPM, 313-6CF13	=	+ 313_6CF13	Blatt 7
			Bearb.	Winkler						
			Gepr							
Anderung	Datum	Name	Urspr		Ersatz von					Blatt 387

VIPA\313-6CF13.EMA

A1

CPU 313SC/DPM

313-6CF13

VIPA

3L+
31

A1.0
32

A1.1
33

A1.2
34

A1.3
35

A1.4
36

A1.5
37

A1.6
38

A1.7
39

3M
40

	Datum	08.05.2014	Produktmakros System 300S	
	Bearb.	Winkler		
	Gepr			
Anderung	Datum	Name	Urspr	Ersatz von



Ausgangsbyte 1
CPU 313SC/DPM,
313-6CF13

=	
+ 313_6CF13	
Blatt	8
Blatt	387

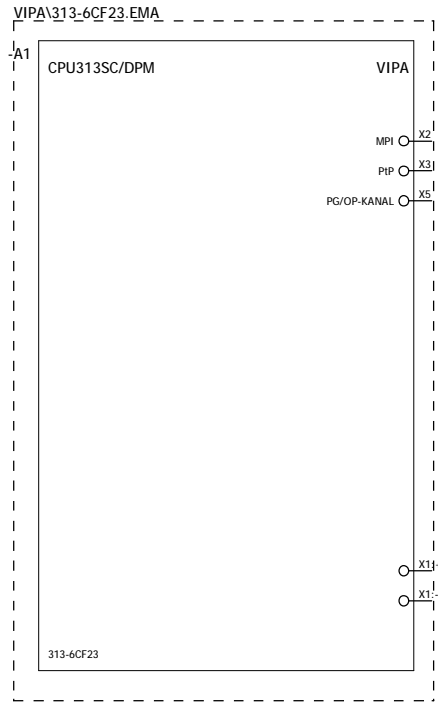

+313_6CF13/8

2

			Datum	19.12.2016	Produktmakros System 300S
			Bearb.	Winkler	
			Gepr		
Anderung	Datum	Name	Urspr		Ersatz von



SPS-Übersicht
CPU 313SC/DPM,
313-6CF23

=
+ 313_6CF23

VIPA\313-6CF23.EMA

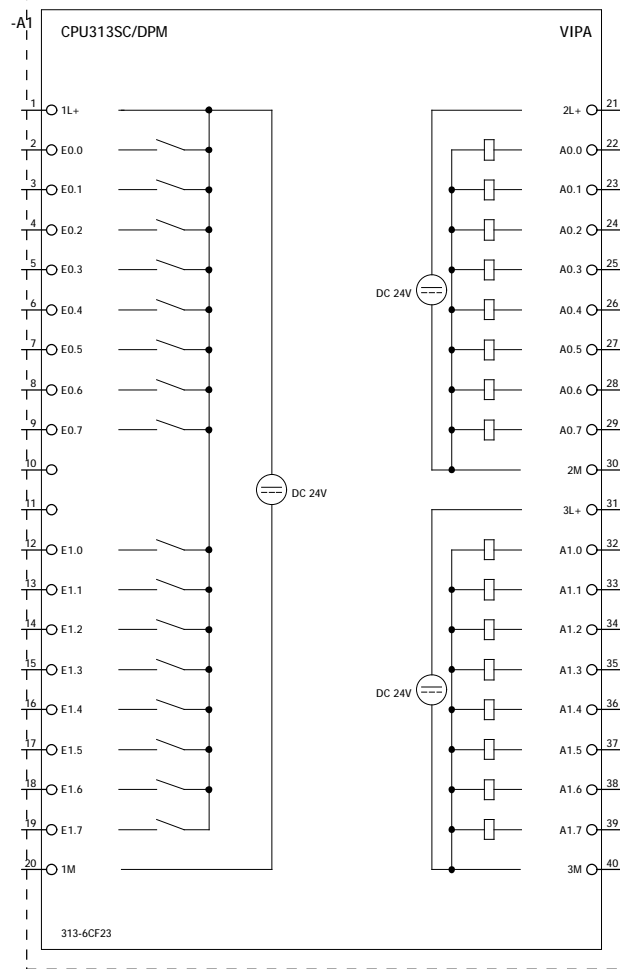

			Datum	19.12.2016	Produktmakros System 300S
			Bearb.	Winkler	
			Gepr.		
Anderung	Datum	Name	Urspr.		Ersatz von



SPS-Übersicht E/A-Bereich
CPU 313SC/DPM,
313-6CF23

		=
		+ 313_6CF23
		Blatt 2
		Blatt 387

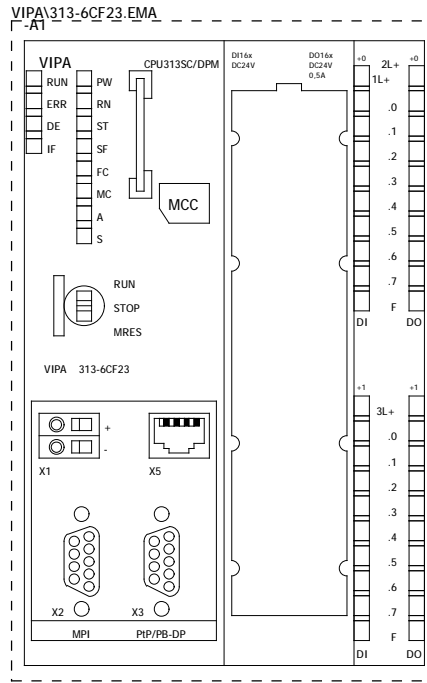

			Datum	20.12.2016	Produktmakros System 300S
			Bearb.	Winkler	
			Gepr.		
Anderung	Datum	Name	Urspr		Ersatz von



Frontansicht
CPU 313SC/DPM,
313-6CF23

		=
		+ 313_6CF23
		Blatt 3
		Blatt 387

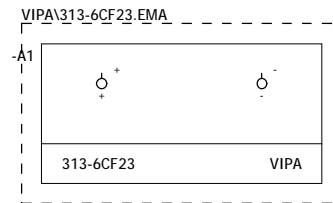
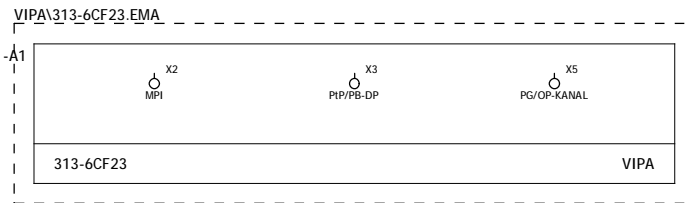

			Datum	19.12.2016	Produktmakros System 300S
			Bearb.	Winkler	
			Gepr.		
Anderung	Datum	Name	Urspr		Ersatz von



Anschlußbelegung
CPU 313SC/DPM,
313-6CF23

		=
		+ 313_6CF23
		Blatt 4
		Blatt 387

VIPA\313-6CF23.EMA

A1

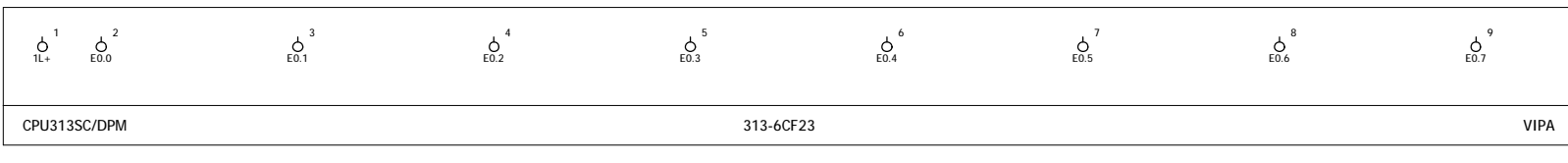

			Datum	19.12.2016	Produktmakros System 300S	YASKAWA	Eingangsbyte 0 CPU 313SC/DPM, 313-6CF23	=	+ 313_6CF23	Blatt	5
			Bearb.	Winkler							
			Gepr								
Anderung	Datum	Name	Urspr		Ersatz von					Blatt	387

VIPA\313-6CF23.EMA

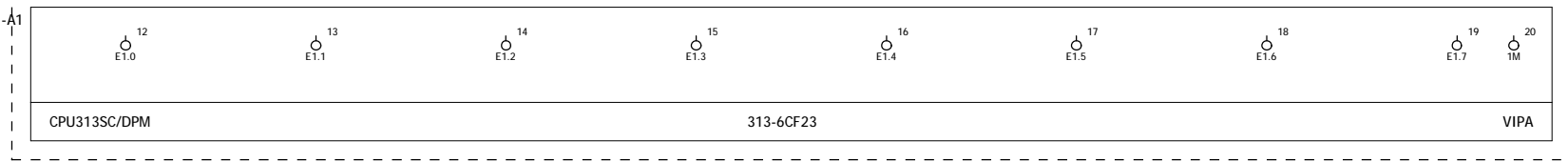

			Datum	19.12.2016	Produktmakros System 300S	YASKAWA	Eingangsbyte 1 CPU 313SC/DPM, 313-6CF23		=	+ 313_6CF23	Blatt 6
			Bearb.	Winkler							
			Gepr								
Anderung	Datum	Name	Urspr		Ersatz von						Blatt 387

VIPA\313-6CF23.EMA

A1

CPU313SC/DPM

313-6CF23

VIPA

2L+
21

A0.0
22

A0.1
23

A0.2
24

A0.3
25

A0.4
26

A0.5
27

A0.6
28

A0.7
29

2M
30

			Datum	19.12.2016	Produktmakros System 300S
			Bearb.	Winkler	
			Gepr		
Anderung	Datum	Name	Urspr		Ersatz von



Ausgangsbyte 0
CPU 313SC/DPM,
313-6CF23

		=	
		+ 313_6CF23	
			Blatt 7
			Blatt 387

VIPA\313-6CF23.EMA

A1

CPU313SC/DPM

313-6CF23

VIPA

3L+
31

A1.0
32

A1.1
33

A1.2
34

A1.3
35

A1.4
36

A1.5
37

A1.6
38

A1.7
39

3M
40

7

+314_2AG12/1

			Datum	19.12.2016	Produktmakros System 300S
			Bearb.	Winkler	
			Gepr		
Anderung	Datum	Name	Urspr		Ersatz von



Ausgangsbyte 1
CPU 313SC/DPM,
313-6CF23

=
+ 313_6CF23

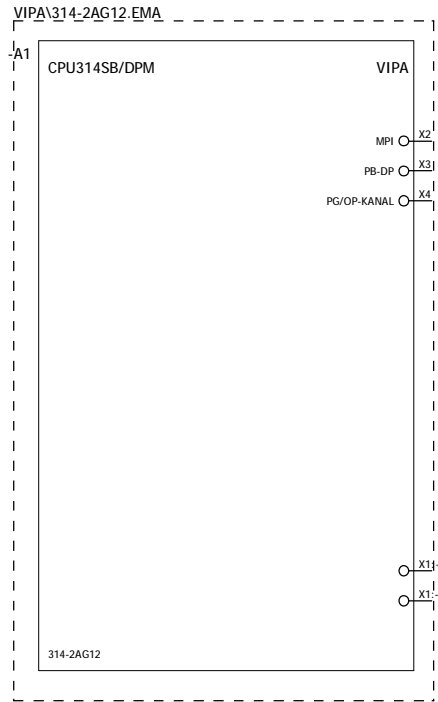

+313_6CF23/8

			Datum	08.05.2014	Produktmakros System 300S	YASKAWA	SPS-Übersicht CPU 314SB/DPM, 314-2AG12		=	+ 314_2AG12	Blatt	1
			Bearb.	Winkler								
			Gepr									
Anderung	Datum	Name	Urspr		Ersatz von						Blatt	387

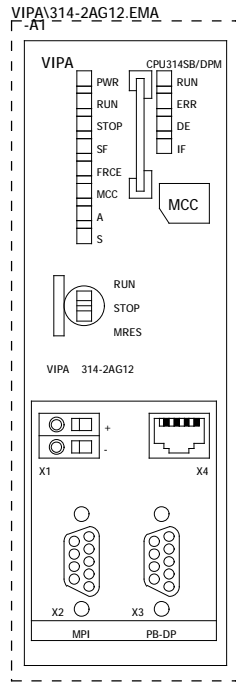

			Datum	29.10.2011	Produktmakros System 300S
			Bearb.	Winkler	
			Gepr.		
Anderung	Datum	Name	Urspr		Ersatz von



Frontansicht
CPU 314SB/DPM,
314-2AG12

		=
		+ 314_2AG12
		Blatt 2
		Blatt 387

VIPA\314-2AG12.EMA

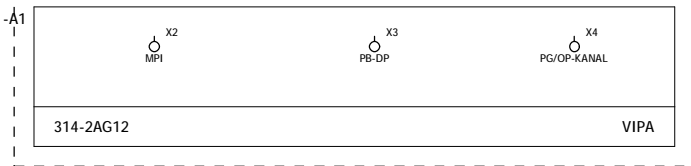

VIPA\314-2AG12.EMA

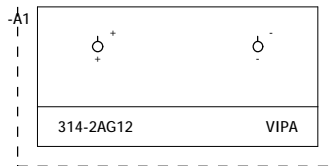

			Datum	08.05.2014	Produktmakros System 300S
			Bearb.	Winkler	
			Gepr.		
Anderung	Datum	Name	Urspr.		Ersatz von



Anschlußbelegung
CPU 314SB/DPM,
314-2AG12

		=
		+ 314_2AG12
		Blatt 3
		Blatt 387

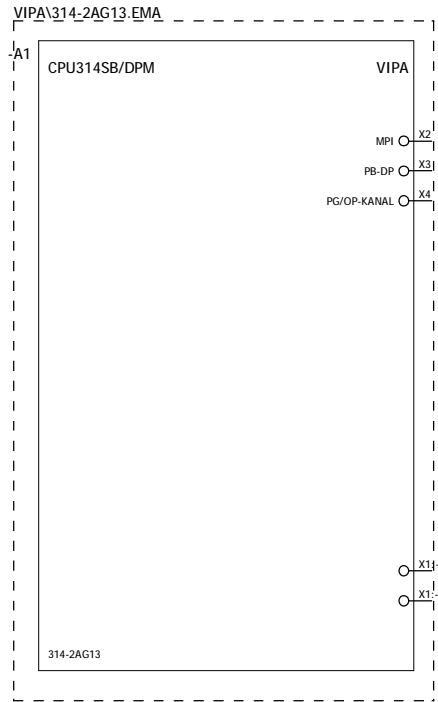

+314_2AG12/3

2

			Datum	08.05.2014	Produktmakros System 300S
			Bearb.	Winkler	
			Gepr		
Anderung	Datum	Name	Urspr		Ersatz von



SPS-Übersicht
CPU 314SB/DPM,
314-2AG13

		=
		+ 314_2AG13
		Blatt 1
		Blatt 387

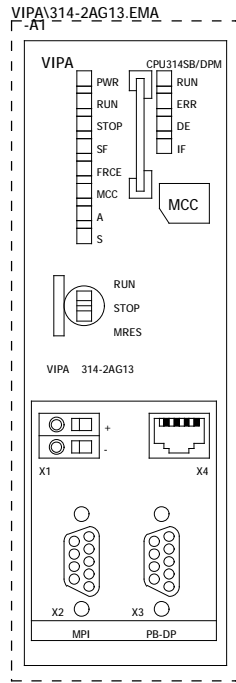

			Datum	08.05.2014	Produktmakros System 300S
			Bearb.	Winkler	
			Gepr.		
Anderung	Datum	Name	Urspr		Ersatz von



Frontansicht
CPU 314SB/DPM,
314-2AG13

		=
		+ 314_2AG13
		Blatt 2
		Blatt 387

VIPA\314-2AG13.EMA

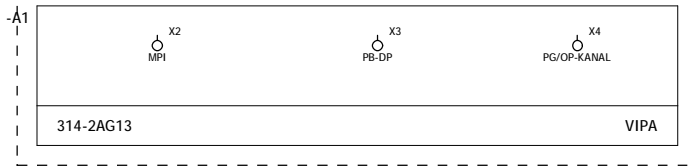

VIPA\314-2AG13.EMA

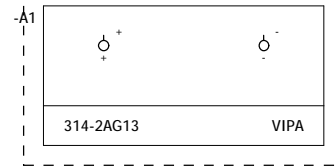

			Datum	08.05.2014	Produktmakros System 300S
			Bearb.	Winkler	
			Gepr.		
Anderung	Datum	Name	Urspr.		Ersatz von



Anschlußbelegung
CPU 314SB/DPM,
314-2AG13

		=	
		+ 314_2AG13	
			Blatt 3
			Blatt 387

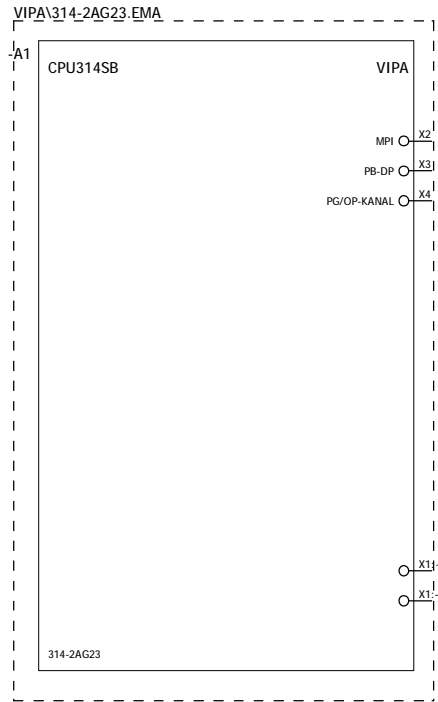

+314_2AG13/3

2

			Datum	19.12.2016	Produktmakros System 300S
			Bearb.	Winkler	
			Gepr		
Anderung	Datum	Name	Urspr		Ersatz von



SPS-Übersicht
CPU 314SB/DPM,
314-2AG23

		=
		+ 314_2AG23
		Blatt 1
		Blatt 387

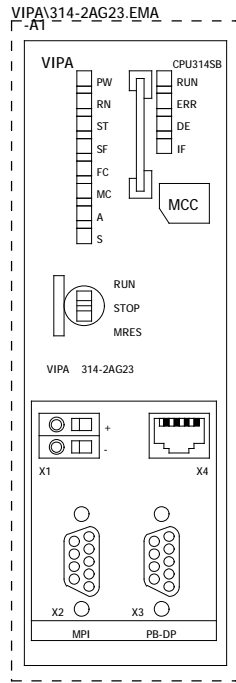

			Datum	20.12.2016	Produktmakros System 300S
			Bearb.	Winkler	
			Gepr		
Anderung	Datum	Name	Urspr		Ersatz von



Frontansicht
CPU 314SB/DPM,
314-2AG23

		=
		+ 314_2AG23
		Blatt 2
		Blatt 387

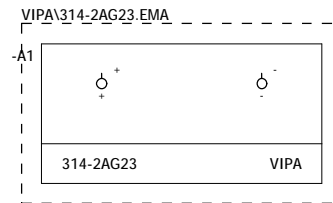
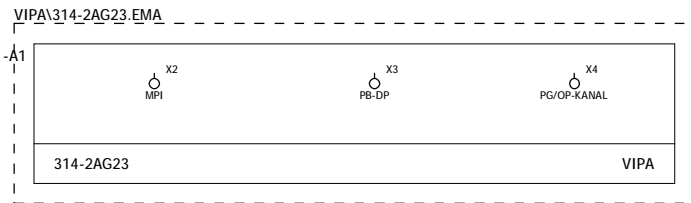

			Datum	19.12.2016	Produktmakros System 300S	YASKAWA	Anschlußbelegung CPU 314SB/DPM, 314-2AG23		=	+ 314_2AG23	Blatt	3
			Bearb.	Winkler							Blatt	387
			Gepr.									
Anderung	Datum	Name	Urspr		Ersatz von							

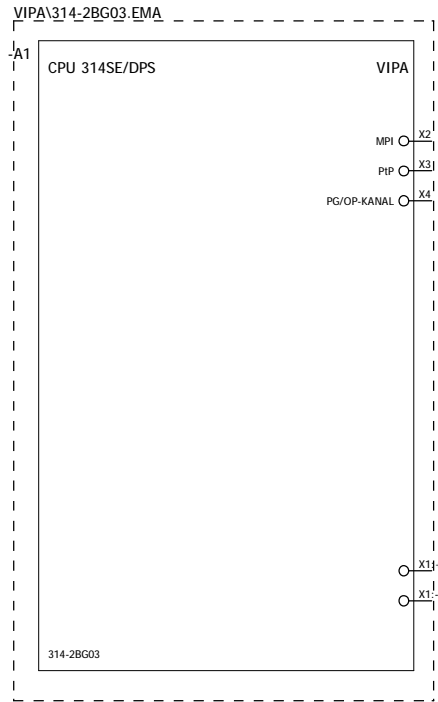

+314_2AG23/3

2

			Datum	08.05.2014	Produktmakros System 300S	YASKAWA	SPS-Übersicht CPU 314SE/DPS, 314-2BG03		=	+ 314_2BG03	Blatt 1
			Bearb.	Winkler							
			Gepr								
Anderung	Datum	Name	Urspr		Ersatz von						Blatt 387

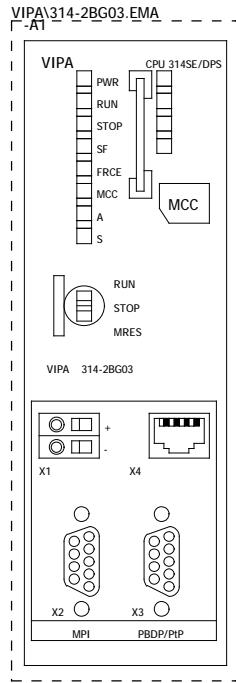

			Datum	29.11.2010	Produktmakros System 300S
			Bearb.	Winkler	
			Gepr		
Anderung	Datum	Name	Urspr		Ersatz von



Frontansicht
CPU 314SE/DPS,
314-2BG03

		=
		+ 314_2BG03
		Blatt 2
		Blatt 387

VIPA\314-2BG03.EMA

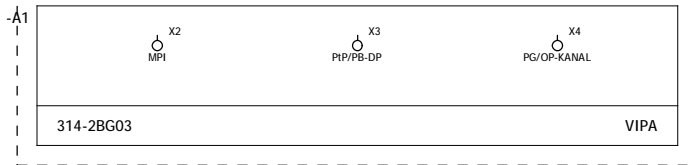

VIPA\314-2BG03.EMA

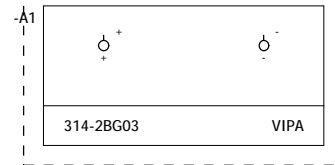

			Datum	08.05.2014	Produktmakros System 300S
			Bearb.	Winkler	
			Gepr.		
Anderung	Datum	Name	Urspr		Ersatz von



Anschlußbelegung
CPU 314SE/DPS,
314-2BG03

		=
		+ 314_2BG03
		Blatt 3
		Blatt 387

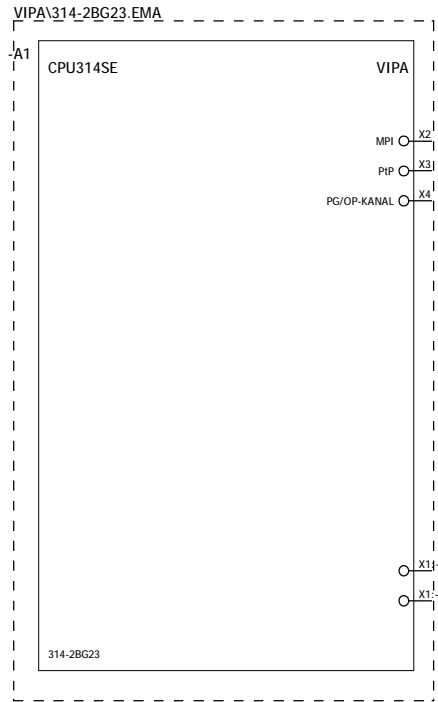

+314_2BG03/3

			Datum	19.12.2016	Produktmakros System 300S	YASKAWA	SPS-Übersicht CPU 314SE, 314-2BG23		=	+ 314_2BG23	Blatt	1
			Bearb.	Winkler							Blatt	387
			Gepr									
Anderung	Datum	Name	Urspr		Ersatz von							

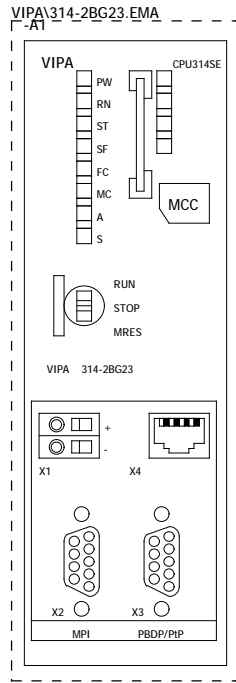

			Datum	20.12.2016	Produktmakros System 300S
			Bearb.	Winkler	
			Gepr		
Anderung	Datum	Name	Urspr		Ersatz von



Frontansicht
CPU 314SE,
314-2BG23

		=
		+ 314_2BG23
		Blatt 2
		Blatt 387

VIPA\314-2BG23.EMA

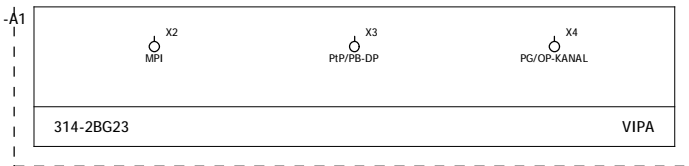

VIPA\314-2BG23.EMA

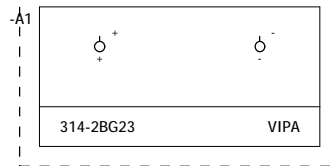

			Datum	19.12.2016	Produktmakros System 300S	YASKAWA	Anschlußbelegung CPU 314SE, 314-2BG23		=	+ 314_2BG23	Blatt	3
			Bearb.	Winkler							Blatt	387
			Gepr.									
Anderung	Datum	Name	Urspr		Ersatz von							

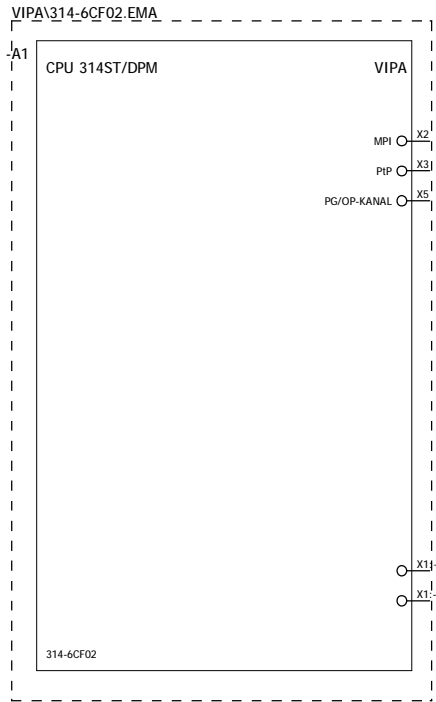

+314_2BG23/3

2

			Datum	08.05.2014	Produktmakros System 300S	YASKAWA	SPS-Übersicht CPU 314ST/DPM, 314-6CF02	=	+ 314_6CF02	Blatt	1
			Bearb.	Winkler							
			Gepr								
Anderung	Datum	Name	Urspr		Ersatz von					Blatt	387

VIPA\314-6CF02.EMA

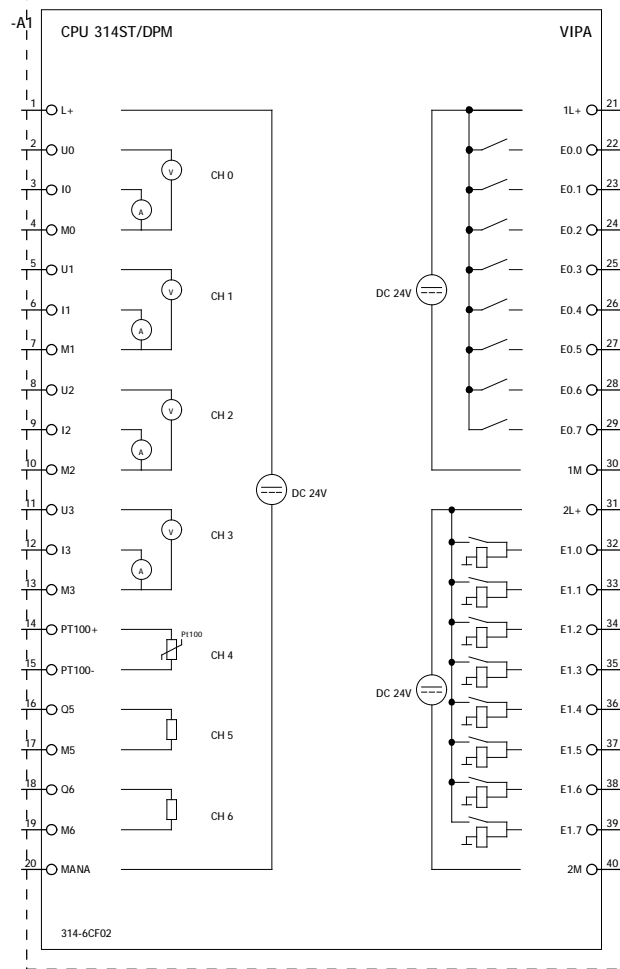

			Datum	08.05.2014	Produktmakros System 300S
			Bearb.	Winkler	
			Gepr.		
Anderung	Datum	Name	Urspr		Ersatz von



SPS-Übersicht E/A-Bereich
CPU 314ST/DPM,
314-6CF02

		=
		+ 314_6CF02
	Blatt	2
	Blatt	387

VIPA\314-6CF02.EMA

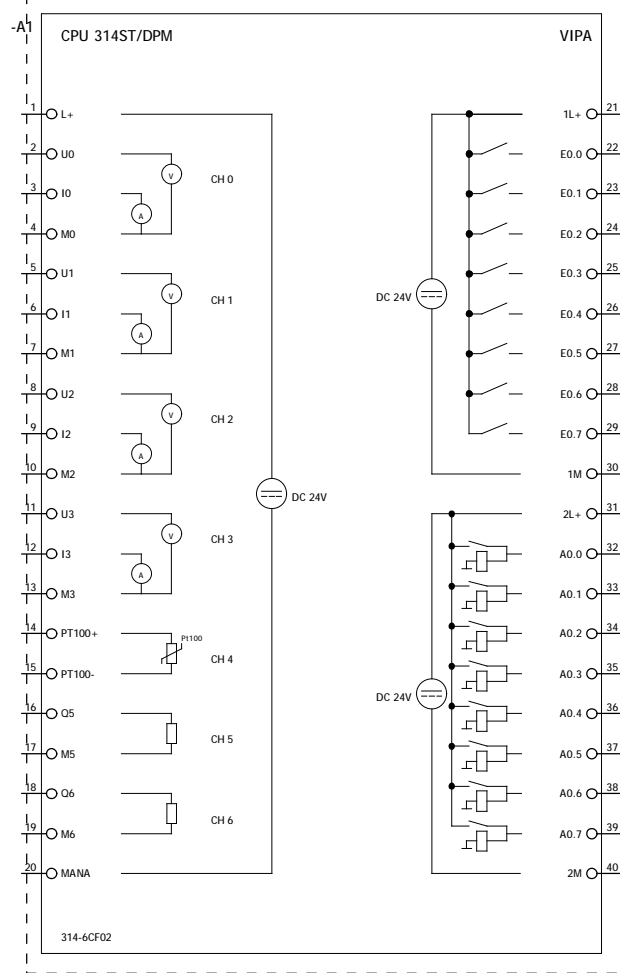

			Datum	08.05.2014	Produktmakros System 300S
			Bearb.	Winkler	
			Gepr.		
Anderung	Datum	Name	Urspr		Ersatz von



SPS-Übersicht E/A-Bereich
CPU 314ST/DPM,
314-6CF02

		=
		+ 314_6CF02
	Blatt	3
	Blatt	387

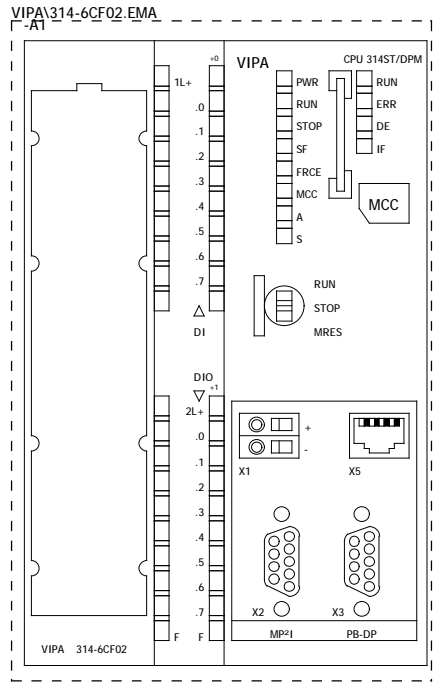

			Datum	29.11.2010	Produktmakros System 300S
			Bearb.	Winkler	
			Gepr.		
Anderung	Datum	Name	Urspr		Ersatz von



Frontansicht
CPU 314ST/DPM,
314-6CF02

		=
		+ 314_6CF02
		Blatt 4
		Blatt 387

VIPA\314-6CF02.EMA

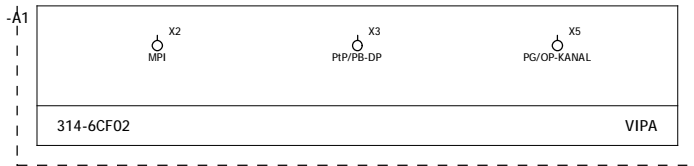

VIPA\314-6CF02.EMA

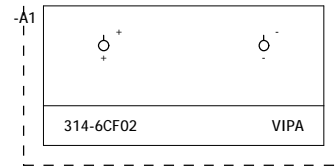

			Datum	08.05.2014	Produktmakros System 300S
			Bearb.	Winkler	
			Gepr.		
Anderung	Datum	Name	Urspr.		Ersatz von



Anschlußbelegung
CPU 314ST/DPM,
314-6CF02

		=
		+ 314_6CF02
		Blatt 5
		Blatt 387

VIPA\314-6CF02.EMA

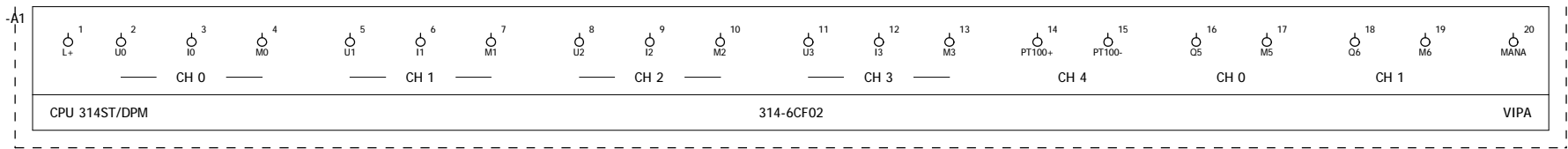

			Datum	08.05.2014	Produktmakros System 300S	YASKAWA	Analoge Ein-/Ausgänge CPU 314ST/DPM, 314-6CF02		=	+ 314_6CF02	Blatt	6
			Bearb.	Winkler								
			Gepr									
Anderung	Datum	Name	Urspr		Ersatz von						Blatt	387

VIPA\314-6CF02.EMA

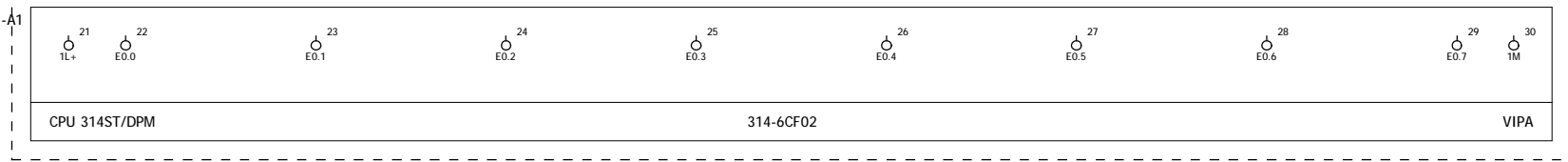

			Datum	08.05.2014	Produktmakros System 300S	YASKAWA	Eingangsbyte 0 CPU 314ST/DPM, 314-6CF02		=	+ 314_6CF02	Blatt 7
			Bearb.	Winkler							
			Gepr								
Anderung	Datum	Name	Urspr		Ersatz von						Blatt 387

VIPA\314-6CF02.EMA

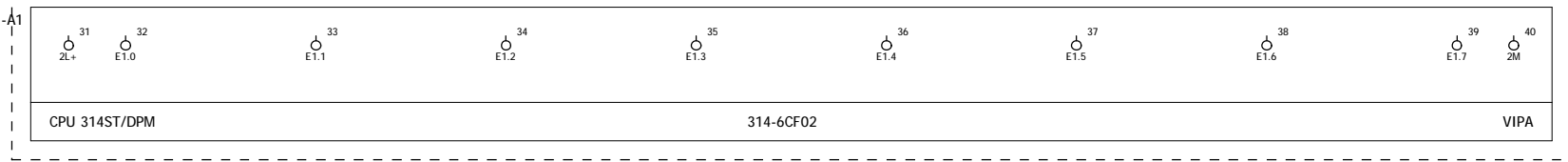

			Datum	08.05.2014	Produktmakros System 300S	YASKAWA	Eingangsbyte 1 CPU 314ST/DPM, 314-6CF02		=	+ 314_6CF02	Blatt 8
			Bearb.	Winkler							
			Gepr								
Anderung	Datum	Name	Urspr		Ersatz von						Blatt 387

VIPA\314-6CF02.EMA

A1

CPU 314ST/DPM

314-6CF02

VIPA



			Datum	08.05.2014	Produktmakros System 300S	YASKAWA	Ausgangsbyte 0 CPU 314ST/DPM, 314-6CF02		=	+ 314_6CF02	Blatt 9
			Bearb.	Winkler							
			Gepr								
Anderung	Datum	Name	Urspr		Ersatz von						Blatt 387

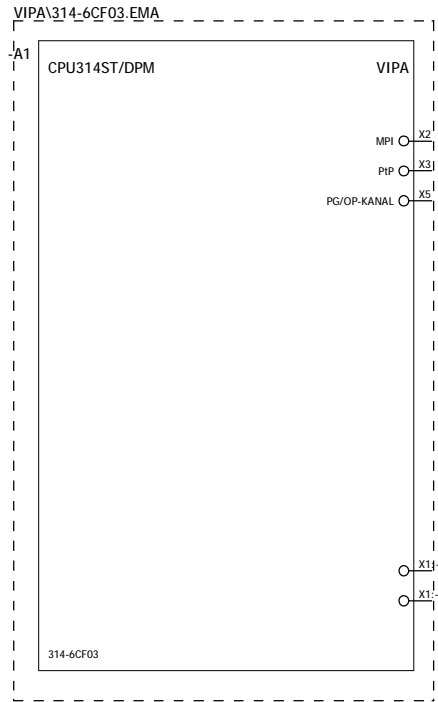

+314_6CF02/9

			Datum	08.05.2014	Produktmakros System 300S	YASKAWA	SPS-Übersicht CPU 314ST/DPM, 314-6CF03		=	+ 314_6CF03	Blatt	1
			Bearb.	Winkler							Blatt	387
			Gepr									
Anderung	Datum	Name	Urspr		Ersatz von							

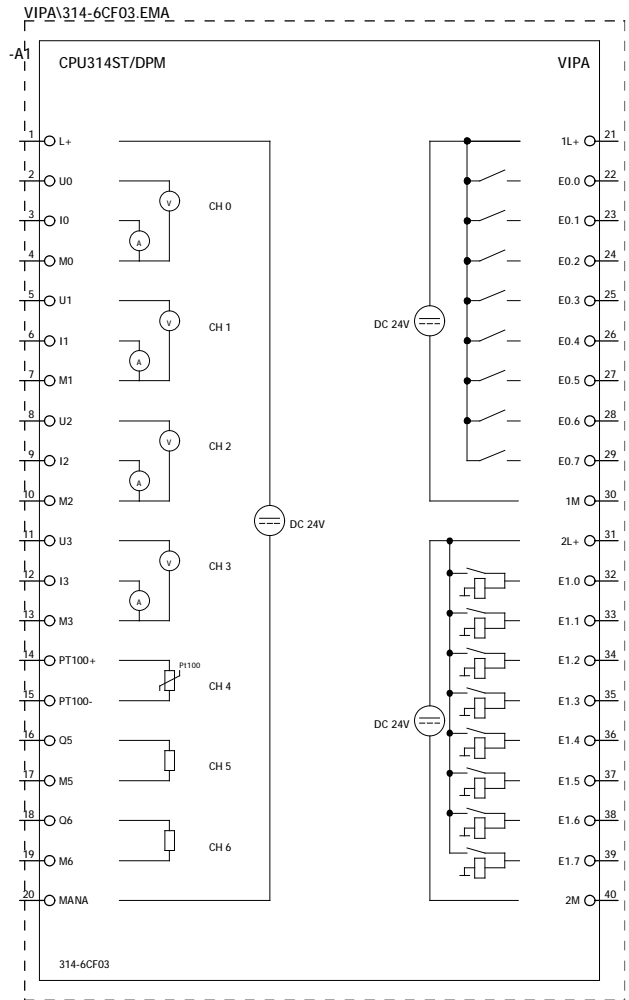

			Datum	08.05.2014	Produktmakros System 300S
			Bearb.	Winkler	
			Gepr.		
Anderung	Datum	Name	Urspr		Ersatz von



SPS-Übersicht E/A-Bereich
CPU 314ST/DPM,
314-6CF03

		=
		+ 314_6CF03
		Blatt 2
		Blatt 387

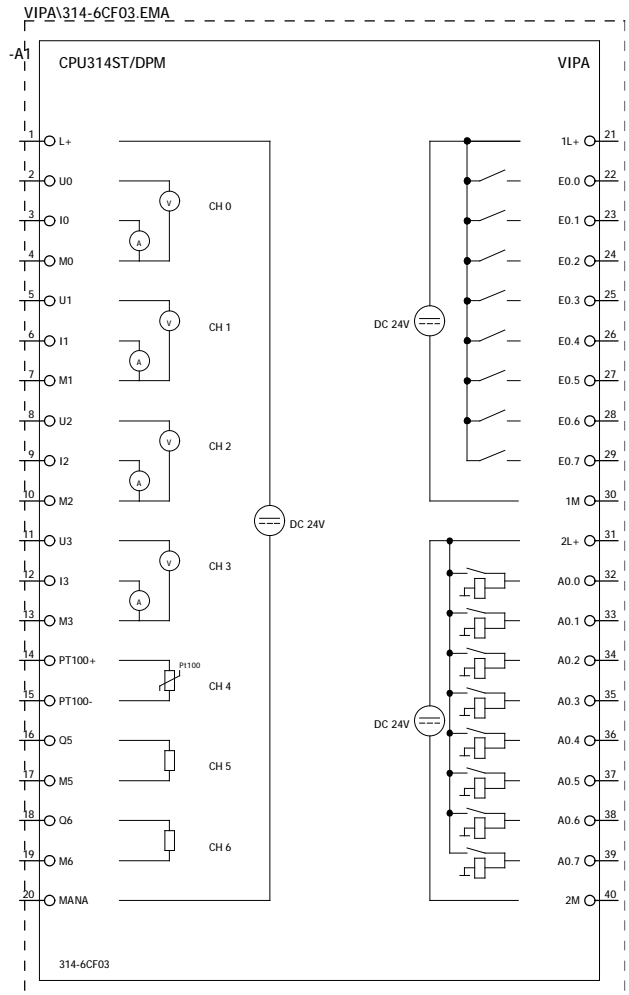

			Datum	08.05.2014	Produktmakros System 300S
			Bearb.	Winkler	
			Gepr.		
Anderung	Datum	Name	Urspr		Ersatz von



SPS-Übersicht E/A-Bereich
CPU 314ST/DPM,
314-6CF03

		=
		+ 314_6CF03
		Blatt 3
		Blatt 387

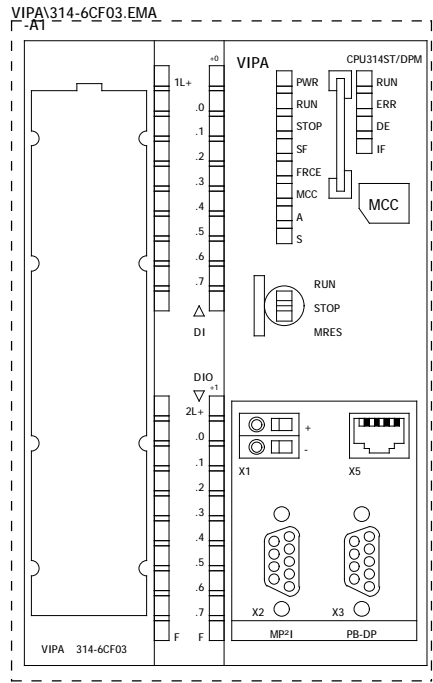

			Datum	08.05.2014	Produktmakros System 300S
			Bearb.	Winkler	
			Gepr.		
Anderung	Datum	Name	Urspr		Ersatz von



Frontansicht
CPU 314ST/DPM,
314-6CF03

		=
		+ 314_6CF03
		Blatt 4
		Blatt 387

VIPA\314-6CF03.EMA

-A1



VIPA\314-6CF03.EMA

-A1

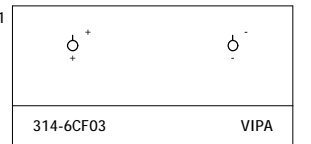

			Datum	08.05.2014	Produktmakros System 300S
			Bearb.	Winkler	
			Gepr.		
Anderung	Datum	Name	Urspr.		Ersatz von



Anschlußbelegung
CPU 314ST/DPM,
314-6CF03

		=	
		+ 314_6CF03	
			Blatt 5
			Blatt 387

VIPA\314-6CF03.EMA

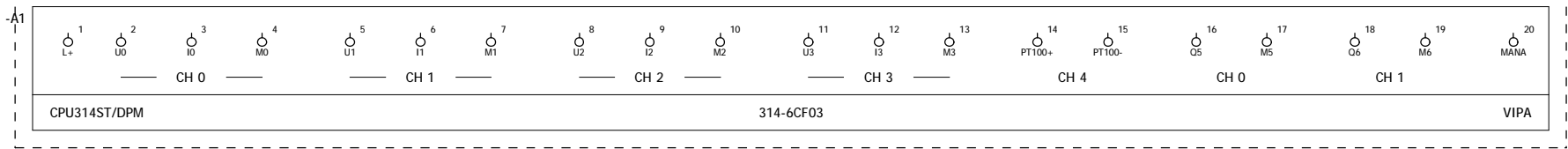

			Datum	08.05.2014	Produktmakros System 300S	YASKAWA	Analoge Ein-/Ausgänge CPU 314ST/DPM, 314-6CF03		=	+ 314_6CF03	Blatt 6
			Bearb.	Winkler							
			Gepr.								
Anderung	Datum	Name	Urspr		Ersatz von						Blatt 387

VIPA\314-6CF03.EMA

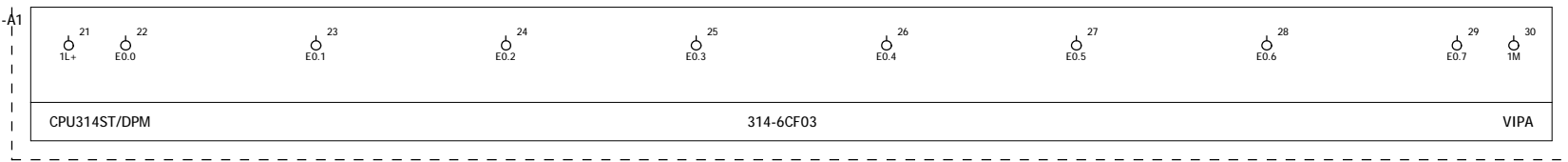

			Datum	08.05.2014	Produktmakros System 300S	YASKAWA	Eingangsbyte 0 CPU 314ST/DPM, 314-6CF03		=	+ 314_6CF03	Blatt 7
			Bearb.	Winkler							
			Gepr								
Anderung	Datum	Name	Urspr		Ersatz von						Blatt 387

VIPA\314-6CF03.EMA

A1

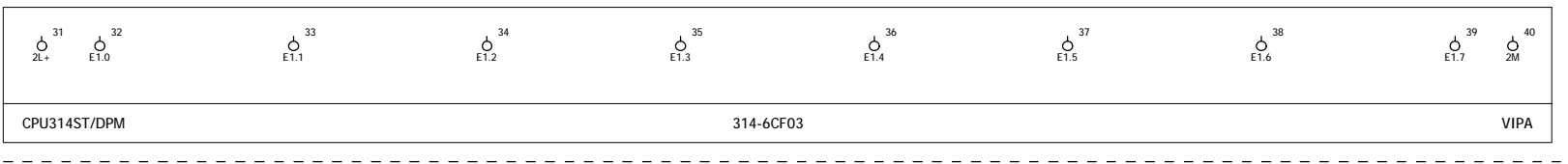

			Datum	08.05.2014	Produktmakros System 300S	YASKAWA	Eingangsbyte 1 CPU 314ST/DPM, 314-6CF03		=	+ 314_6CF03	Blatt 8
			Bearb.	Winkler							
			Gepr								
Anderung	Datum	Name	Urspr		Ersatz von						Blatt 387

VIPA\314-6CF03.EMA

A1

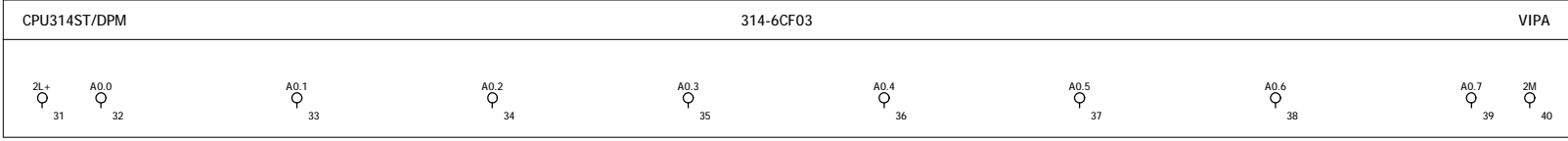

			Datum	08.05.2014	Produktmakros System 300S	YASKAWA	Ausgangsbyte 0 CPU 314ST/DPM, 314-6CF03		=	+ 314_6CF03	Blatt	9
			Bearb.	Winkler							Blatt	387
			Gepr									
Anderung	Datum	Name	Urspr		Ersatz von							

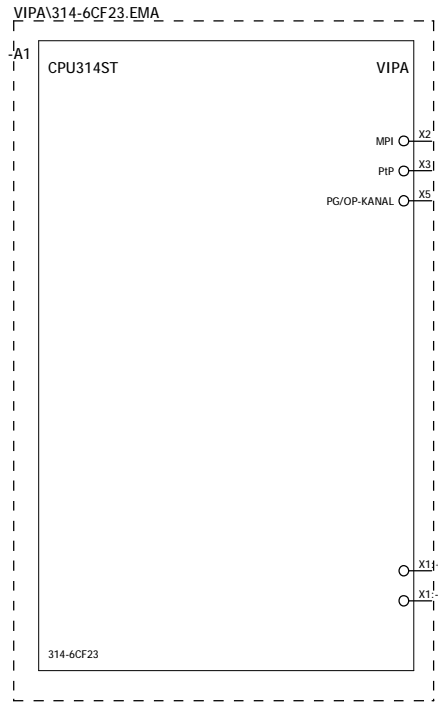

+314_6CF03/9

2

			Datum	19.12.2016	Produktmakros System 300S	YASKAWA	SPS-Übersicht CPU 314ST, 314-6CF23	=	+ 314_6CF23	Blatt	1
			Bearb.	Winkler							
			Gepr								
Anderung	Datum	Name	Urspr		Ersatz von					Blatt	387

VIPA\314-6CF23.EMA

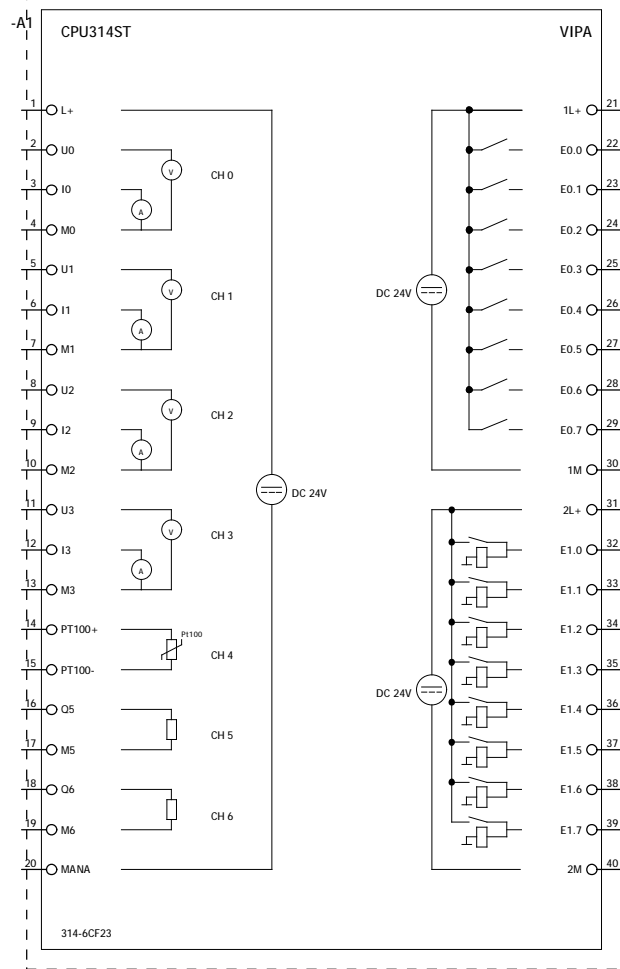

			Datum	19.12.2016	Produktmakros System 300S
			Bearb.	Winkler	
			Gepr.		
Anderung	Datum	Name	Urspr		Ersatz von



SPS-Übersicht E/A-Bereich
CPU 314ST,
314-6CF23

		=
		+ 314_6CF23
		Blatt 2
		Blatt 387

VIPA\314-6CF23.EMA

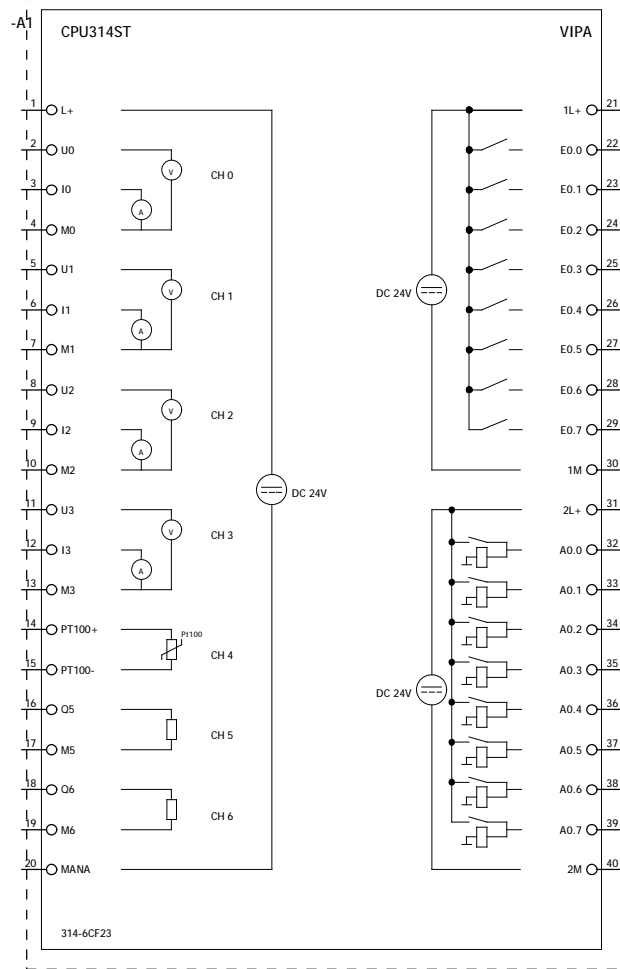

			Datum	19.12.2016	Produktmakros System 300S
			Bearb.	Winkler	
			Gepr.		
Anderung	Datum	Name	Urspr		Ersatz von



SPS-Übersicht E/A-Bereich
CPU 314ST,
314-6CF23

		=
		+ 314_6CF23
		Blatt 3
		Blatt 387

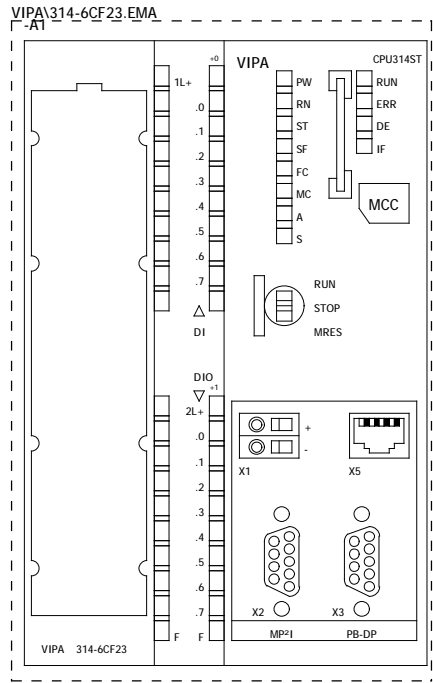

			Datum	20.12.2016	Produktmakros System 300S
			Bearb.	Winkler	
			Gepr.		
Anderung	Datum	Name	Urspr.		Ersatz von



Frontansicht
CPU 314ST,
314-6CF23

		=
		+ 314_6CF23
		Blatt 4
		Blatt 387

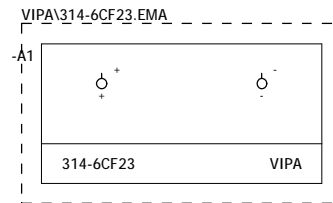
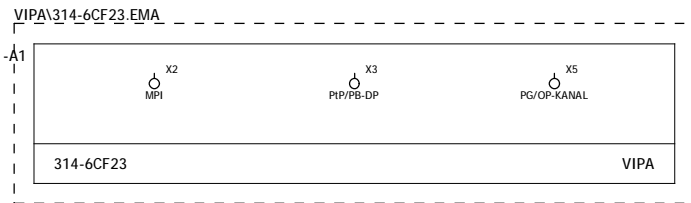

			Datum	19.12.2016	Produktmakros System 300S
			Bearb.	Winkler	
			Gepr.		
Anderung	Datum	Name	Urspr		Ersatz von



Anschlußbelegung
CPU 314ST,
314-6CF23

		=
		+ 314_6CF23
		Blatt 5
		Blatt 387

VIPA\314-6CF23.EMA

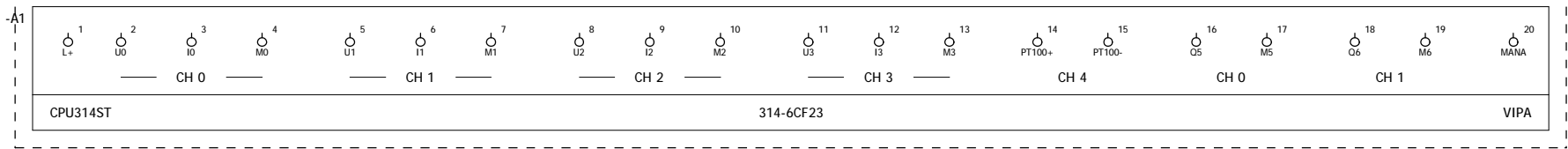

			Datum	19.12.2016	Produktmakros System 300S	YASKAWA	Analoge Ein-/Ausgänge CPU 314ST, 314-6CF23		=	+ 314_6CF23	Blatt	6
			Bearb.	Winkler								
			Gepr.									
Anderung	Datum	Name	Urspr.		Ersatz von						Blatt	387

VIPA\314-6CF23.EMA

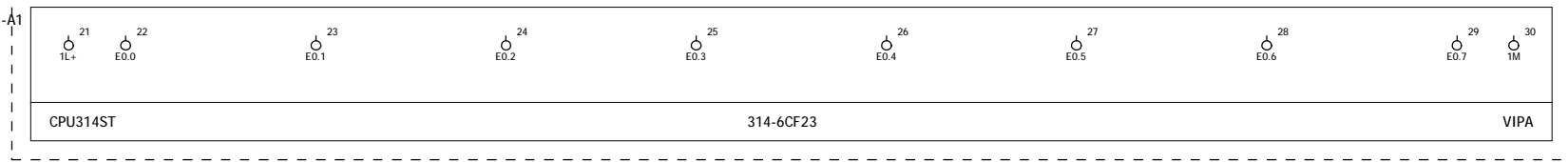

			Datum	19.12.2016	Produktmakros System 300S	YASKAWA	Eingangsbyte 0 CPU 314ST, 314-6CF23		=	+ 314_6CF23	Blatt 7
			Bearb.	Winkler							
			Gepr								
Anderung	Datum	Name	Urspr		Ersatz von						Blatt 387

VIPA\314-6CF23.EMA

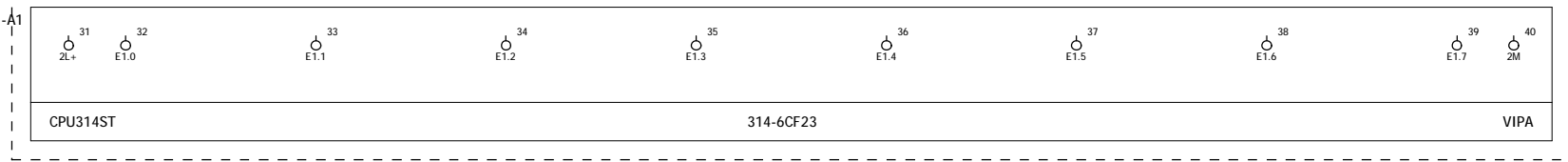

			Datum	19.12.2016	Produktmakros System 300S	YASKAWA	Eingangsbyte 1 CPU 314ST, 314-6CF23		=	+ 314_6CF23	Blatt	8
			Bearb.	Winkler								
			Gepr									
Anderung	Datum	Name	Urspr		Ersatz von						Blatt	387

VIPA\314-6CF23.EMA

A1

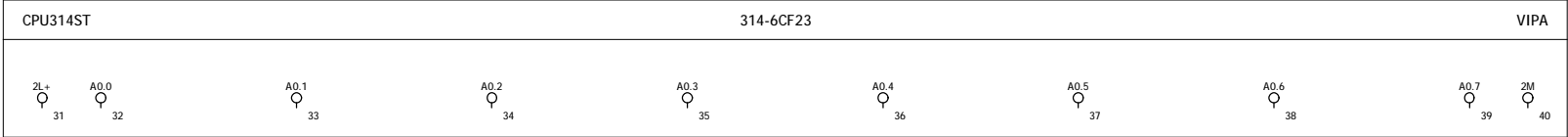

			Datum	19.12.2016	Produktmakros System 300S	YASKAWA	Ausgangsbyte 0 CPU 314ST, 314-6CF23	=	+ 314_6CF23	Blatt	9
			Bearb.	Winkler							
			Gepr								
Anderung	Datum	Name	Urspr		Ersatz von					Blatt	387

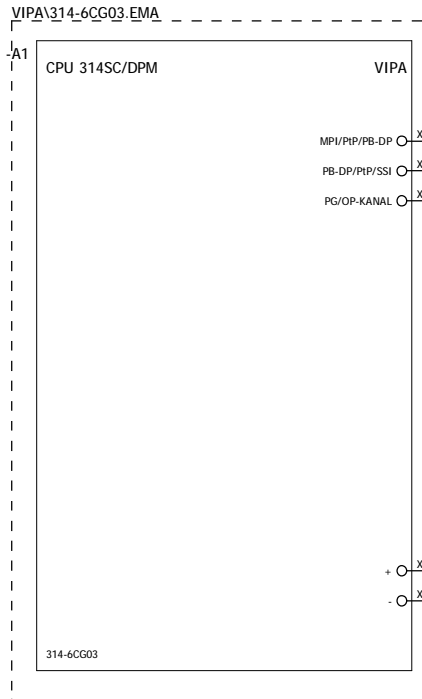

+314_6CF23/9

			Datum	08.05.2014	Produktmakros System 300S	YASKAWA	SPS-Übersicht CPU 314SC/DPM, 314-6CG03	=	+ 314_6CG03	Blatt	1
			Bearb.	Winkler						Blatt	387
			Gepr								
Anderung	Datum	Name	Urspr		Ersatz von						

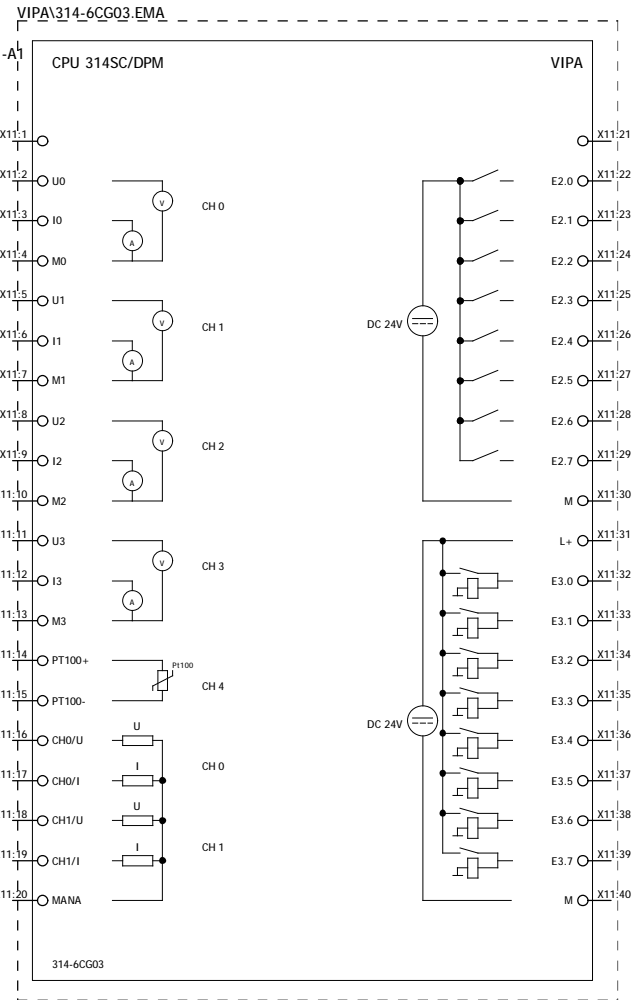

			Datum	08.05.2014	Produktmakros System 300S
			Bearb.	Winkler	
			Gepr.		
Anderung	Datum	Name	Urspr		Ersatz von



SPS-Übersicht
CPU 314SC/DPM,
314-6CG03

		=
		+ 314_6CG03
		Blatt 2
		Blatt 387

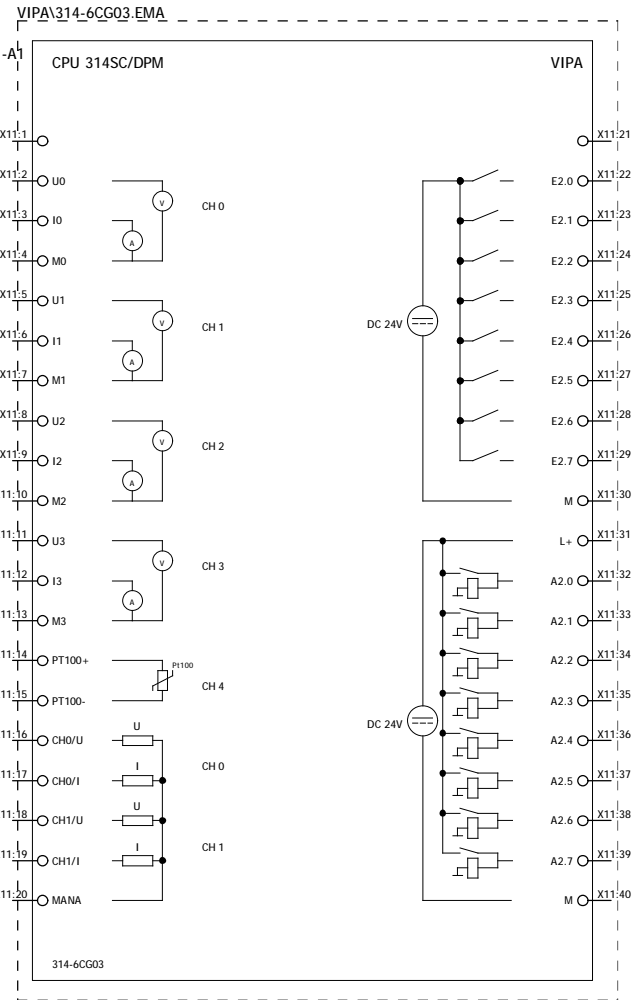

			Datum	08.05.2014	Produktmakros System 300S
			Bearb.	Winkler	
			Gepr.		
Anderung	Datum	Name	Urspr		Ersatz von



SPS-Übersicht
CPU 314SC/DPM,
314-6CG03

		=
		+ 314_6CG03
		Blatt 3
		Blatt 387

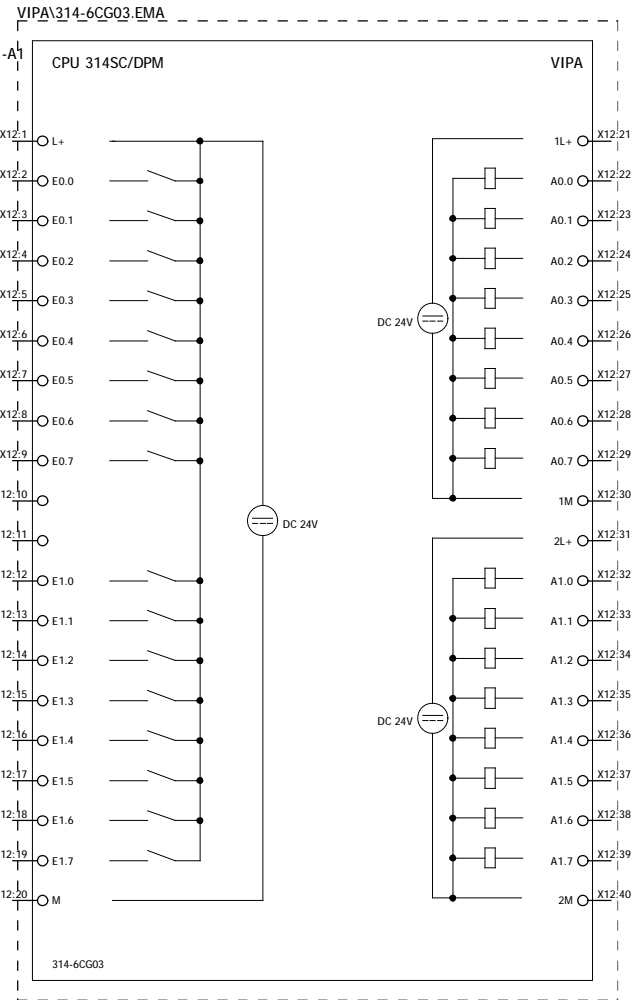

			Datum	08.05.2014	Produktmakros System 300S
			Bearb.	Winkler	
			Gepr.		
Anderung	Datum	Name	Urspr.		Ersatz von



SPS-Übersicht E/A-Bereich
CPU 314SC/DPM,
314-6CG03

		=
		+ 314_6CG03
		Blatt 4
		Blatt 387

VIPA314-6CG03.EMA

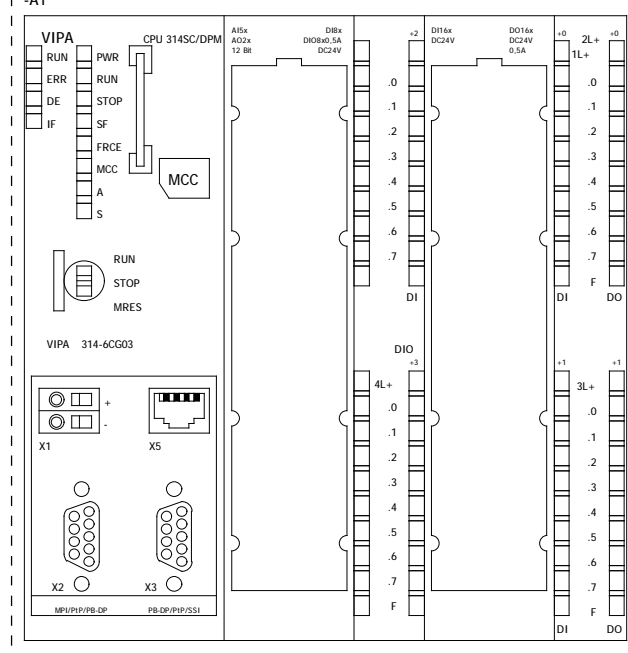

			Datum	29.11.2010	Produktmakros System 300S
			Bearb.	Winkler	
			Gepr.		
Anderung	Datum	Name	Urspr		Ersatz von



Frontansicht
CPU 314SC/DPM,
314-6CG03

		=
		+ 314_6CG03
	Blatt	5
	Blatt	387

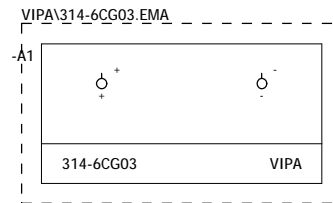
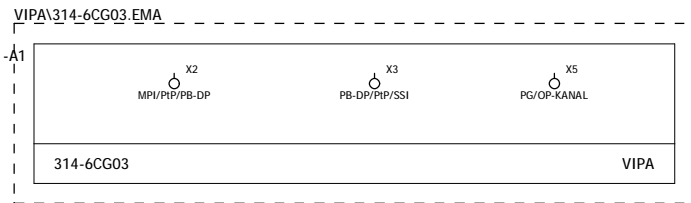

			Datum	08.05.2014	Produktmakros System 300S
			Bearb.	Winkler	
			Gepr.		
Anderung	Datum	Name	Urspr		Ersatz von



Anschlußbelegung
CPU 314SC/DPM,
314-6CG03

		=
		+ 314_6CG03
		Blatt 6
		Blatt 387

VIPA\314-6CG03.EMA

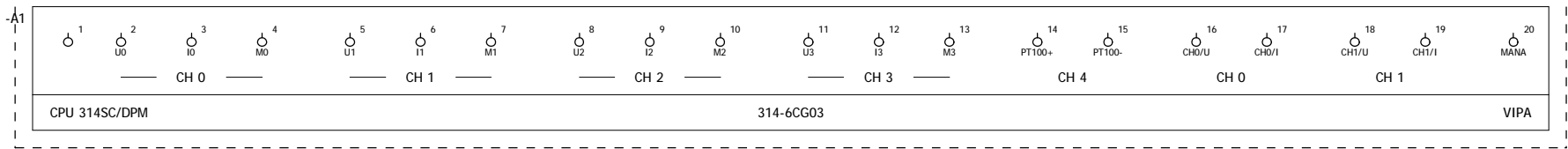

			Datum	08.05.2014	Produktmakros System 300S	YASKAWA	Analoge Ein-/Ausgänge CPU 314SC/DPM, 314-6CG03		=	+ 314_6CG03	Blatt 7
			Bearb.	Winkler							
			Gepr.								
Anderung	Datum	Name	Urspr		Ersatz von						Blatt 387

VIPA\314-6CG03.EMA

A1

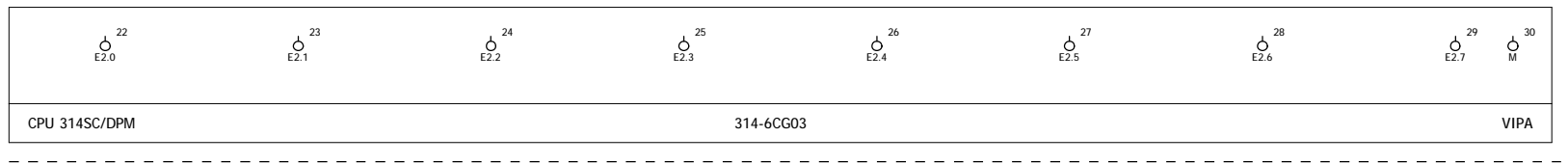

			Datum	08.05.2014	Produktmakros System 300S	YASKAWA	Eingangsbyte 2 CPU 314SC/DPM, 314-6CG03	=	+ 314_6CG03	Blatt	8
			Bearb.	Winkler							
			Gepr								
Anderung	Datum	Name	Urspr		Ersatz von					Blatt	387

VIPA\314-6CG03.EMA

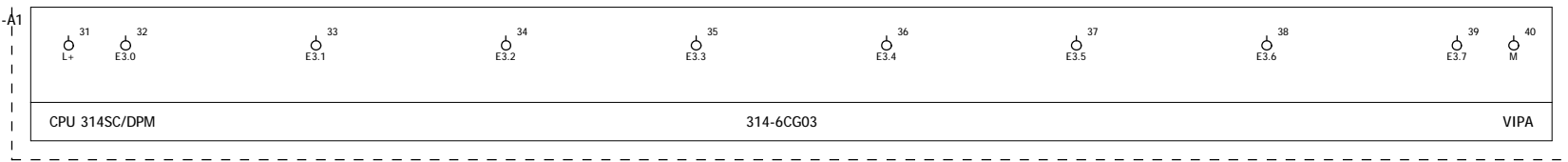

			Datum	08.05.2014	Produktmakros System 300S	YASKAWA	Eingangsbyte 3 CPU 314SC/DPM, 314-6CG03	=	+ 314_6CG03	Blatt	9
			Bearb.	Winkler							
			Gepr								
Anderung	Datum	Name	Urspr		Ersatz von					Blatt	387

VIPA\314-6CG03.EMA

A1

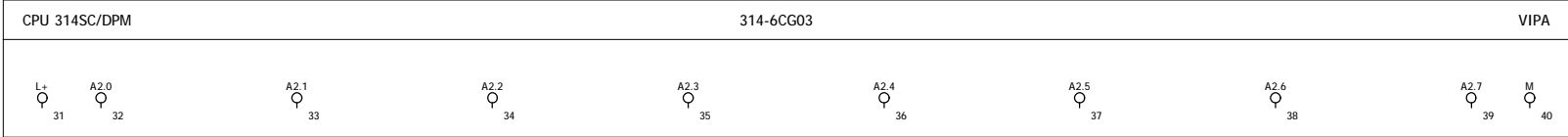

			Datum	08.05.2014	Produktmakros System 300S	YASKAWA	Ausgangsbyte 2 CPU 314SC/DPM, 314-6CG03	=	+ 314_6CG03	Blatt 10
			Bearb.	Winkler						
			Gepr							
Anderung	Datum	Name	Urspr		Ersatz von					Blatt 387

VIPA\314-6CG03.EMA

A1

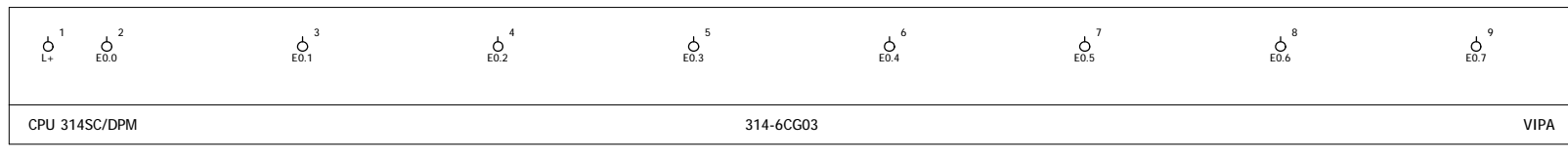

			Datum	08.05.2014	Produktmakros System 300S	YASKAWA	Eingangsbyte 0 CPU 314SC/DPM, 314-6CG03	=	+ 314_6CG03	Blatt 11
			Bearb.	Winkler						
			Gepr							
Anderung	Datum	Name	Urspr		Ersatz von					Blatt 387

VIPA\314-6CG03.EMA

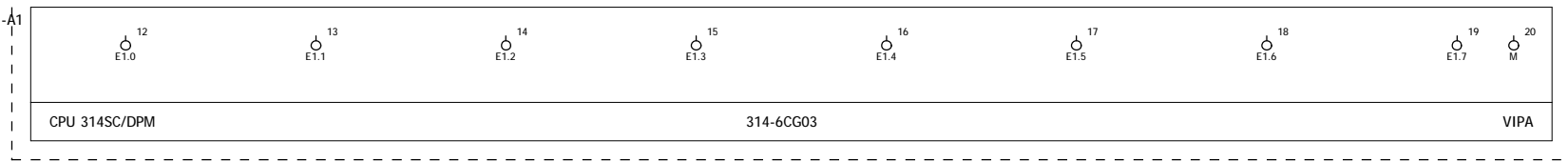

			Datum	08.05.2014	Produktmakros System 300S	YASKAWA	Eingangsbyte 1 CPU 314SC/DPM, 314-6CG03		=	+ 314_6CG03	Blatt 12
			Bearb.	Winkler							
			Gepr								
Anderung	Datum	Name	Urspr		Ersatz von						Blatt 387

VIPA\314-6CG03.EMA

A1

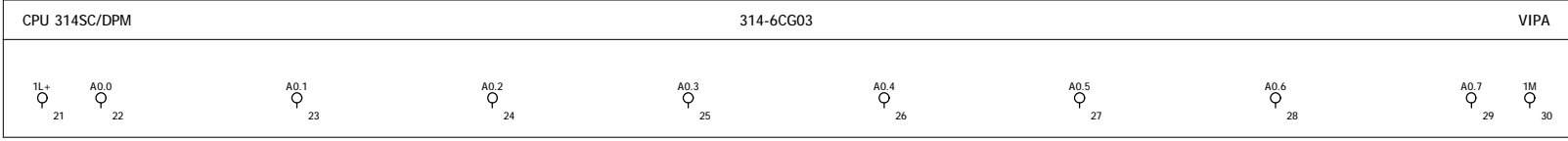

			Datum	08.05.2014	Produktmakros System 300S	YASKAWA	Ausgangsbyte 0 CPU 314SC/DPM, 314-6CG03	=	+ 314_6CG03	Blatt 13
			Bearb.	Winkler						
			Gepr							
Anderung	Datum	Name	Urspr		Ersatz von					Blatt 387

VIPA\314-6CG03.EMA

A1

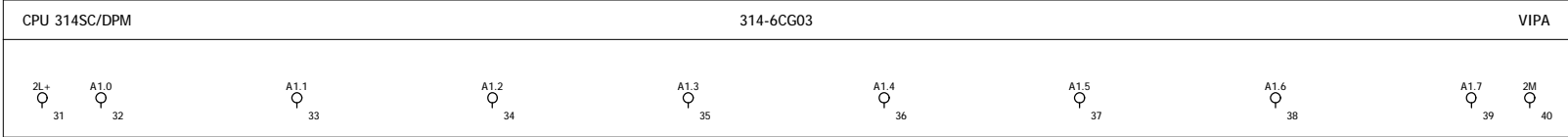

			Datum	08.05.2014	Produktmakros System 300S	YASKAWA	Ausgangsbyte 1 CPU 314SC/DPM, 314-6CG03		=	+ 314_6CG03	Blatt	14
			Bearb.	Winkler							Blatt	387
			Gepr									
Anderung	Datum	Name	Urspr		Ersatz von							

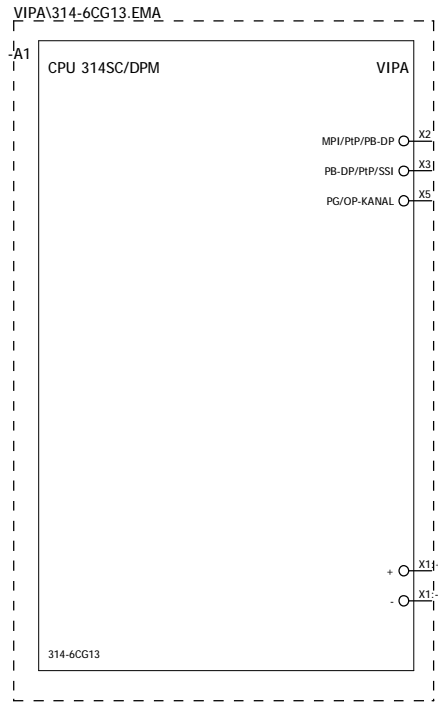

+314_6CG03/14

2

			Datum	08.05.2014	Produktmakros System 300S
			Bearb.	Winkler	
			Gepr		
Anderung	Datum	Name	Urspr		Ersatz von



SPS-Übersicht
CPU 314SC/DPM,
314-6CG13

		=
		+ 314_6CG13
		Blatt 1
		Blatt 387

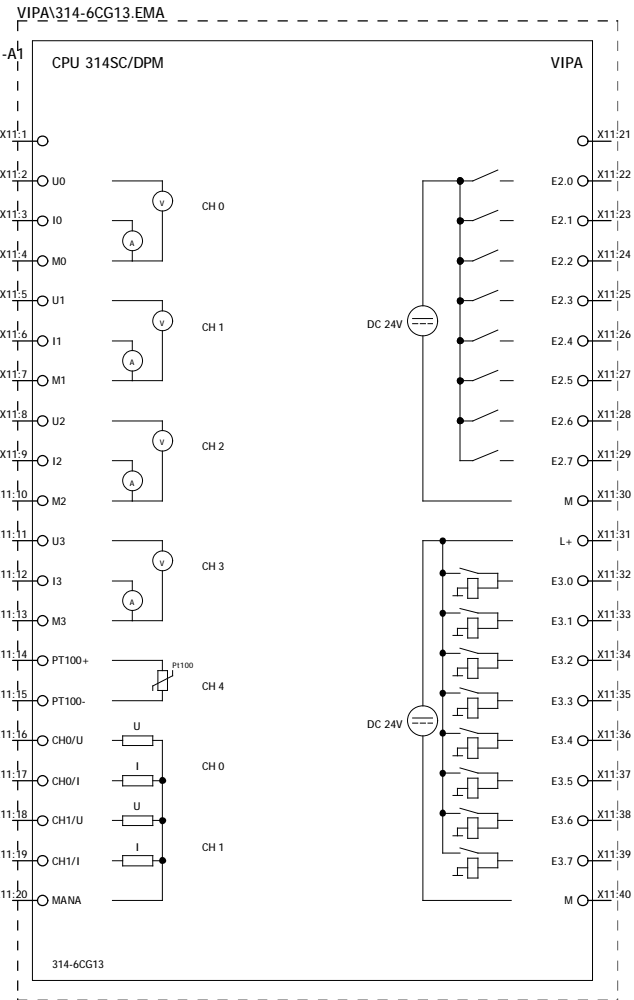

			Datum	08.05.2014	Produktmakros System 300S
			Bearb.	Winkler	
			Gepr.		
Anderung	Datum	Name	Urspr		Ersatz von



SPS-Übersicht
CPU 314SC/DPM,
314-6CG13

		=
		+ 314_6CG13
		Blatt 2
		Blatt 387

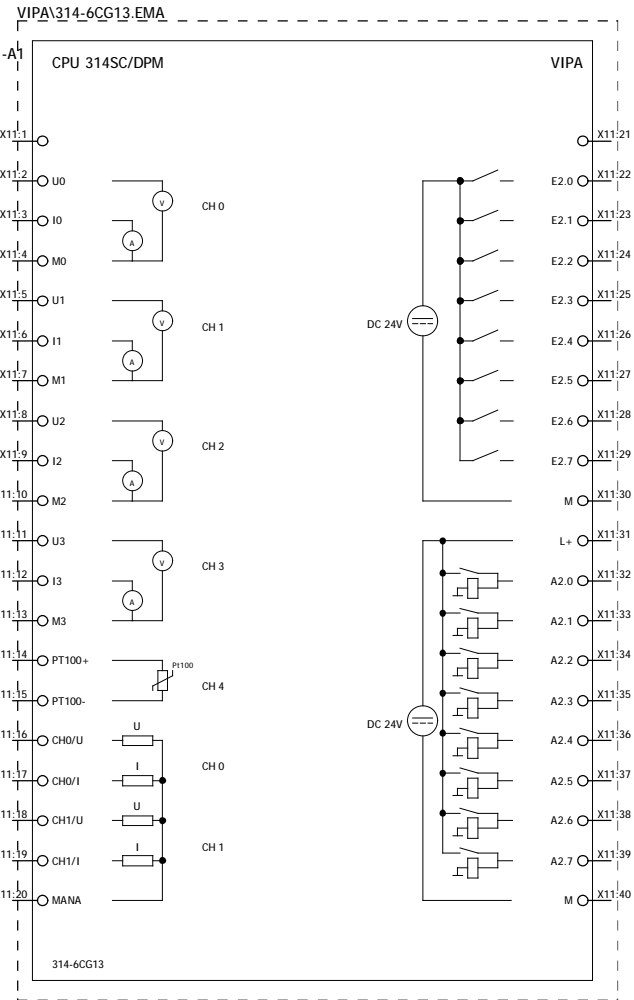

			Datum	08.05.2014	Produktmakros System 300S
			Bearb.	Winkler	
			Gepr		
Anderung	Datum	Name	Urspr		Ersatz von



SPS-Übersicht
CPU 314SC/DPM,
314-6CG13

		=
		+ 314_6CG13
		Blatt 3
		Blatt 387

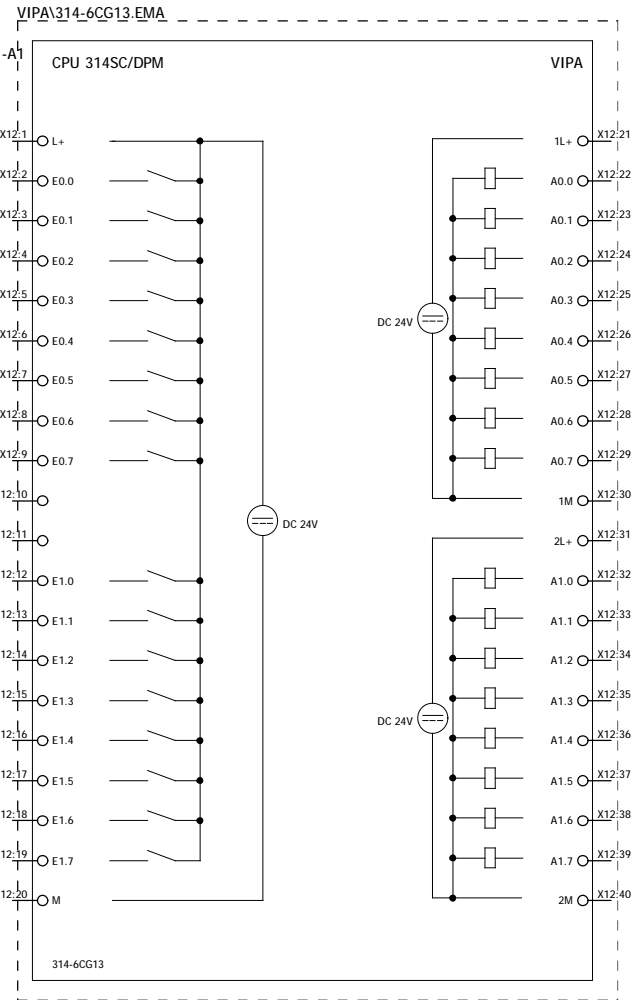

			Datum	08.05.2014	Produktmakros System 300S
			Bearb.	Winkler	
			Gepr.		
Anderung	Datum	Name	Urspr		Ersatz von



SPS-Übersicht E/A-Bereich
CPU 314SC/DPM,
314-6CG13

		=
		+ 314_6CG13
		Blatt 4
		Blatt 387

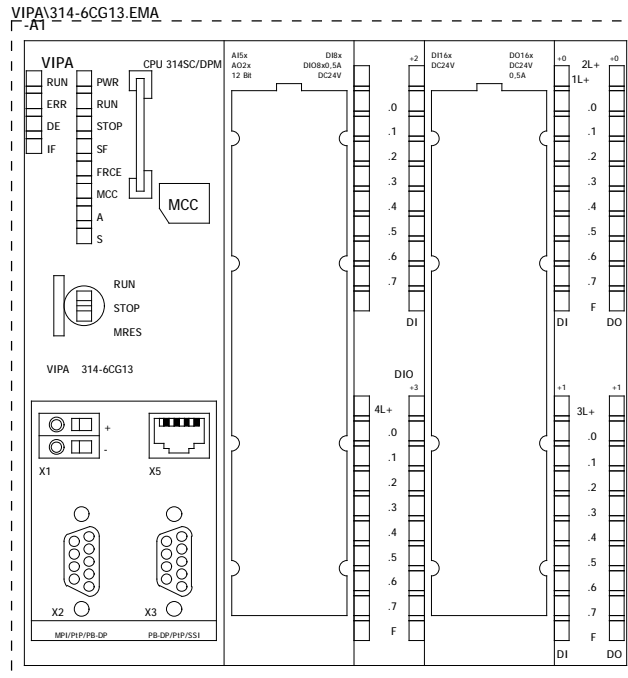

		Datum	29.10.2011	Produktmakros System 300S
		Bearb.	Winkler	
		Gepr		
Anderung	Datum	Name	Urspr	Ersatz von



Frontansicht
CPU 314SC/DPM,
314-6CG13

		=
		+ 314_6CG13
	Blatt	5
	Blatt	387

VIPA\314-6CG13.EMA



VIPA\314-6CG13.EMA

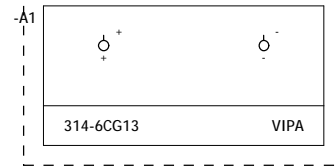

			Datum	08.05.2014	Produktmakros System 300S	YASKAWA	Anschlußbelegung CPU 314SC/DPM, 314-6CG13	=	+ 314_6CG13	Blatt	6
			Bearb.	Winkler							
			Gepr.								
Anderung	Datum	Name	Urspr		Ersatz von					Blatt	387

VIPA\314-6CG13.EMA

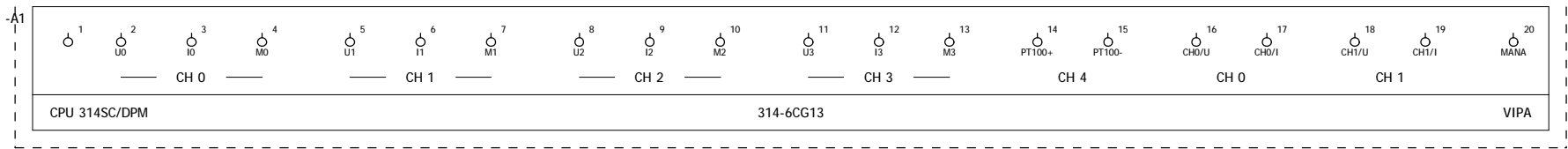

			Datum	08.05.2014	Produktmakros System 300S	YASKAWA	Analoge Ein-/Ausgänge CPU 314SC/DPM, 314-6CG13		=	+ 314_6CG13	Blatt 7
			Bearb.	Winkler							
			Gepr								
Anderung	Datum	Name	Urspr		Ersatz von						Blatt 387

VIPA\314-6CG13.EMA

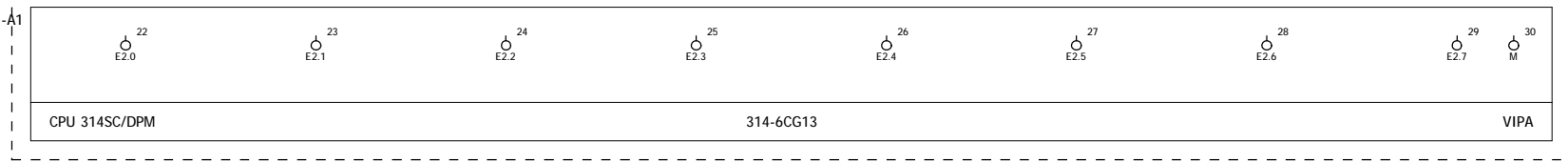

			Datum	08.05.2014	Produktmakros System 300S	YASKAWA	Eingangsbyte 2 CPU 314SC/DPM, 314-6CG13	=	+ 314_6CG13	Blatt 8	Blatt 387
			Bearb.	Winkler							
			Gepr								
Anderung	Datum	Name	Urspr		Ersatz von						

VIPA\314-6CG13.EMA

A1

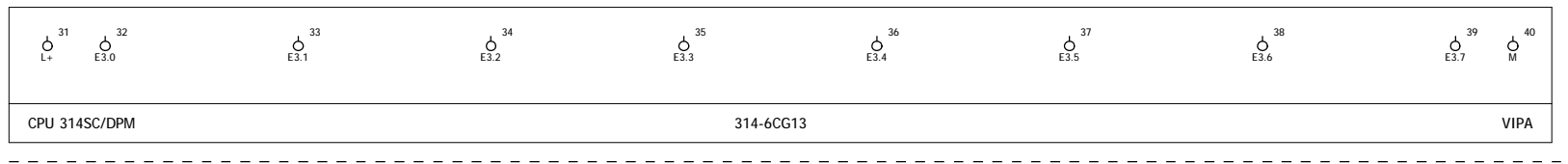

			Datum	08.05.2014	Produktmakros System 300S	YASKAWA	Eingangsbyte 3 CPU 314SC/DPM, 314-6CG13	=	+ 314_6CG13	Blatt	9
			Bearb.	Winkler							
			Gepr								
Anderung	Datum	Name	Urspr		Ersatz von					Blatt	387

VIPA\314-6CG13.EMA

A1

CPU 314SC/DPM

314-6CG13

VIPA



			Datum	08.05.2014	Produktmakros System 300S	YASKAWA	Ausgangsbyte 2 CPU 314SC/DPM, 314-6CG13	=	+ 314_6CG13	Blatt 10
			Bearb.	Winkler						
			Gepr							
Anderung	Datum	Name	Urspr		Ersatz von					Blatt 387

VIPA\314-6CG13.EMA

A1

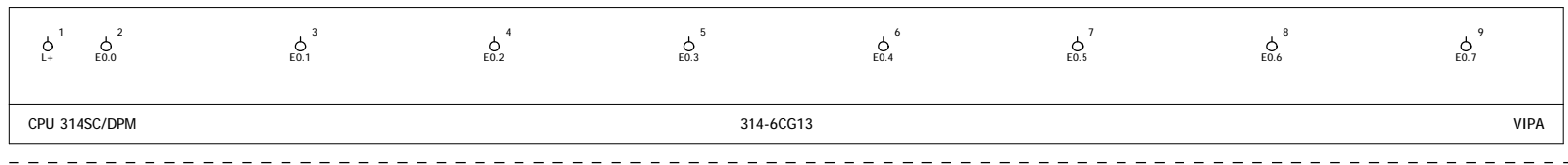

			Datum	08.05.2014	Produktmakros System 300S	YASKAWA	Eingangsbyte 0 CPU 314SC/DPM, 314-6CG13		=	+ 314_6CG13	Blatt 11
			Bearb.	Winkler							
			Gepr								
Anderung	Datum	Name	Urspr		Ersatz von						Blatt 387

VIPA\314-6CG13.EMA

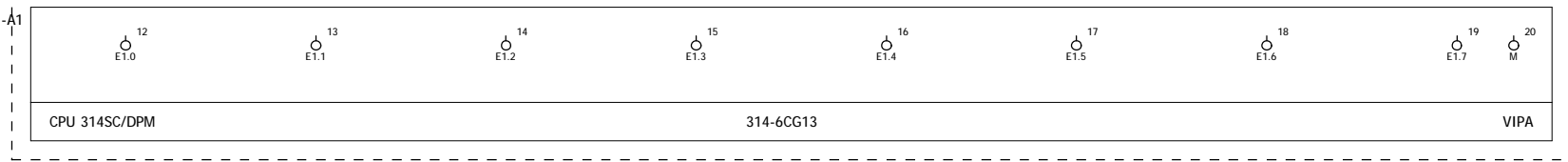

			Datum	08.05.2014	Produktmakros System 300S	YASKAWA	Eingangsbyte 1 CPU 314SC/DPM, 314-6CG13		=	+ 314_6CG13	Blatt 12
			Bearb.	Winkler							
			Gepr								
Anderung	Datum	Name	Urspr		Ersatz von						Blatt 387

VIPA\314-6CG13.EMA

A1

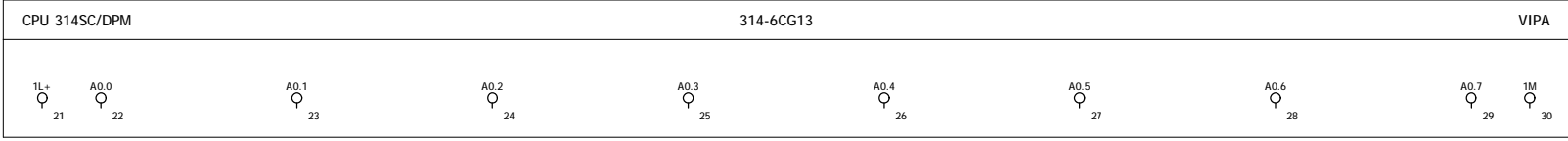

			Datum	08.05.2014	Produktmakros System 300S	YASKAWA	Ausgangsbyte 0 CPU 314SC/DPM, 314-6CG13	=	+ 314_6CG13	Blatt 13
			Bearb.	Winkler						
			Gepr							
Anderung	Datum	Name	Urspr		Ersatz von					Blatt 387

VIPA\314-6CG13.EMA

A1

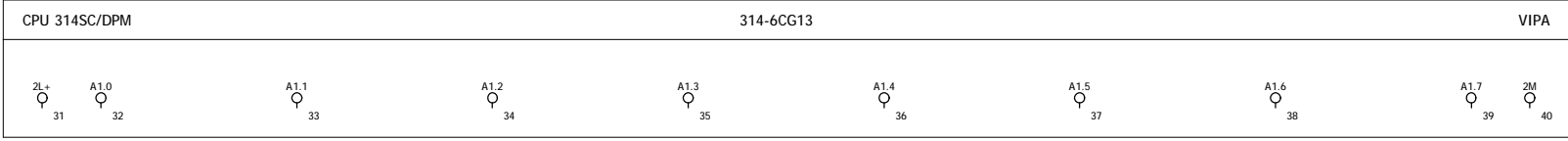

			Datum	08.05.2014	Produktmakros System 300S	YASKAWA	Ausgangsbyte 1 CPU 314SC/DPM, 314-6CG13		=	+ 314_6CG13	Blatt	14
			Bearb.	Winkler							Blatt	387
			Gepr									
Anderung	Datum	Name	Urspr		Ersatz von							

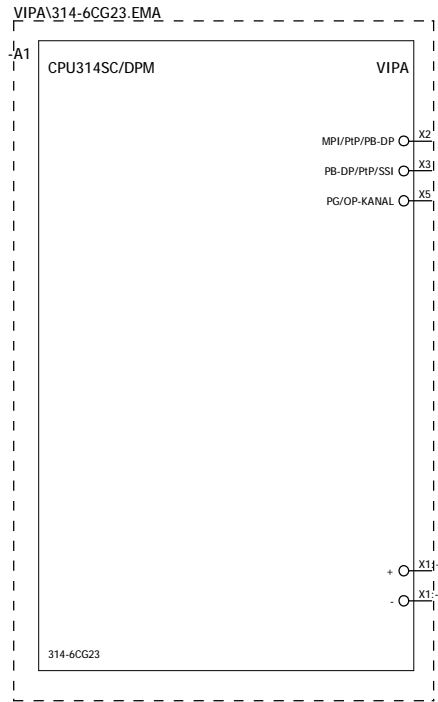

+314_6CG13/14

2

			Datum	19.12.2016	Produktmakros System 300S
			Bearb.	Winkler	
			Gepr		
Anderung	Datum	Name	Urspr		Ersatz von



SPS-Übersicht
CPU 314SC/DPM,
314-6CG23

		=
		+ 314_6CG23
		Blatt 1
		Blatt 387

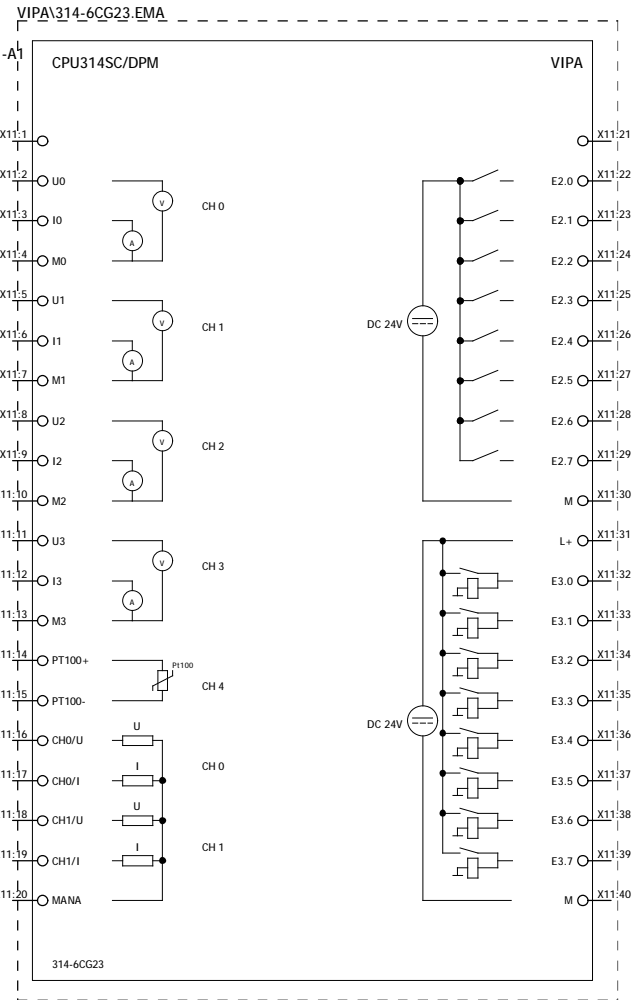

			Datum	19.12.2016	Produktmakros System 300S
			Bearb.	Winkler	
			Gepr.		
Anderung	Datum	Name	Urspr		Ersatz von



SPS-Übersicht
CPU 314SC/DPM,
314-6CG23

		=
		+ 314_6CG23
	Blatt	2
	Blatt	387

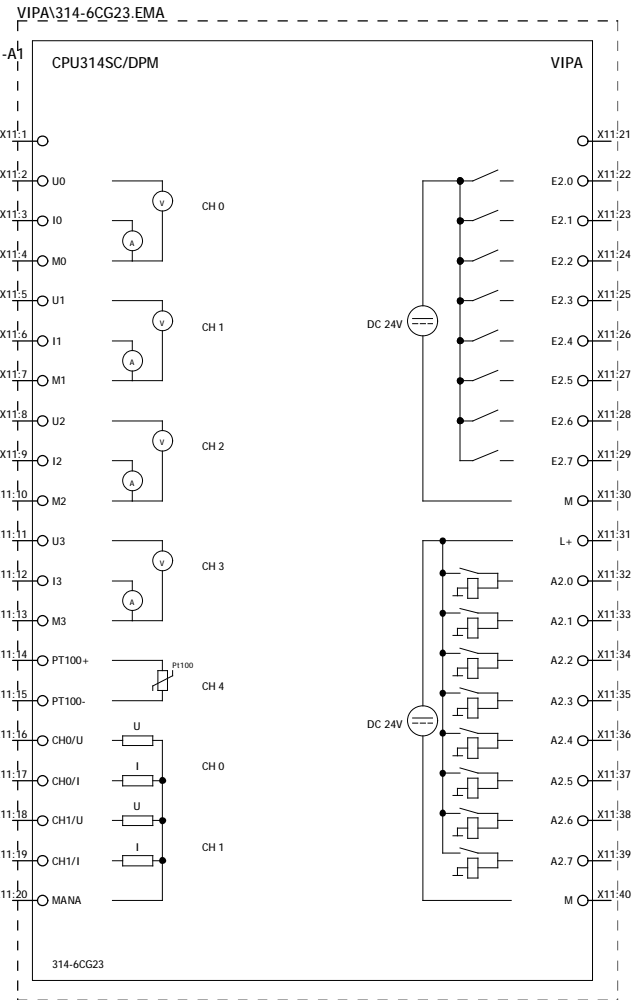

			Datum	19.12.2016	Produktmakros System 300S
			Bearb.	Winkler	
			Gepr.		
Anderung	Datum	Name	Urspr		Ersatz von



SPS-Übersicht
CPU 314SC/DPM,
314-6CG23

		=
		+ 314_6CG23
		Blatt 3
		Blatt 387

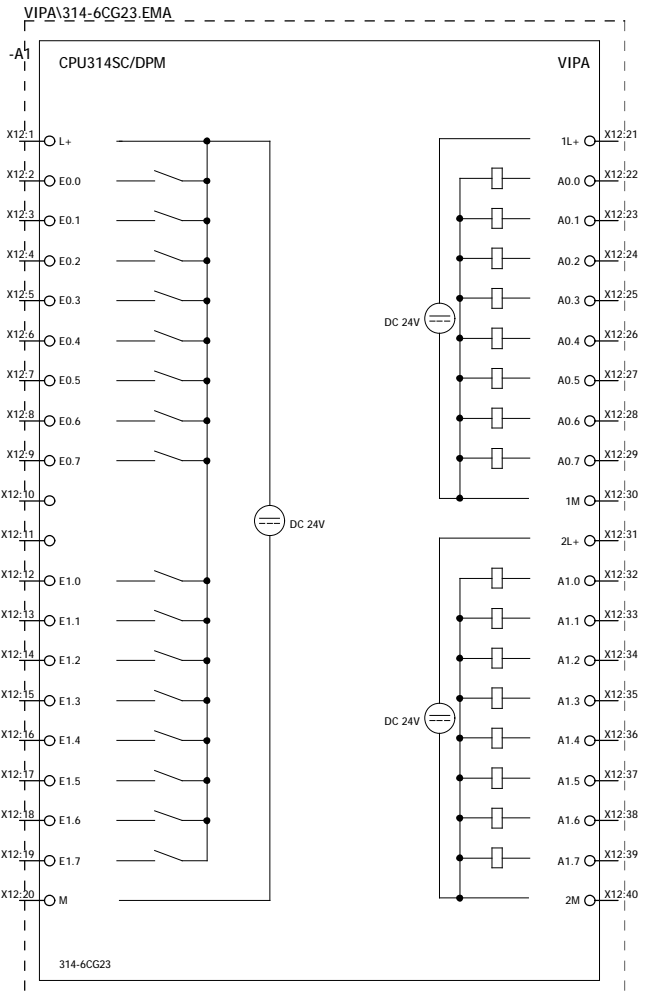

			Datum	19.12.2016	Produktmakros System 300S
			Bearb.	Winkler	
			Gepr.		
Anderung	Datum	Name	Urspr		Ersatz von



SPS-Übersicht E/A-Bereich
CPU 314SC/DPM,
314-6CG23

		=
		+ 314_6CG23
		Blatt 4
		Blatt 387

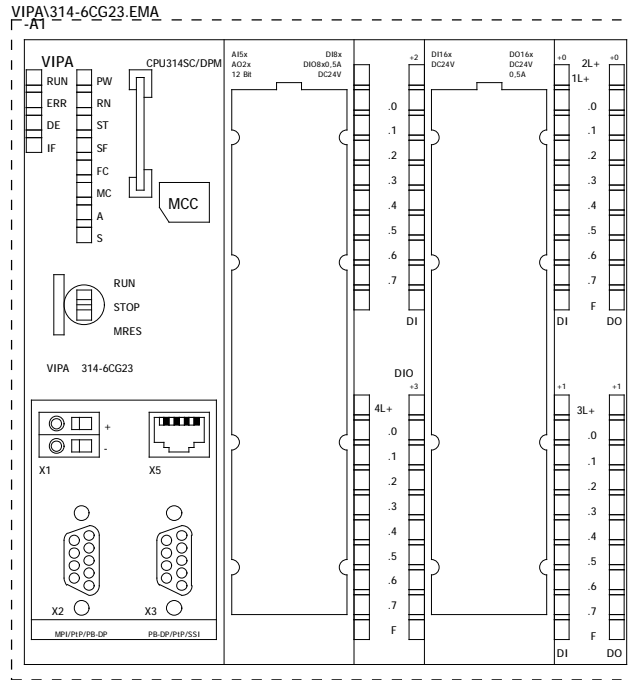

			Datum	20.12.2016	Produktmakros System 300S
			Bearb.	Winkler	
			Gepr.		
Anderung	Datum	Name	Urspr		Ersatz von



Frontansicht
CPU 314SC/DPM,
314-6CG23

		=
		+ 314_6CG23
		Blatt 5
		Blatt 387

VIPA\314-6CG23.EMA

-A1

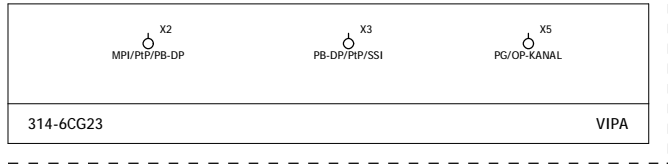

VIPA\314-6CG23.EMA

-A1

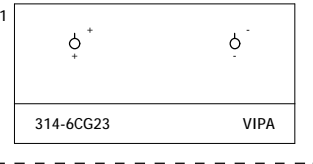

		Datum	19.12.2016	Produktmakros System 300S
		Bearb.	Winkler	
		Gepr.		
Anderung	Datum	Name	Urspr	Ersatz von



Anschlußbelegung
CPU 314SC/DPM,
314-6CG23

	=	
	+ 314_6CG23	
		Blatt 6
		Blatt 387

VIPA\314-6CG23.EMA

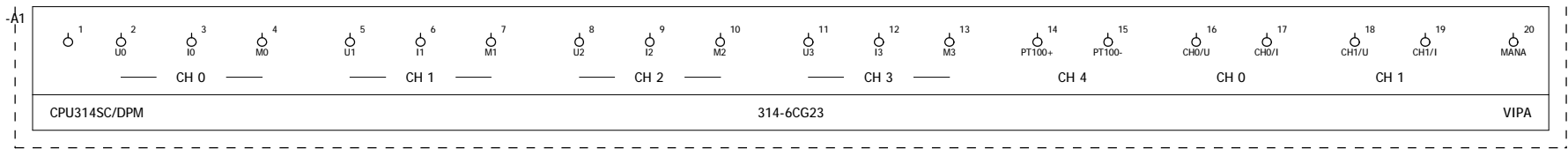

			Datum	19.12.2016	Produktmakros System 300S	YASKAWA	Analoge Ein-/Ausgänge CPU 314SC/DPM, 314-6CG23		=	+ 314_6CG23	Blatt	7
			Bearb.	Winkler								
			Gepr									
Anderung	Datum	Name	Urspr		Ersatz von						Blatt	387

VIPA\314-6CG23.EMA

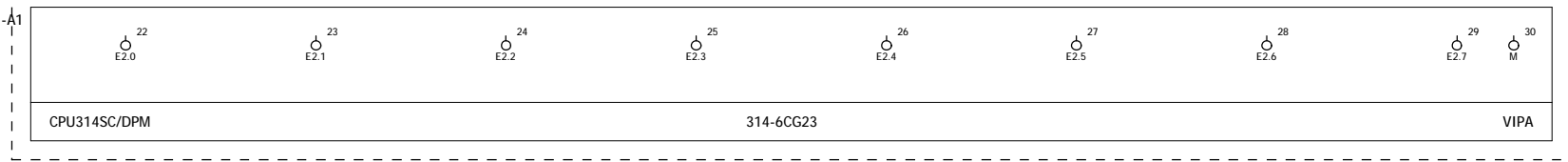

			Datum	19.12.2016	Produktmakros System 300S	YASKAWA	Eingangsbyte 2 CPU 314SC/DPM, 314-6CG23		=	+ 314_6CG23	Blatt 8
			Bearb.	Winkler							
			Gepr								
Anderung	Datum	Name	Urspr		Ersatz von						Blatt 387

VIPA\314-6CG23.EMA

A1

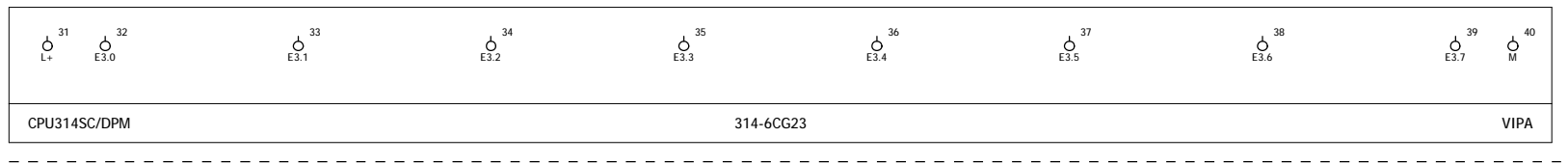

			Datum	19.12.2016	Produktmakros System 300S	YASKAWA	Eingangsbyte 3 CPU 314SC/DPM, 314-6CG23	=	+ 314_6CG23	Blatt	9
			Bearb.	Winkler							
			Gepr								
Anderung	Datum	Name	Urspr		Ersatz von					Blatt	387

VIPA\314-6CG23.EMA

A1

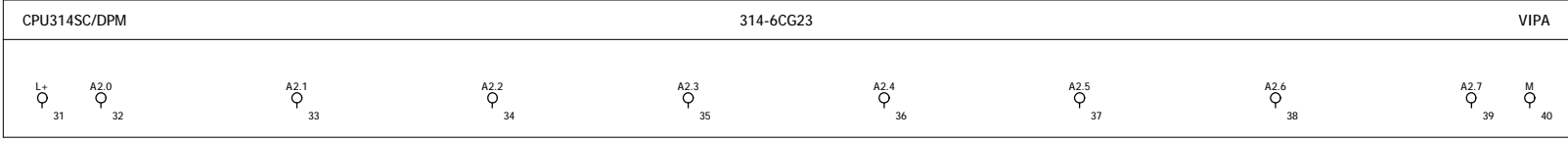

			Datum	19.12.2016	Produktmakros System 300S	YASKAWA	Ausgangsbyte 2 CPU 314SC/DPM, 314-6CG23	=	+ 314_6CG23	Blatt 10
			Bearb.	Winkler						
			Gepr							
Anderung	Datum	Name	Urspr		Ersatz von					Blatt 387

VIPA\314-6CG23.EMA

A1

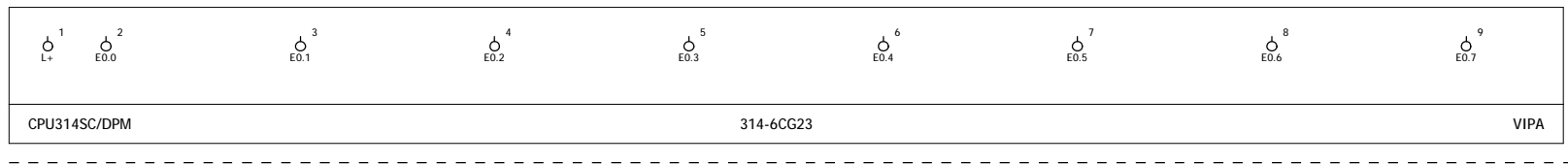

			Datum	19.12.2016	Produktmakros System 300S	YASKAWA	Eingangsbyte 0 CPU 314SC/DPM, 314-6CG23	=	+ 314_6CG23	Blatt 11
			Bearb.	Winkler						
			Gepr							
Anderung	Datum	Name	Urspr		Ersatz von					Blatt 387

VIPA\314-6CG23.EMA

A1

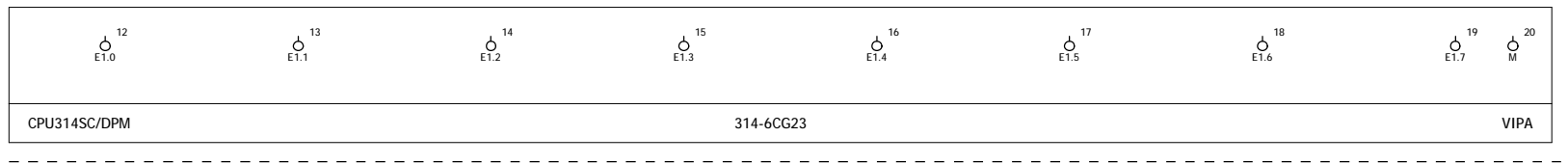

			Datum	19.12.2016	Produktmakros System 300S	YASKAWA	Eingangsbyte 1 CPU 314SC/DPM, 314-6CG23		=	+ 314_6CG23	Blatt 12
			Bearb.	Winkler							
			Gepr								
Anderung	Datum	Name	Urspr		Ersatz von						Blatt 387

VIPA\314-6CG23.EMA

A1

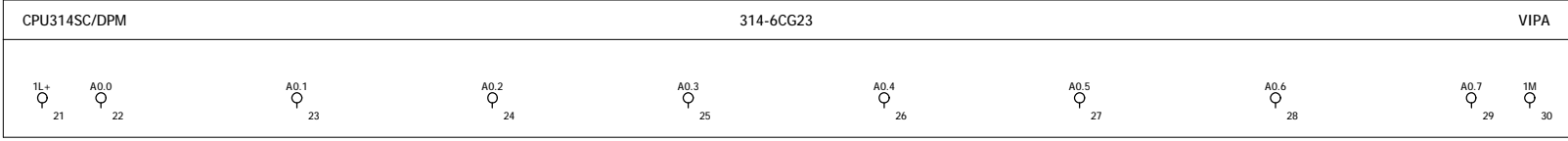

			Datum	19.12.2016	Produktmakros System 300S	YASKAWA	Ausgangsbyte 0 CPU 314SC/DPM, 314-6CG23	=	+ 314_6CG23	Blatt 13
			Bearb.	Winkler						
			Gepr							
Anderung	Datum	Name	Urspr		Ersatz von					Blatt 387

VIPA\314-6CG23.EMA

A1

CPU314SC/DPM

314-6CG23

VIPA



			Datum	19.12.2016	Produktmakros System 300S	YASKAWA	Ausgangsbyte 1 CPU 314SC/DPM, 314-6CG23		=	+ 314_6CG23	Blatt	14
			Bearb.	Winkler							Blatt	387
			Gepr									
Anderung	Datum	Name	Urspr		Ersatz von							

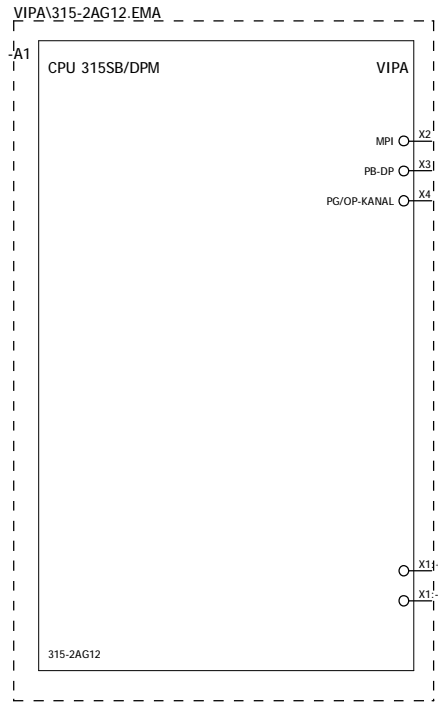

+314_6CG23/14

			Datum	08.05.2014	Produktmakros System 300S
			Bearb.	Winkler	
			Gepr		
Anderung	Datum	Name	Urspr		Ersatz von



SPS-Übersicht
CPU 315SB/DPM,
315-2AG12

		=
		+ 315_2AG12
		Blatt 1
		Blatt 387

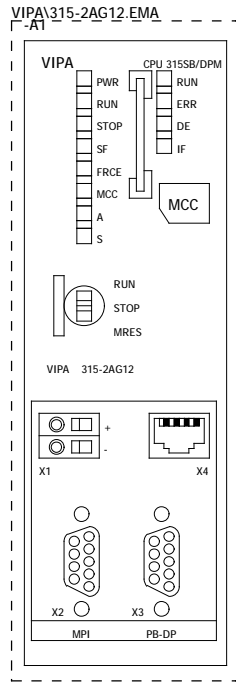

			Datum	29.11.2010	Produktmakros System 300S
			Bearb.	Winkler	
			Gepr		
Anderung	Datum	Name	Urspr		Ersatz von



Frontansicht
CPU 315SB/DPM,
315-2AG12

		=
		+ 315_2AG12
		Blatt 2
		Blatt 387

VIPA\315-2AG12.EMA

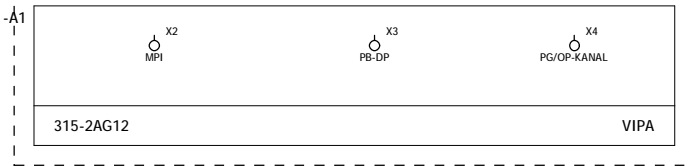

VIPA\315-2AG12.EMA

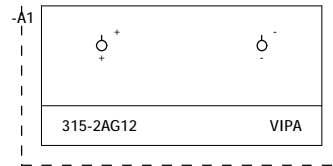

			Datum	08.05.2014	Produktmakros System 300S
			Bearb.	Winkler	
			Gepr.		
Anderung	Datum	Name	Urspr.		Ersatz von



Anschlußbelegung
CPU 315SB/DPM,
315-2AG12

		=
		+ 315_2AG12
		Blatt 3
		Blatt 387

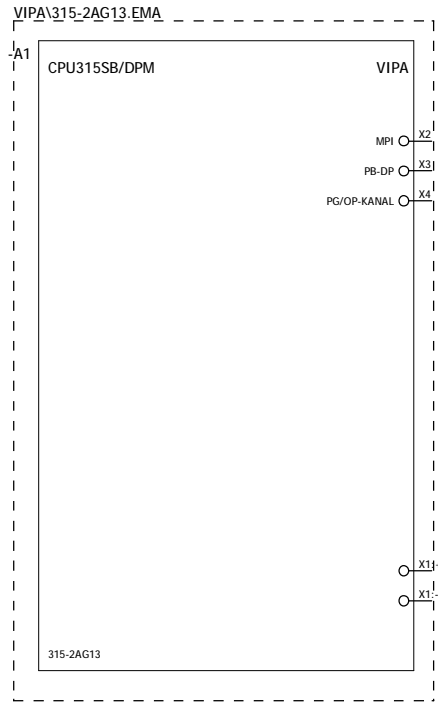

+315_2AG12/3

2

			Datum	08.05.2014	Produktmakros System 300S
			Bearb.	Winkler	
			Gepr		
Anderung	Datum	Name	Urspr		Ersatz von



SPS-Übersicht
CPU 315SB/DPM,
315-2AG13

=
+ 315_2AG13

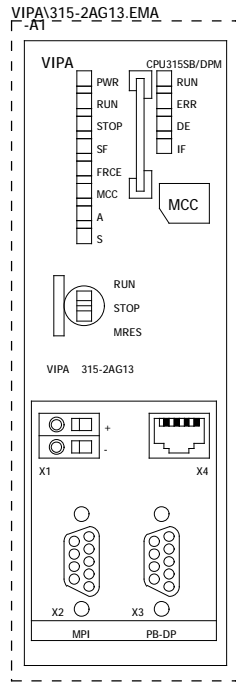

			Datum	08.05.2014	Produktmakros System 300S
			Bearb.	Winkler	
			Gepr.		
Anderung	Datum	Name	Urspr		Ersatz von



Frontansicht
CPU 315SB/DPM,
315-2AG13

		=
		+ 315_2AG13
		Blatt 2
		Blatt 387

VIPA\315-2AG13.EMA

-A1

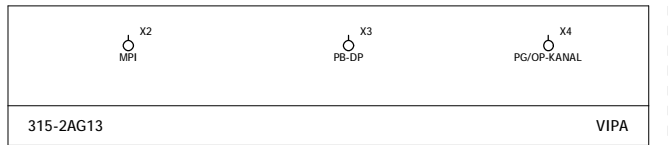

VIPA\315-2AG13.EMA

-A1

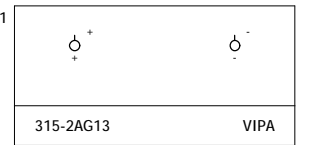

			Datum	08.05.2014	Produktmakros System 300S
			Bearb.	Winkler	
			Gepr.		
Anderung	Datum	Name	Urspr.		Ersatz von



Anschlußbelegung
CPU 315SB/DPM,
315-2AG13

		=
		+ 315_2AG13
		Blatt 3
		Blatt 387

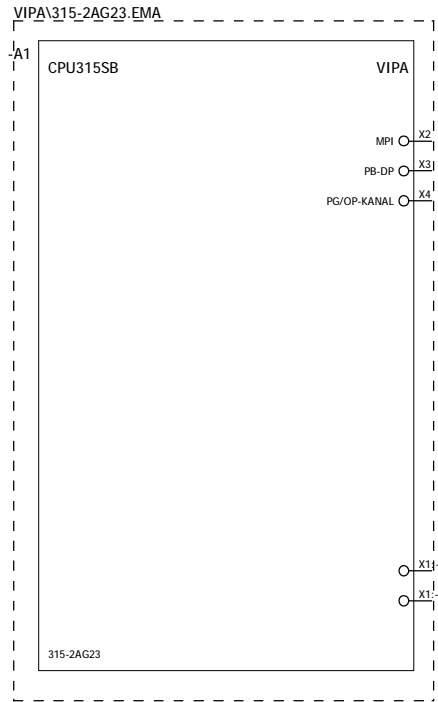

+315_2AG13/3

			Datum	19.12.2016	Produktmakros System 300S
			Bearb.	Winkler	
			Gepr		
Anderung	Datum	Name	Urspr		Ersatz von



SPS-Übersicht
CPU 315SB,
315-2AG23

		=
		+ 315_2AG23
		Blatt 1
		Blatt 387

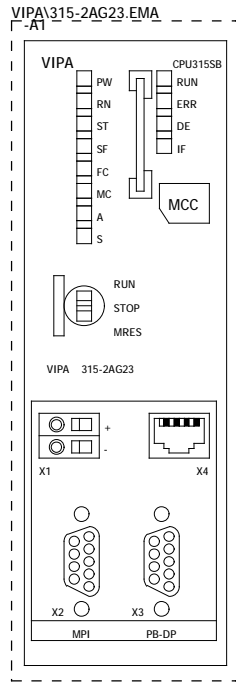

			Datum	20.12.2016	Produktmakros System 300S
			Bearb.	Winkler	
			Gepr		
Anderung	Datum	Name	Urspr		Ersatz von



Frontansicht
CPU 315SB,
315-2AG23

		=
		+ 315_2AG23
		Blatt 2
		Blatt 387

VIPA\315-2AG23.EMA

-A1

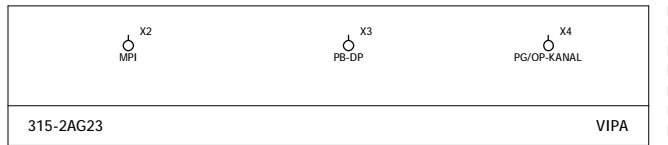

VIPA\315-2AG23.EMA

-A1

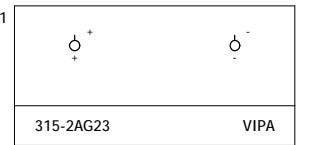

			Datum	19.12.2016	Produktmakros System 300S
			Bearb.	Winkler	
			Gepr.		
Anderung	Datum	Name	Urspr.		Ersatz von



Anschlußbelegung
CPU 315SB,
315-2AG23

		=	
		+ 315_2AG23	
			Blatt 3
			Blatt 387

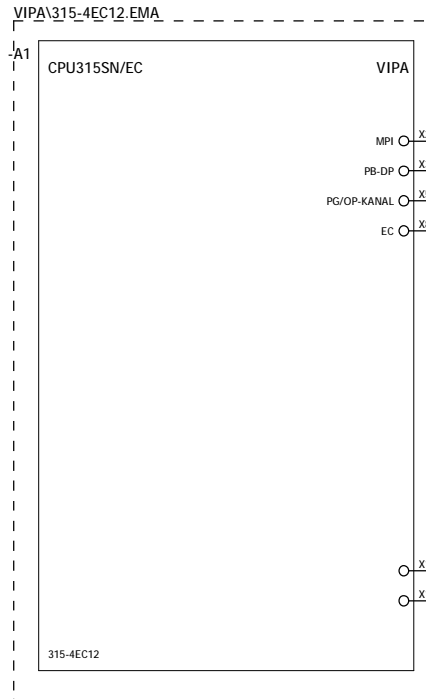

+315_2AG23/3

2

			Datum	08.05.2014	Produktmakros System 300S
			Bearb.	Winkler	
			Gepr		
Anderung	Datum	Name	Urspr		Ersatz von



SPS-Übersicht
CPU 315SN/EC,
315-4EC12

=
+ 315_4EC12

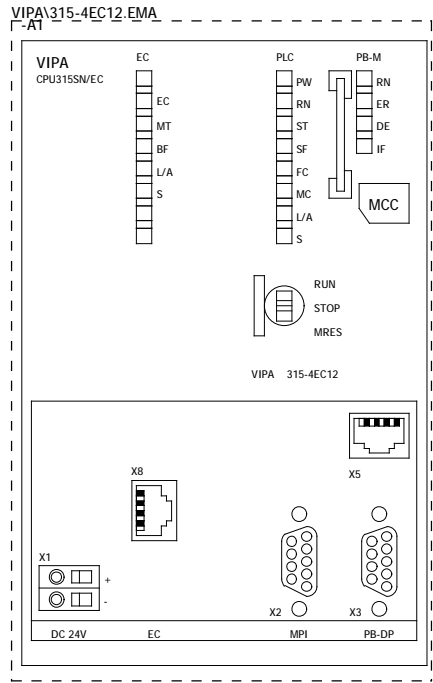

			Datum	08.05.2014	Produktmakros System 300S
			Bearb.	Winkler	
			Gepr.		
Anderung	Datum	Name	Urspr		Ersatz von



Frontansicht
CPU 315SN/EC,
315-4EC12

		=
		+ 315_4EC12
		Blatt 2
		Blatt 387

VIPA\315-4EC12.EMA

-A1

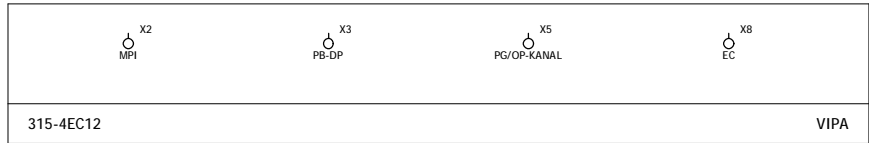

VIPA\315-4EC12.EMA

-A1



			Datum	08.05.2014	Produktmakros System 300S
			Bearb.	Winkler	
			Gepr.		
Anderung	Datum	Name	Urspr		Ersatz von



Anschlußbelegung
CPU 315SN/EC,
315-4EC12

		=
		+ 315_4EC12
		Blatt 3
		Blatt 387

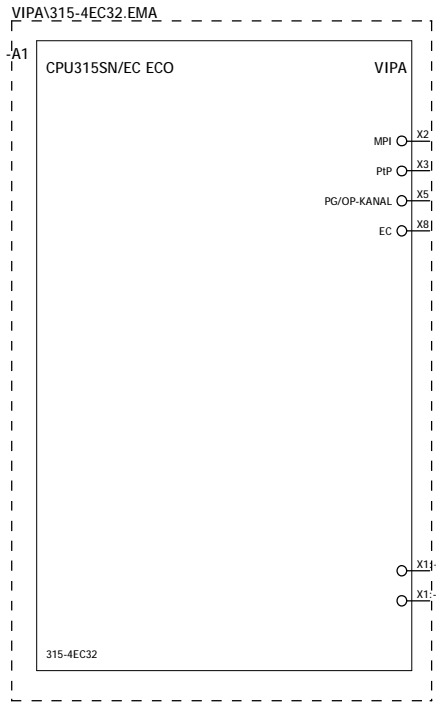

+315_4EC12/3

2

			Datum	12.05.2014	Produktmakros System 300S
			Bearb.	Winkler	
			Gepr		
Anderung	Datum	Name	Urspr		Ersatz von



SPS-Übersicht
CPU 315SN/EC,
315-4EC32

=
+ 315_4EC32

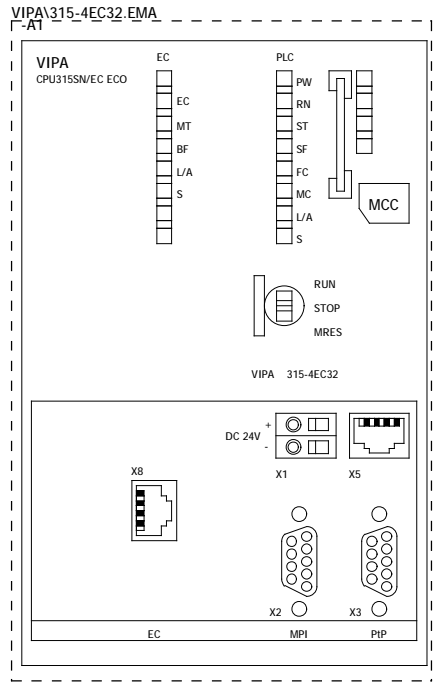

			Datum	08.05.2014	Produktmakros System 300S
			Bearb.	Winkler	
			Gepr		
Anderung	Datum	Name	Urspr		Ersatz von



Frontansicht
CPU 315SN/EC,
315-4EC32

		=
		+ 315_4EC32
		Blatt 2
		Blatt 387

VIPA\315-4EC32.EMA

-A1

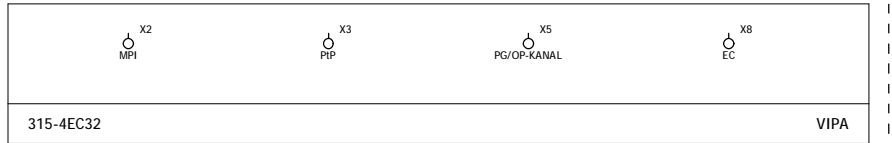

VIPA\315-4EC32.EMA

-A1

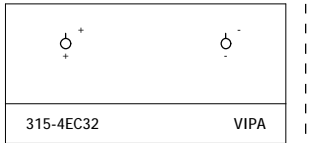

			Datum	12.05.2014	Produktmakros System 300S
			Bearb.	Winkler	
			Gepr		
Anderung	Datum	Name	Urspr		Ersatz von



Anschlußbelegung
CPU 315SN/EC,
315-4EC32

		=	
		+ 315_4EC32	
			Blatt 3
			Blatt 387

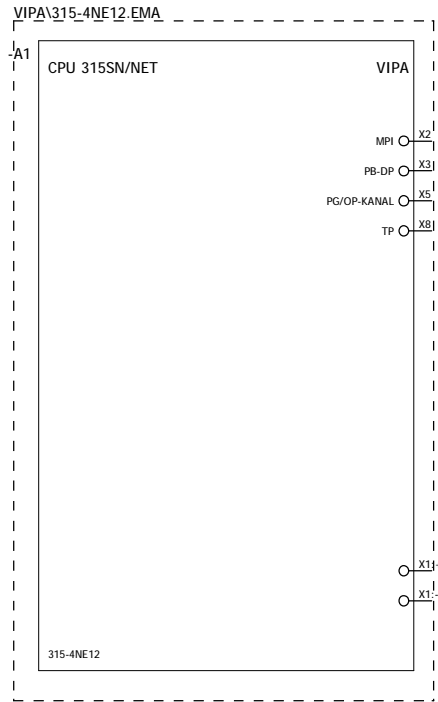

+315_4EC32/3

2

			Datum	08.05.2014	Produktmakros System 300S
			Bearb.	Winkler	
			Gepr		
Anderung	Datum	Name	Urspr		Ersatz von



SPS-Übersicht
CPU 315SN/NET,
315-4NE12

		=
		+ 315_4NE12
	Blatt	1
	Blatt	387

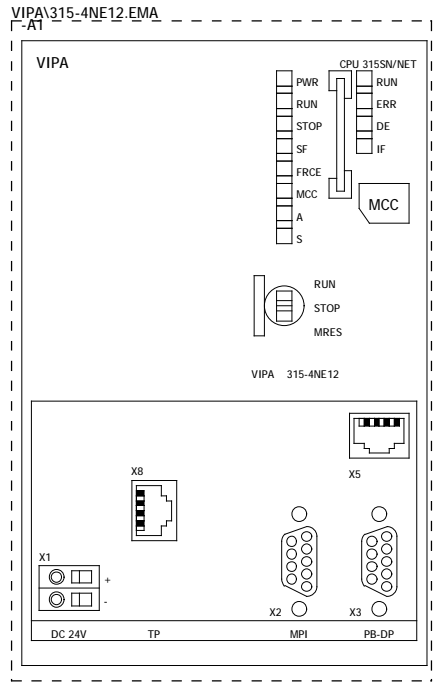

			Datum	29.11.2010	Produktmakros System 300S
			Bearb.	Winkler	
			Gepr		
Anderung	Datum	Name	Urspr		Ersatz von



Frontansicht
CPU 315SN/NET,
315-4NE12

		=
		+ 315_4NE12
		Blatt 2
		Blatt 387

VIPA\315-4NE12.EMA

-A1

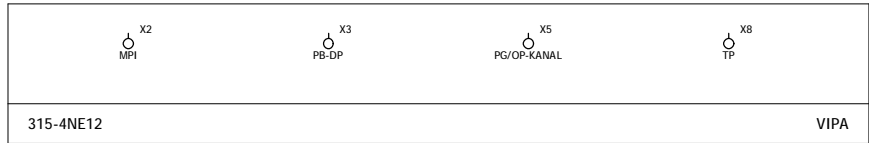

VIPA\315-4NE12.EMA

-A1

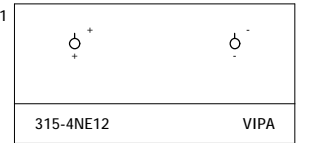

			Datum	08.05.2014	Produktmakros System 300S
			Bearb.	Winkler	
			Gepr.		
Anderung	Datum	Name	Urspr.		Ersatz von



Anschlußbelegung
CPU 315SN/NET,
315-4NE12

		=	
		+ 315_4NE12	
			Blatt 3
			Blatt 387

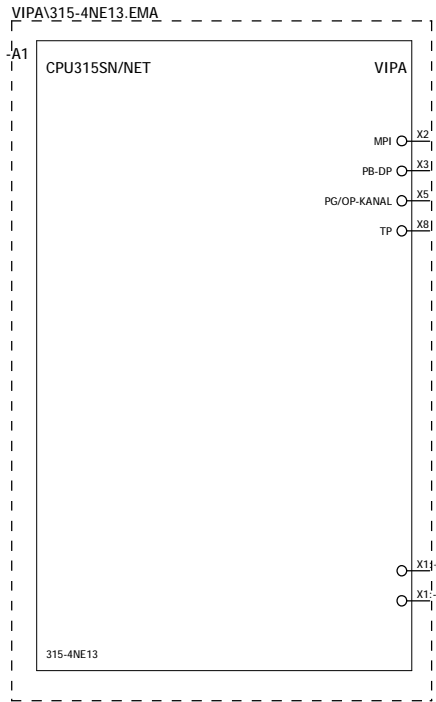

+315_4NE12/3

2

			Datum	08.05.2014	Produktmakros System 300S
			Bearb.	Winkler	
			Gepr		
Anderung	Datum	Name	Urspr		Ersatz von



SPS-Übersicht
CPU 315SN/NET,
315-4NE13

		=
		+ 315_4NE13
	Blatt	1
	Blatt	387

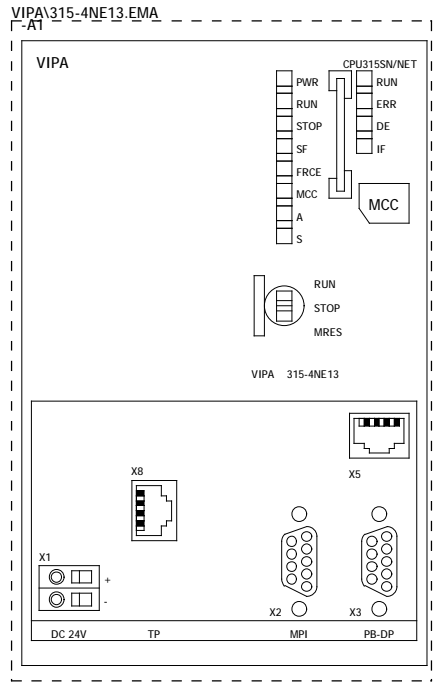

			Datum	08.05.2014	Produktmakros System 300S
			Bearb.	Winkler	
			Gepr		
Anderung	Datum	Name	Urspr		Ersatz von



Frontansicht
CPU 315SN/NET,
315-4NE13

		=
		+ 315_4NE13
		Blatt 2
		Blatt 387

VIPA\315-4NE13.EMA

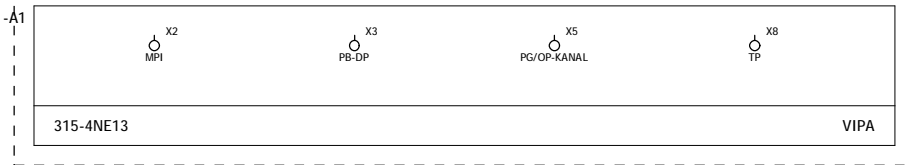

VIPA\315-4NE13.EMA

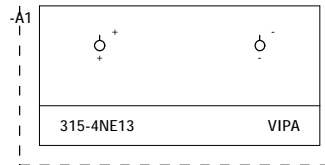

			Datum	08.05.2014	Produktmakros System 300S	YASKAWA	Anschlußbelegung CPU 315SN/NET, 315-4NE13		=	+ 315_4NE13	Blatt	3
			Bearb.	Winkler							Blatt	387
			Gepr									
Anderung	Datum	Name	Urspr		Ersatz von							

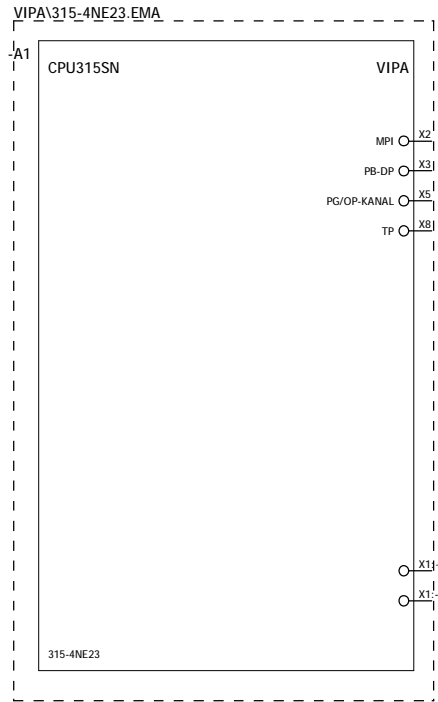

+315_4NE13/3

2

			Datum	19.12.2016	Produktmakros System 300S
			Bearb.	Winkler	
			Gepr		
Anderung	Datum	Name	Urspr		Ersatz von



SPS-Übersicht
CPU 315SN,
315-4NE23

		=
		+ 315_4NE23
	Blatt	1
	Blatt	387

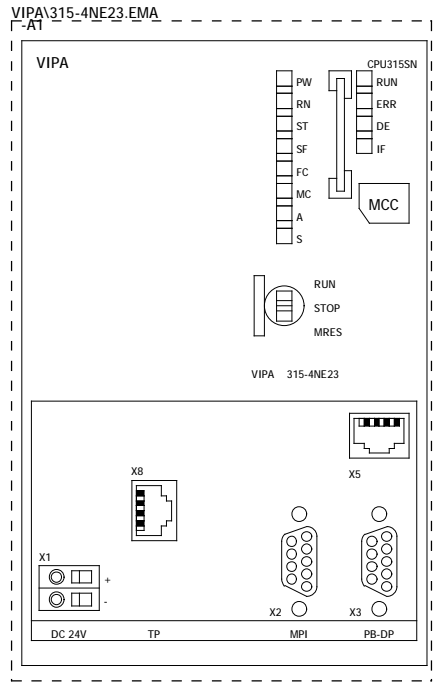

			Datum	20.12.2016	Produktmakros System 300S
			Bearb.	Winkler	
			Gepr		
Anderung	Datum	Name	Urspr		Ersatz von



Frontansicht
CPU 315SN,
315-4NE23

		=
		+ 315_4NE23
		Blatt 2
		Blatt 387

VIPA\315-4NE23.EMA

-A1

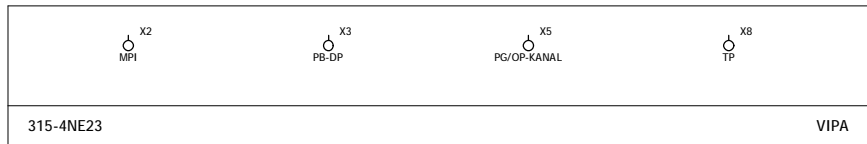

VIPA\315-4NE23.EMA

-A1

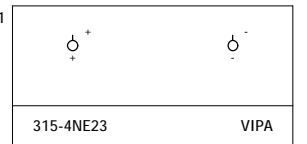

			Datum	19.12.2016	Produktmakros System 300S
			Bearb.	Winkler	
			Gepr.		
Anderung	Datum	Name	Urspr		Ersatz von



Anschlußbelegung
CPU 315SN,
315-4NE23

		=	
		+ 315_4NE23	
			Blatt 3
			Blatt 387

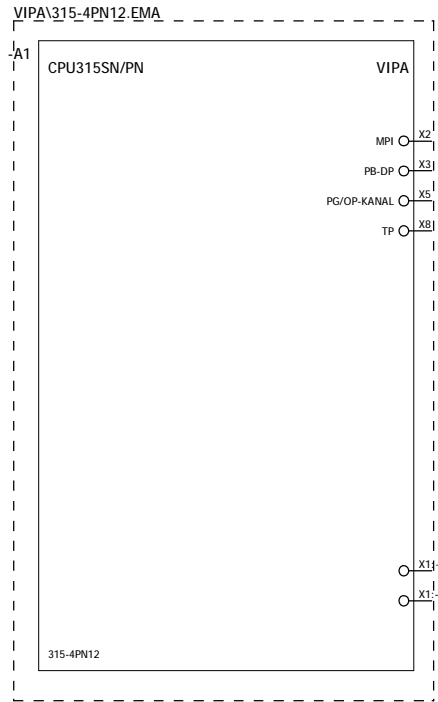

+315_4NE23/3

2

			Datum	08.05.2014	Produktmakros System 300S
			Bearb.	Winkler	
			Gepr		
Anderung	Datum	Name	Urspr		Ersatz von



SPS-Übersicht
CPU 315SN/PN,
315-4PN12

=
+ 315_4PN12

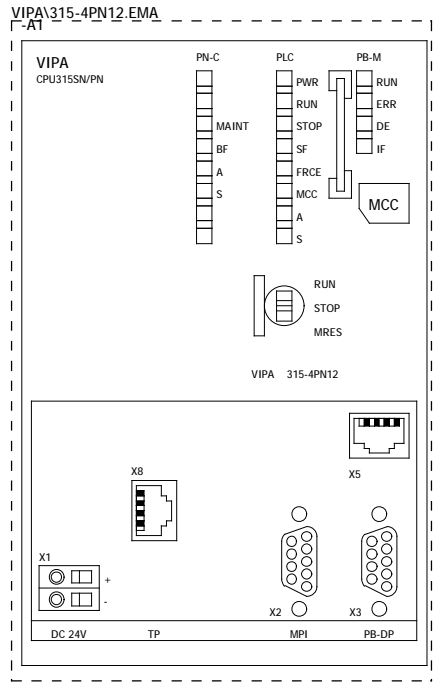

			Datum	29.10.2011	Produktmakros System 300S
			Bearb.	Winkler	
			Gepr		
Anderung	Datum	Name	Urspr		Ersatz von



Frontansicht
CPU 315SN/PN,
315-4PN12

		=
		+ 315_4PN12
		Blatt 2
		Blatt 387

VIPA\315-4PN12.EMA

-A1

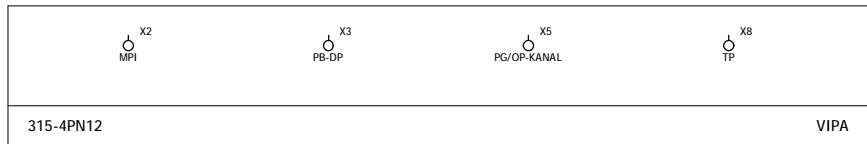

VIPA\315-4PN12.EMA

-A1

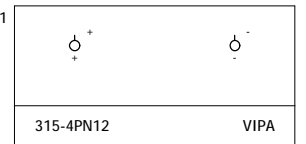

			Datum	08.05.2014	Produktmakros System 300S	YASKAWA	Anschlußbelegung CPU 315SN/PN, 315-4PN12		=	+ 315_4PN12	Blatt 3
			Bearb.	Winkler							
			Gepr.								
Anderung	Datum	Name	Urspr		Ersatz von						Blatt 387

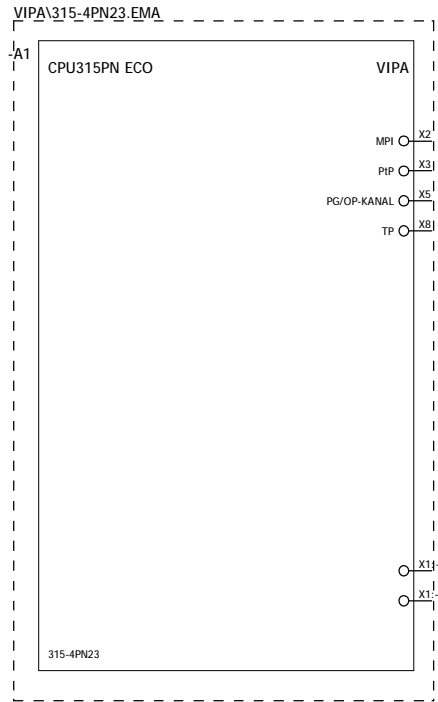

+315_4PN12/3

2

			Datum	19.12.2016	Produktmakros System 300S
			Bearb.	Winkler	
			Gepr		
Anderung	Datum	Name	Urspr		Ersatz von



SPS-Übersicht
CPU 315PN ECO,
315-4PN23

=
+ 315_4PN23

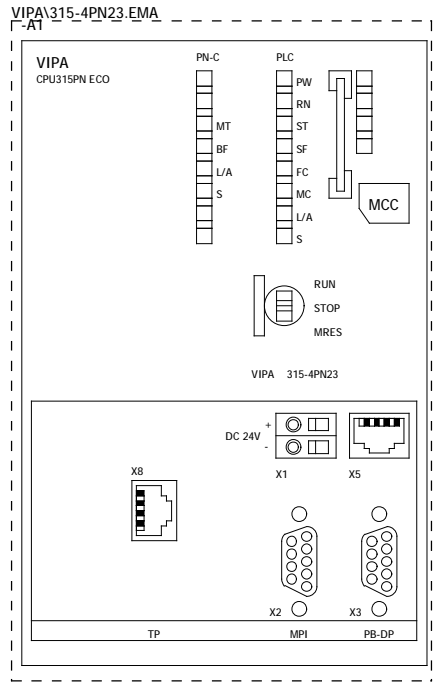

			Datum	19.12.2016	Produktmakros System 300S
			Bearb.	Winkler	
			Gepr.		
Anderung	Datum	Name	Urspr.		Ersatz von



Frontansicht
CPU 315PN ECO,
315-4PN23

		=
		+ 315_4PN23
		Blatt 2
		Blatt 387

VIPA\315-4PN23.EMA

-A1

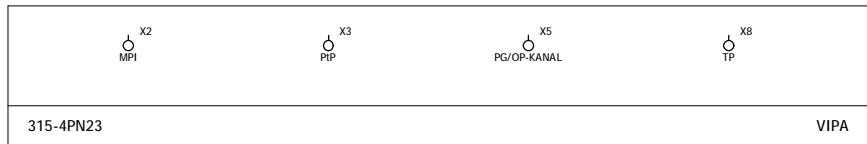

VIPA\315-4PN23.EMA

-A1

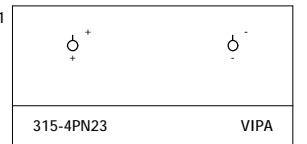

			Datum	19.12.2016	Produktmakros System 300S
			Bearb.	Winkler	
			Gepr.		
Anderung	Datum	Name	Urspr.		Ersatz von



Anschlußbelegung
CPU 315PN ECO,
315-4PN23

		=	
		+ 315_4PN23	
			Blatt 3
			Blatt 387

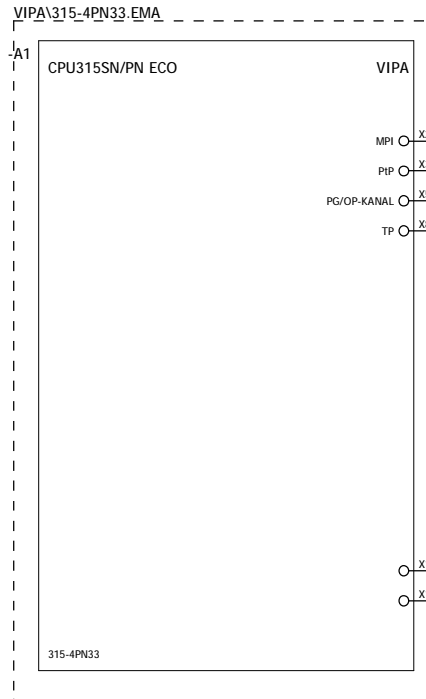

+315_4PN23/3

2

			Datum	08.05.2014	Produktmakros System 300S
			Bearb.	Winkler	
			Gepr		
Anderung	Datum	Name	Urspr		Ersatz von



SPS-Übersicht
CPU 315SN/PN ECO,
315-4PN33

		=
		+ 315_4PN33
	Blatt	1
	Blatt	387

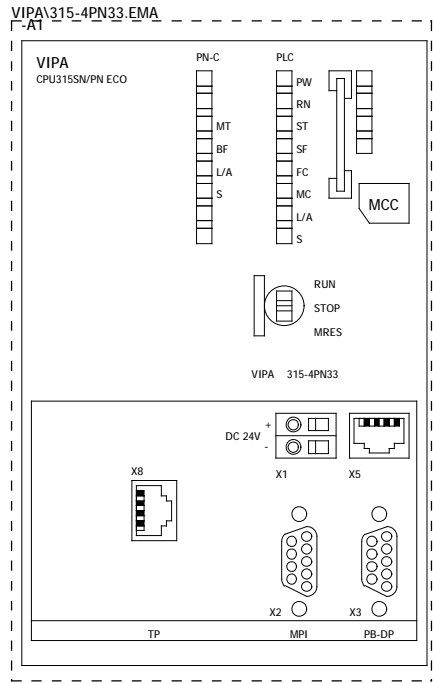

			Datum	08.05.2014	Produktmakros System 300S
			Bearb.	Winkler	
			Gepr.		
Anderung	Datum	Name	Urspr.		Ersatz von



Frontansicht
CPU 315SN/PN ECO,
315-4PN33

		=
		+ 315_4PN33
		Blatt 2
		Blatt 387

VIPA\315-4PN33.EMA

-A1



VIPA\315-4PN33.EMA

-A1

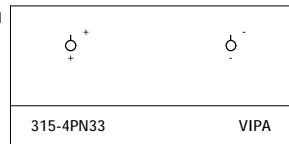

			Datum	08.05.2014	Produktmakros System 300S
			Bearb.	Winkler	
			Gepr.		
Anderung	Datum	Name	Urspr		Ersatz von



Anschlußbelegung
CPU 315SN/PN ECO,
315-4PN33

		=
		+ 315_4PN33
		Blatt 3
		Blatt 387

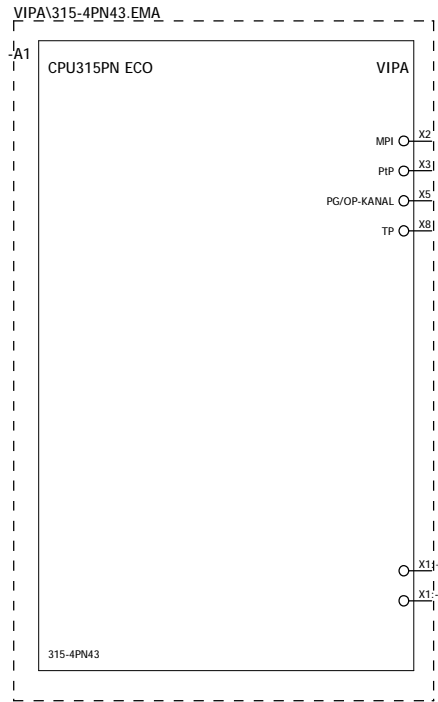

+315_4PN33/3

2

			Datum	19.12.2016	Produktmakros System 300S
			Bearb.	Winkler	
			Gepr		
Anderung	Datum	Name	Urspr		Ersatz von



SPS-Übersicht
CPU 315PN ECO,
315-4PN43

		=
		+ 315_4PN43
		Blatt 1
		Blatt 387

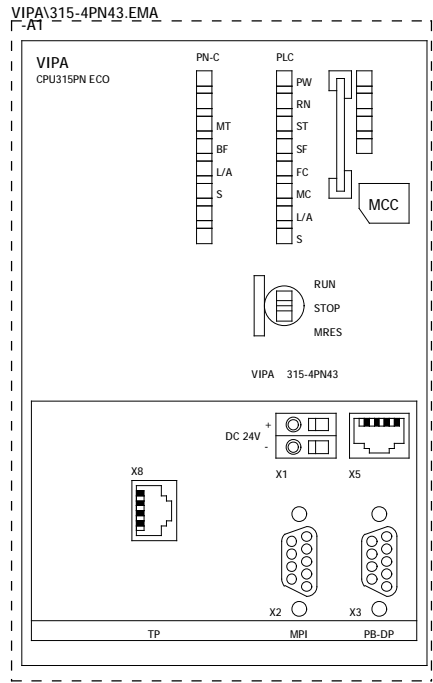

			Datum	19.12.2016	Produktmakros System 300S
			Bearb.	Winkler	
			Gepr		
Anderung	Datum	Name	Urspr		Ersatz von



Frontansicht
CPU 315PN ECO,
315-4PN43

		=
		+ 315_4PN43
		Blatt 2
		Blatt 387

VIPA\315-4PN43.EMA

-A1

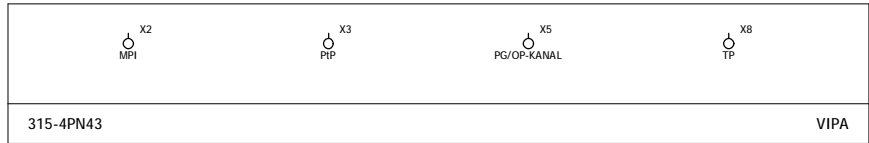

VIPA\315-4PN43.EMA

-A1

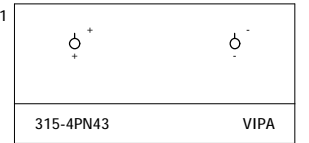

			Datum	19.12.2016	Produktmakros System 300S
			Bearb.	Winkler	
			Gepr.		
Anderung	Datum	Name	Urspr		Ersatz von



Anschlußbelegung
CPU 315PN ECO,
315-4PN43

		=
		+ 315_4PN43
		Blatt 3
		Blatt 387

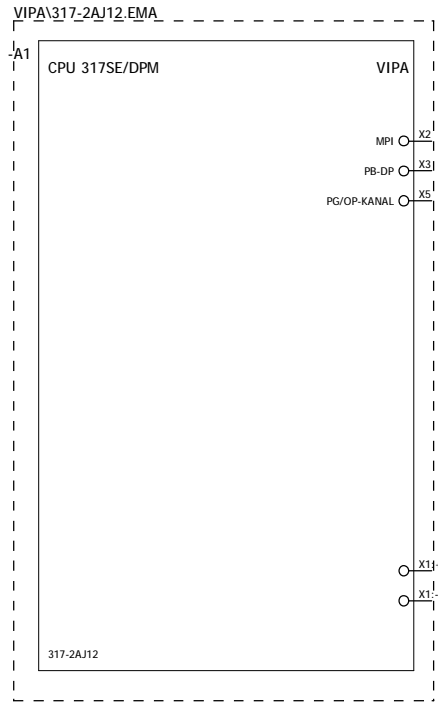

+315_4PN43/3

2

			Datum	08.05.2014	Produktmakros System 300S
			Bearb.	Winkler	
			Gepr		
Anderung	Datum	Name	Urspr		Ersatz von



SPS-Übersicht
CPU 317SE/DPM,
317-2AJ12

=
+ 317_2AJ12

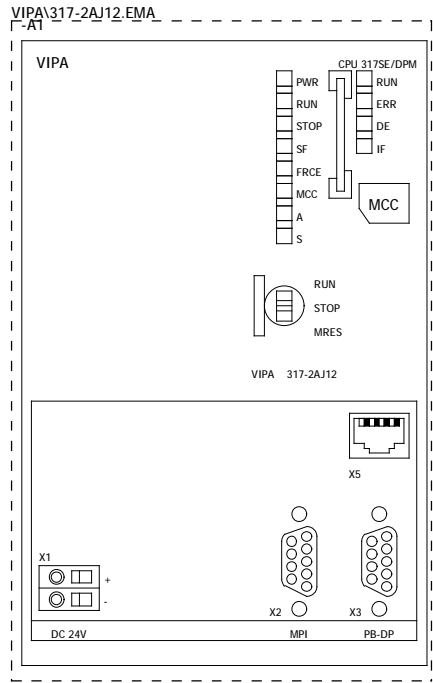

			Datum	29.11.2010	Produktmakros System 300S
			Bearb.	Winkler	
			Gepr.		
Anderung	Datum	Name	Urspr.		Ersatz von



Frontansicht
CPU 317SE/DPM,
317-2AJ12

		=
		+ 317_2AJ12
		Blatt 2
		Blatt 387

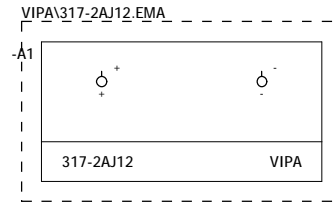
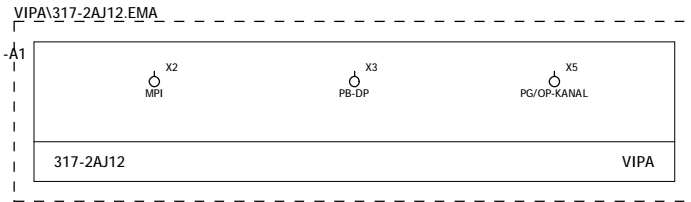

			Datum	08.05.2014	Produktmakros System 300S
			Bearb.	Winkler	
			Gepr.		
Anderung	Datum	Name	Urspr.		Ersatz von



Anschlußbelegung
CPU 317SE/DPM,
317-2AJ12

		=
		+ 317_2AJ12
	Blatt	3
	Blatt	387

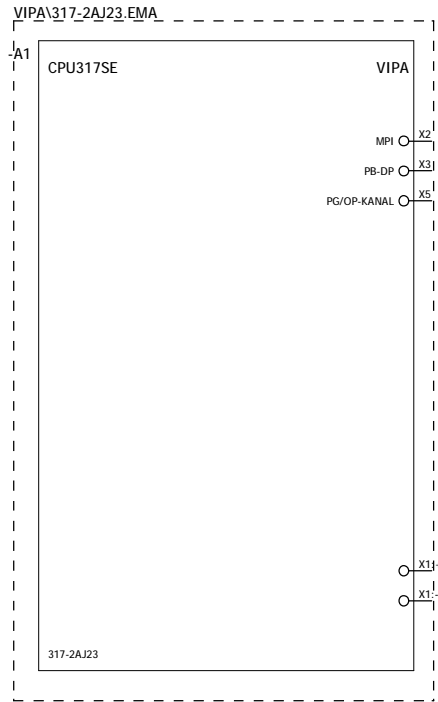

+317_2AJ12/3

2

			Datum	19.12.2016	Produktmakros System 300S
			Bearb.	Winkler	
			Gepr		
Anderung	Datum	Name	Urspr		Ersatz von



SPS-Übersicht
CPU 317SE,
317-2AJ23

=
+ 317_2AJ23

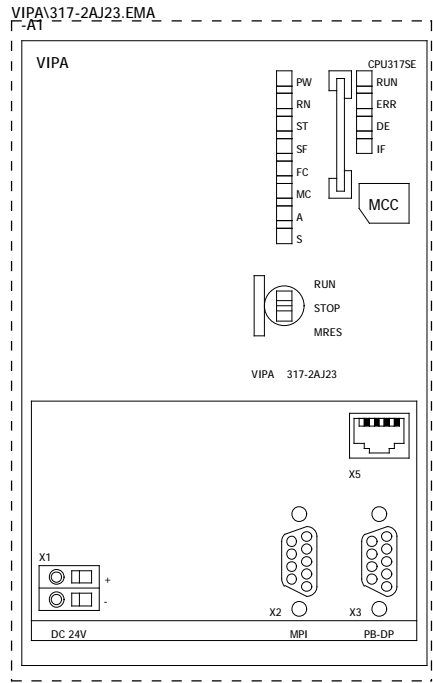

			Datum	20.12.2016	Produktmakros System 300S
			Bearb.	Winkler	
			Gepr.		
Anderung	Datum	Name	Urspr		Ersatz von



Frontansicht
CPU 317SE,
317-2AJ23

		=
		+ 317_2AJ23
		Blatt 2
		Blatt 387

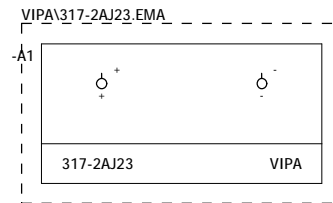
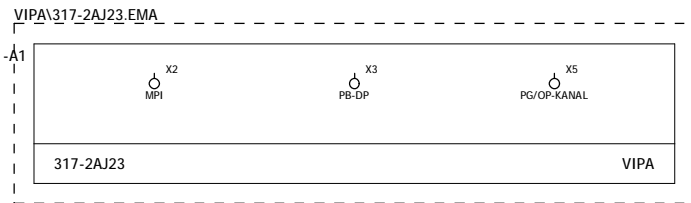

			Datum	19.12.2016	Produktmakros System 300S	YASKAWA	Anschlußbelegung CPU 317SE, 317-2AJ23	=	
			Bearb.	Winkler				+ 317_2AJ23	
			Gepr.					Blatt	3
Anderung	Datum	Name	Urspr		Ersatz von			Blatt	387

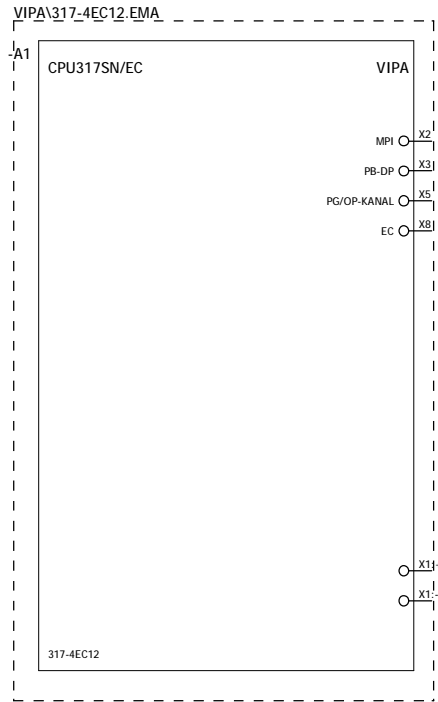

+317_2AJ23/3

2

			Datum	08.05.2014	Produktmakros System 300S
			Bearb.	Winkler	
			Gepr		
Anderung	Datum	Name	Urspr		Ersatz von



SPS-Übersicht
CPU 317SN/EC,
317-4EC12

=
+ 317_4EC12

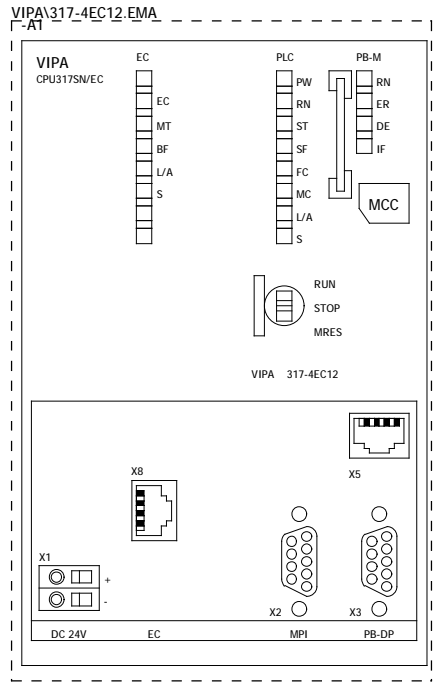

			Datum	08.05.2014	Produktmakros System 300S
			Bearb.	Winkler	
			Gepr.		
Anderung	Datum	Name	Urspr.		Ersatz von



Frontansicht
CPU 317SN/EC,
317-4EC12

		=
		+ 317_4EC12
		Blatt 2
		Blatt 387

VIPA\317-4EC12.EMA

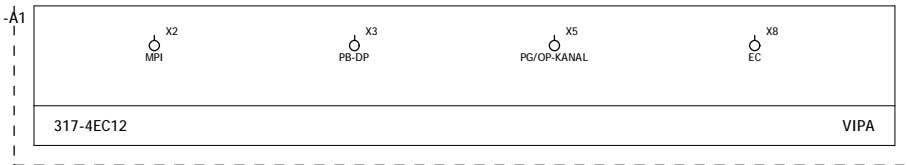

VIPA\317-4EC12.EMA

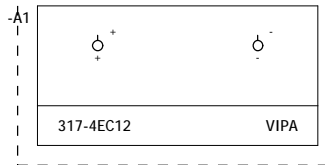

			Datum	08.05.2014	Produktmakros System 300S
			Bearb.	Winkler	
			Gepr.		
Anderung	Datum	Name	Urspr		Ersatz von



Anschlußbelegung
CPU 317SN/EC,
317-4EC12

		=	
		+ 317_4EC12	
			Blatt 3
			Blatt 387

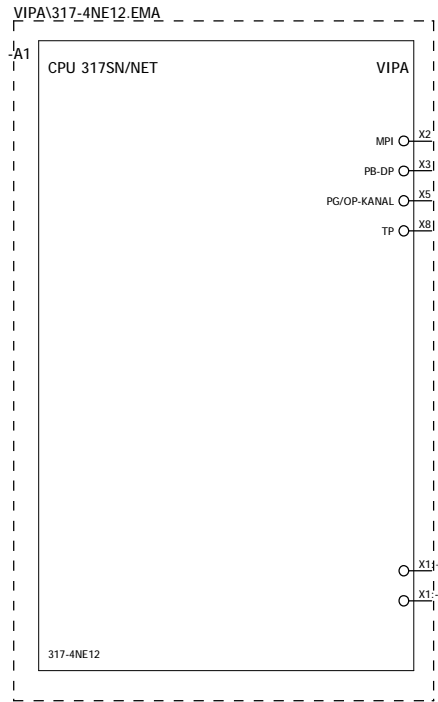

+317_4EC12/3

2

			Datum	08.05.2014	Produktmakros System 300S
			Bearb.	Winkler	
			Gepr		
Anderung	Datum	Name	Urspr		Ersatz von



SPS-Übersicht
CPU 317SN/NET,
317-4NE12

		=
		+ 317_4NE12
		Blatt 1
		Blatt 387

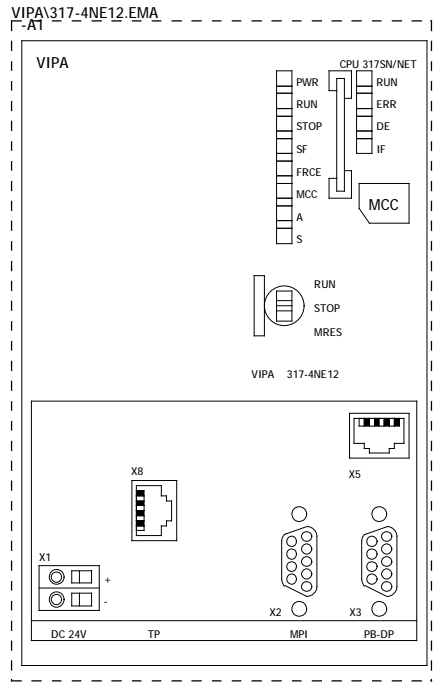

			Datum	29.11.2010	Produktmakros System 300S
			Bearb.	Winkler	
			Gepr		
Anderung	Datum	Name	Urspr		Ersatz von



Frontansicht
CPU 317SN/NET,
317-4NE12

		=
		+ 317_4NE12
		Blatt 2
		Blatt 387

VIPA\317-4NE12.EMA

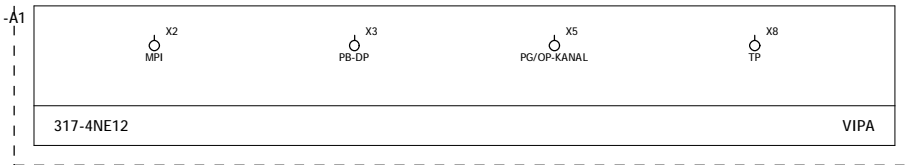

VIPA\317-4NE12.EMA

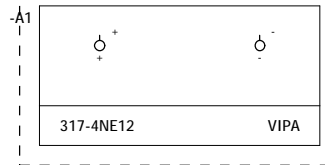

			Datum	08.05.2014	Produktmakros System 300S
			Bearb.	Winkler	
			Gepr.		
Anderung	Datum	Name	Urspr		Ersatz von



Anschlußbelegung
CPU 317SN/NET,
317-4NE12

		=	
		+ 317_4NE12	
			Blatt 3
			Blatt 387

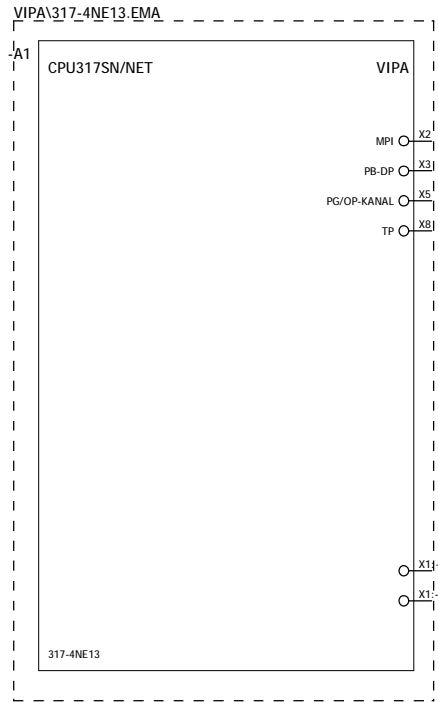

+317_4NE12/3

			Datum	08.05.2014	Produktmakros System 300S	YASKAWA	SPS-Übersicht CPU 317SN/NET, 317-4NE13		=	+ 317_4NE13	Blatt	1
			Bearb.	Winkler								
			Gepr									
Anderung	Datum	Name	Urspr		Ersatz von						Blatt	387

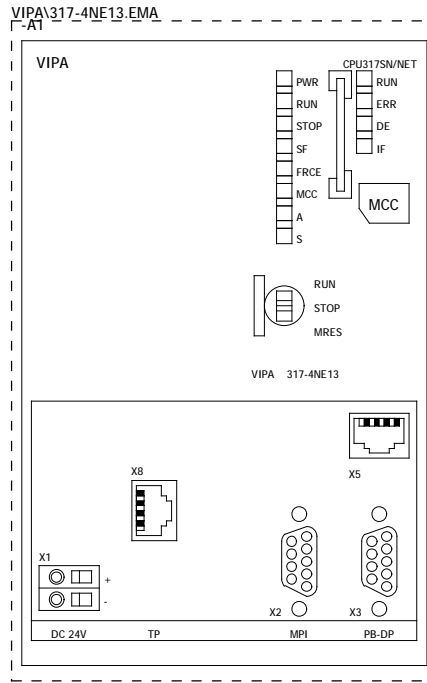

			Datum	08.05.2014	Produktmakros System 300S
			Bearb.	Winkler	
			Gepr		
Anderung	Datum	Name	Urspr		Ersatz von



Frontansicht
CPU 317SN/NET,
317-4NE13

		=
		+ 317_4NE13
		Blatt 2
		Blatt 387

VIPA\317-4NE13.EMA

-A1

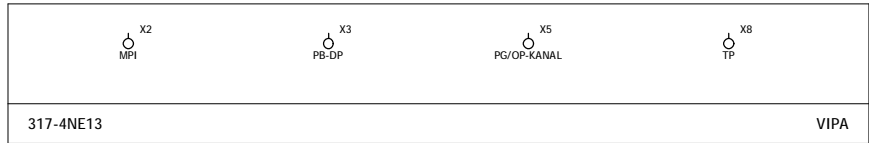

VIPA\317-4NE13.EMA

-A1

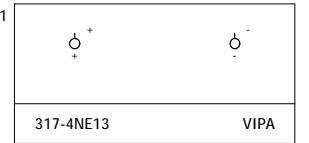

			Datum	08.05.2014	Produktmakros System 300S
			Bearb.	Winkler	
			Gepr		
Anderung	Datum	Name	Urspr		Ersatz von



Anschlußbelegung
CPU 317SN/NET,
317-4NE13

		=	
		+ 317_4NE13	
			Blatt 3
			Blatt 387

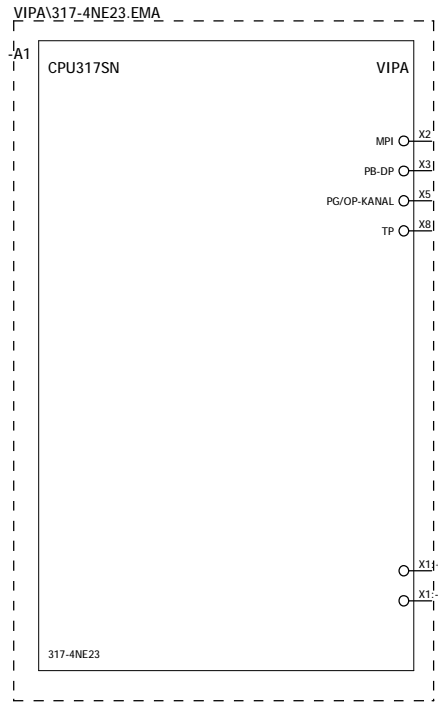

+317_4NE13/3

2

			Datum	19.12.2016	Produktmakros System 300S
			Bearb.	Winkler	
			Gepr		
Anderung	Datum	Name	Urspr		Ersatz von



SPS-Übersicht
CPU 317SN,
317-4NE23

		=
		+ 317_4NE23
	Blatt	1
	Blatt	387

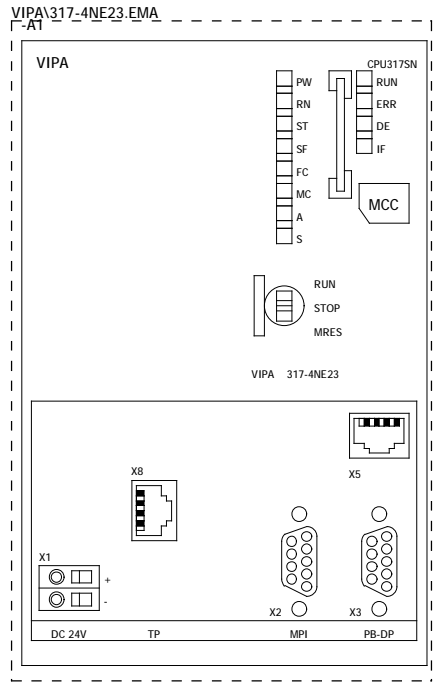

			Datum	20.12.2016	Produktmakros System 300S
			Bearb.	Winkler	
			Gepr.		
Anderung	Datum	Name	Urspr.		Ersatz von



Frontansicht
CPU 317SN,
317-4NE23

		=
		+ 317_4NE23
		Blatt 2
		Blatt 387

VIPA\317-4NE23.EMA

-A1

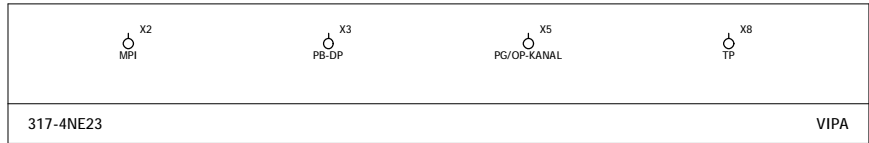

317-4NE23

VIPA

VIPA\317-4NE23.EMA

-A1

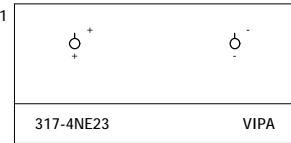

317-4NE23

VIPA

			Datum	19.12.2016	Produktmakros System 300S
			Bearb.	Winkler	
			Gepr.		
Anderung	Datum	Name	Urspr.		Ersatz von



Anschlußbelegung
CPU 317SN,
317-4NE23

		=	
		+ 317_4NE23	
			Blatt 3
			Blatt 387

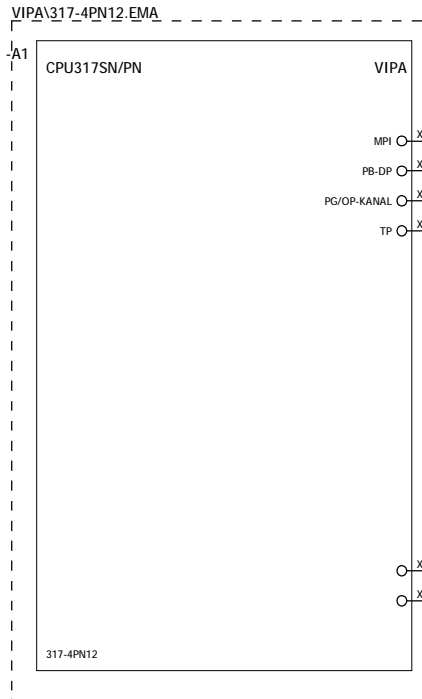

+317_4NE23/3

			Datum	08.05.2014	Produktmakros System 300S
			Bearb.	Winkler	
			Gepr		
Anderung	Datum	Name	Urspr		Ersatz von



SPS-Übersicht
CPU 317SN/PN,
317-4PN12

		=
		+ 317_4PN12
		Blatt 1
		Blatt 387

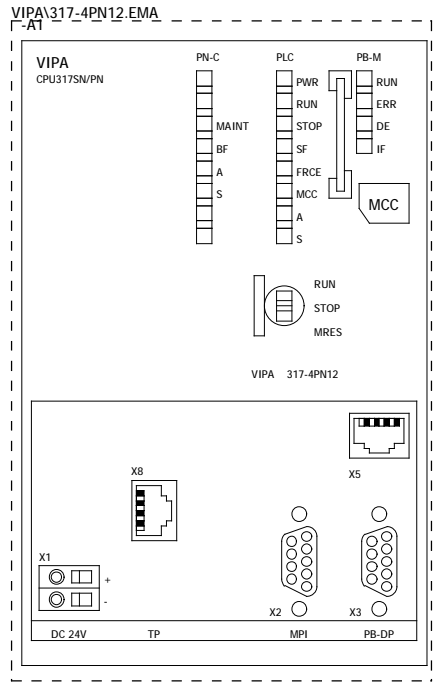

			Datum	29.10.2011	Produktmakros System 300S
			Bearb.	Winkler	
			Gepr		
Anderung	Datum	Name	Urspr		Ersatz von



Frontansicht
CPU 317SN/PN,
317-4PN12

		=
		+ 317_4PN12
		Blatt 2
		Blatt 387

VIPA\317-4PN12.EMA

-A1

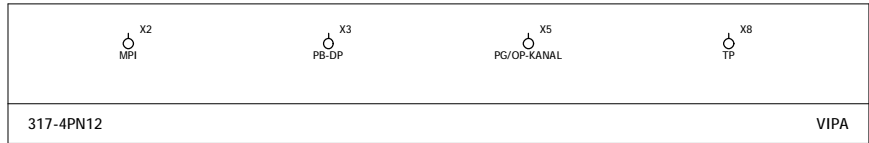

VIPA\317-4PN12.EMA

-A1

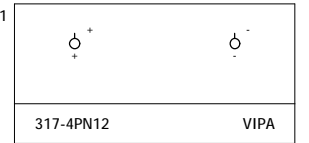

			Datum	08.05.2014	Produktmakros System 300S
			Bearb.	Winkler	
			Gepr.		
Anderung	Datum	Name	Urspr.		Ersatz von



Anschlußbelegung
CPU 317SN/PN,
317-4PN12

		=
		+ 317_4PN12
		Blatt 3
		Blatt 387

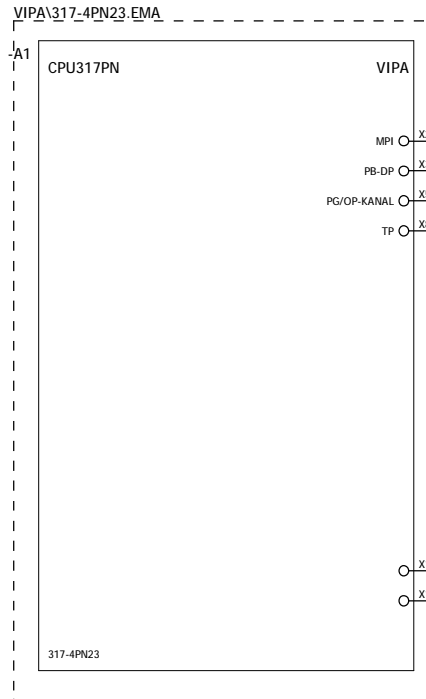

+317_4PN12/3

2

			Datum	19.12.2016	Produktmakros System 300S
			Bearb.	Winkler	
			Gepr		
Anderung	Datum	Name	Urspr		Ersatz von



SPS-Übersicht
CPU 317PN,
317-4PN23

		=
		+ 317_4PN23
	Blatt	1
	Blatt	387

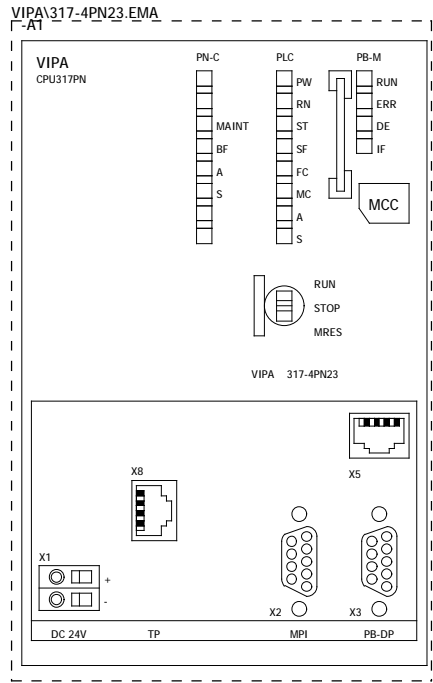

			Datum	20.12.2016	Produktmakros System 300S
			Bearb.	Winkler	
			Gepr.		
Anderung	Datum	Name	Urspr.		Ersatz von



Frontansicht
CPU 317PN,
317-4PN23

		=
		+ 317_4PN23
		Blatt 2
		Blatt 387

VIPA\317-4PN23.EMA

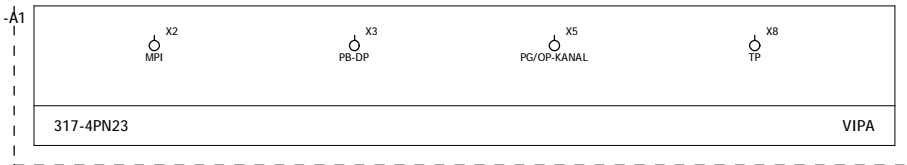

VIPA\317-4PN23.EMA

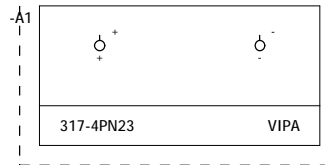

			Datum	19.12.2016	Produktmakros System 300S
			Bearb.	Winkler	
			Gepr.		
Anderung	Datum	Name	Urspr.		Ersatz von



Anschlußbelegung
CPU 317PN,
317-4PN23

		=	
		+ 317_4PN23	
			Blatt 3
			Blatt 387

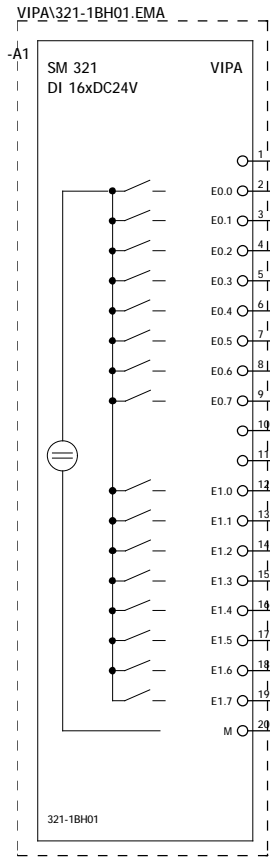

			Datum	08.05.2014	Produktmakros System 300S
			Bearb.	Winkler	
			Gepr		
Anderung	Datum	Name	Urspr		Ersatz von



		=
		+ 321_1BH01
		Blatt 1
		Blatt 387

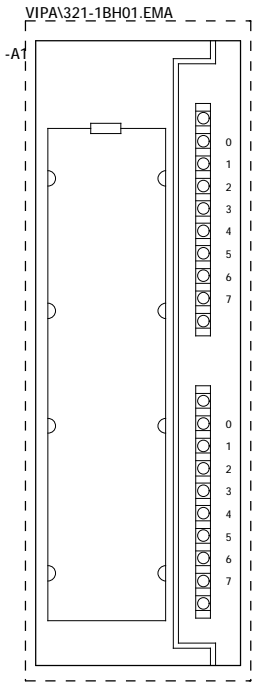

		Datum	30.11.2010	Produktmakros System 300S
		Bearb.	Winkler	
		Gepr		
Anderung	Datum	Name	Urspr	Ersatz von



Frontansicht
SM 321 DI 16xDC24V
321-1BH01

		=	
		+ 321_1BH01	
			Blatt 2
			Blatt 387

VIPA\321-1BH01.EMA

A1

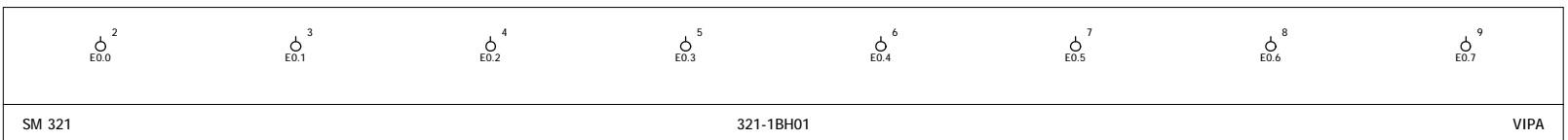

			Datum	08.05.2014	Produktmakros System 300S	YASKAWA	Eingangsbyte 0 SM 321 DI 16xDC24V 321-1BH01		=	+ 321_1BH01	Blatt 3
			Bearb.	Winkler							
			Gepr								
Anderung	Datum	Name	Urspr		Ersatz von						Blatt 387

VIPA\321-1BH01.EMA

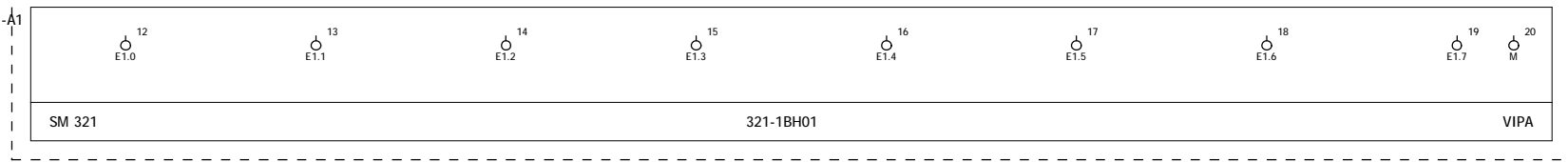

3

+321_1BH70/1

			Datum	08.05.2014	Produktmakros System 300S	YASKAWA	Eingangsbyte 1 SM 321 DI 16xDC24V 321-1BH01		=	+ 321_1BH01	Blatt 4
			Bearb.	Winkler							
			Gepr								
Anderung	Datum	Name	Urspr		Ersatz von						Blatt 387

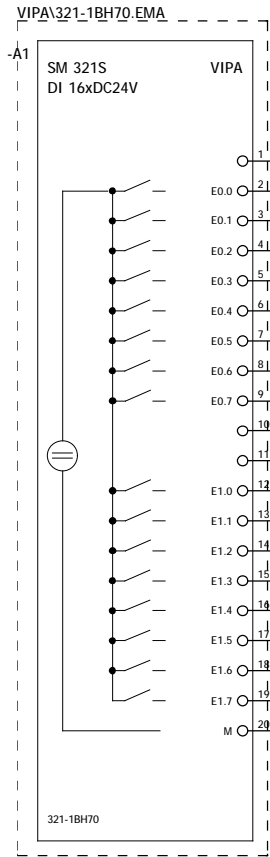

+321_1BH01/4

		Datum	08.05.2014	Produktmakros System 300S
		Bearb.	Winkler	
		Gepr		
Anderung	Datum	Name	Urspr	Ersatz von



SPS-Übersicht
SM 321S DI 16xDC 24V,
321-1BH70

		=
		+ 321_1BH70
		Blatt 1
		Blatt 387

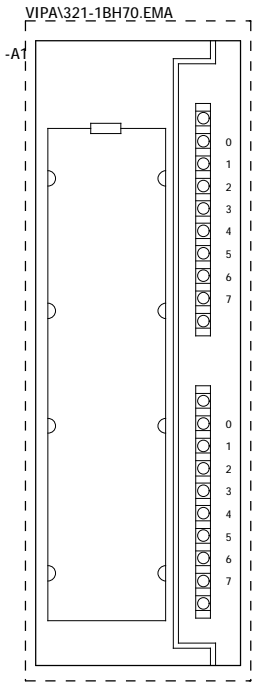

			Datum	30.11.2010	Produktmakros System 300S
			Bearb.	Winkler	
			Gepr		
Anderung	Datum	Name	Urspr		Ersatz von



Frontansicht
SM 321S DI 16xDC 24V,
321-1BH70

		=
		+ 321_1BH70
		Blatt 2
		Blatt 387

VIPA\321-1BH70.EMA

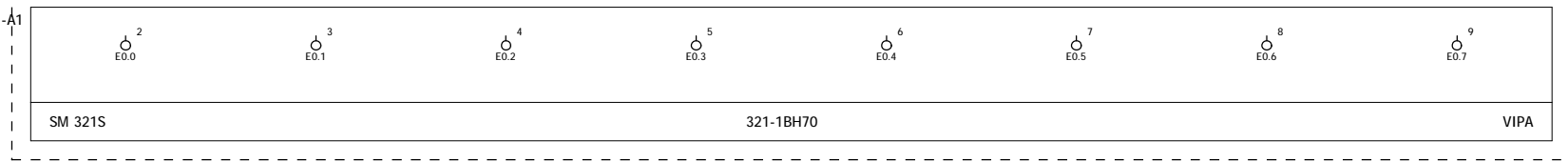

			Datum	08.05.2014	Produktmakros System 300S	YASKAWA	Eingangsbyte 0 SM 321S DI 16xDC 24V, 321-1BH70		=	+ 321_1BH70	Blatt	3
			Bearb.	Winkler								
			Gepr									
Anderung	Datum	Name	Urspr		Ersatz von						Blatt	387

VIPA\321-1BH70.EMA

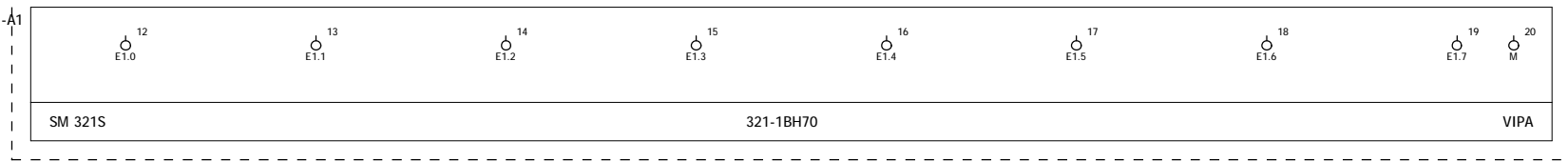

3

+321_1BL00/1

			Datum	08.05.2014	Produktmakros System 300S	YASKAWA	Eingangsbyte 1 SM 321S DI 16xDC 24V, 321-1BH70		=	+ 321_1BH70	Blatt	4
			Bearb.	Winkler							Blatt	387
			Gepr									
Anderung	Datum	Name	Urspr		Ersatz von							

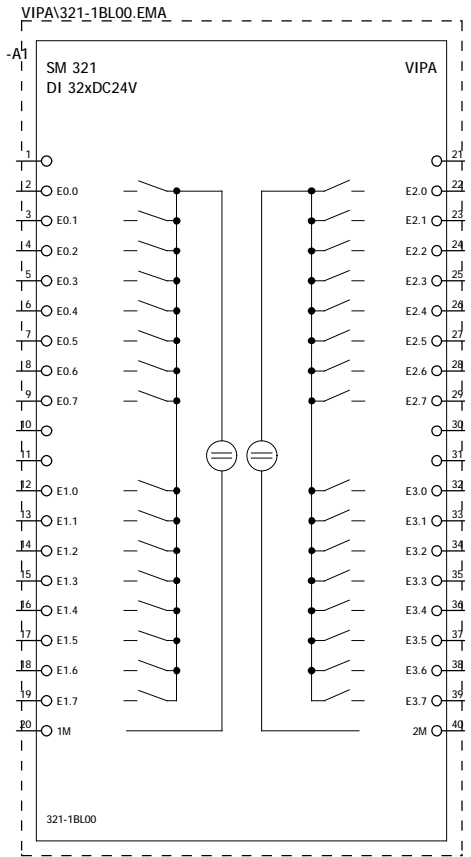

+321_1BH70/4

			Datum	08.05.2014	Produktmakros System 300S
			Bearb.	Winkler	
			Gepr		
Anderung	Datum	Name	Urspr		Ersatz von



SPS-Übersicht
SM 321 DI 32xDC24V
321-1BL00

		=
		+ 321_1BL00
		Blatt 1
		Blatt 387

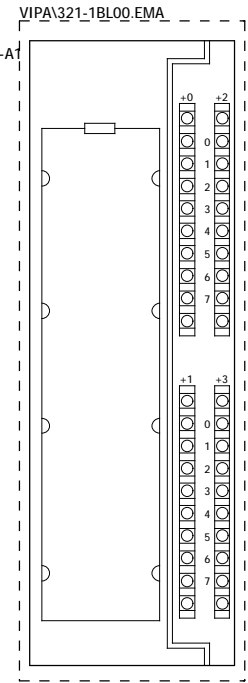

		Datum	30.11.2010	Produktmakros System 300S
		Bearb.	Winkler	
		Gepr		
Anderung	Datum	Name	Urspr	Ersatz von



Frontansicht
SM 321 DI 32xDC24V
321-1BL00

		=	
		+ 321_1BL00	
			Blatt 2
			Blatt 387

VIPA\321-1BL00.EMA

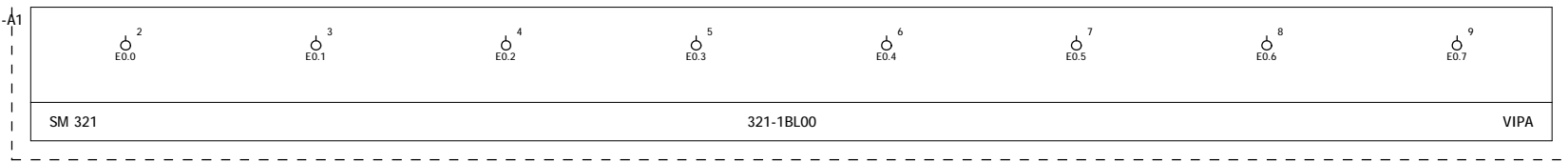

			Datum	08.05.2014	Produktmakros System 300S	YASKAWA	Eingangsbyte 0 SM 321 DI 16xDC24V 321-1BL00		=	+ 321_1BL00	Blatt 3
			Bearb.	Winkler							
			Gepr								
Anderung	Datum	Name	Urspr		Ersatz von						Blatt 387

VIPA\321-1BL00.EMA

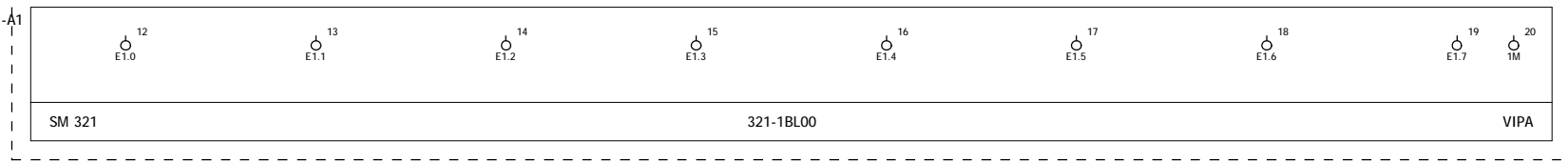

			Datum	08.05.2014	Produktmakros System 300S	YASKAWA	Eingangsbyte 1 SM 321 DI 16xDC24V 321-1BL00		=	+ 321_1BL00	Blatt	4
			Bearb.	Winkler								
			Gepr									
Anderung	Datum	Name	Urspr		Ersatz von						Blatt	387

VIPA\321-1BL00.EMA

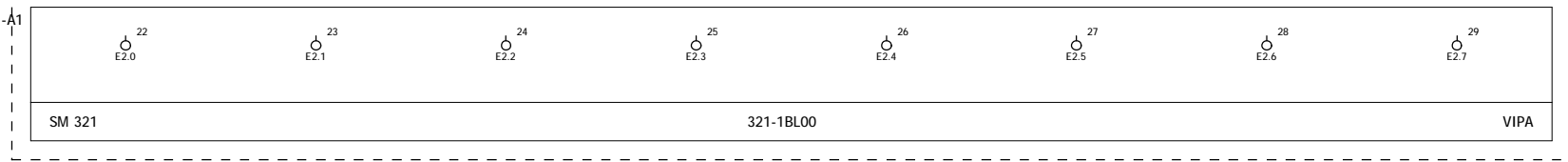

			Datum	08.05.2014	Produktmakros System 300S	YASKAWA	Eingangsbyte 2 SM 321 DI 16xDC24V 321-1BL00	=	+ 321_1BL00	Blatt	5
			Bearb.	Winkler							
			Gepr								
Anderung	Datum	Name	Urspr		Ersatz von					Blatt	387

VIPA\321-1BL00.EMA

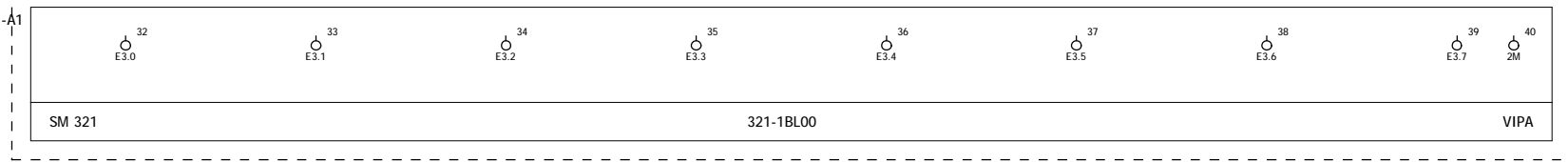

			Datum	08.05.2014	Produktmakros System 300S	YASKAWA	Eingangsbyte 3 SM 321 DI 16xDC24V 321-1BL00		=	+ 321_1BL00	Blatt 6
			Bearb.	Winkler							
			Gepr								
Anderung	Datum	Name	Urspr		Ersatz von						Blatt 387

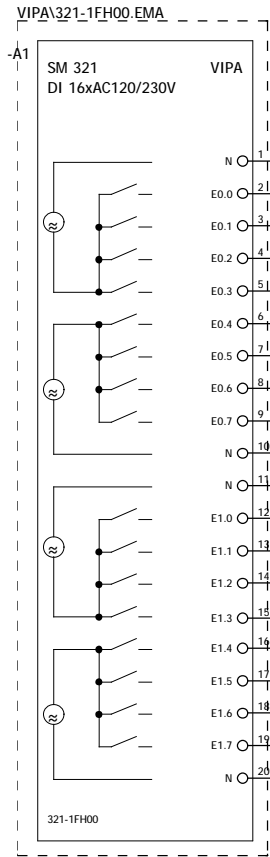

+321_1BL00/6

			Datum	08.05.2014	Produktmakros System 300S
			Bearb.	Winkler	
			Gepr		
Anderung	Datum	Name	Urspr		Ersatz von



SPS-Übersicht
SM 321 DI 16xAC120/230V
321-1FH00

		=
		+ 321_1FH00
	Blatt	1
	Blatt	387

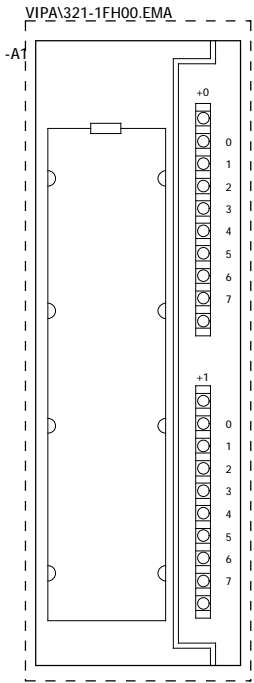

			Datum	30.11.2010	Produktmakros System 300S
			Bearb.	Winkler	
			Gepr		
Anderung	Datum	Name	Urspr		Ersatz von



Frontansicht
SM 321 DI 16xAC120/230V
321-1FH00

		=
		+ 321_1FH00
		Blatt 2
		Blatt 387

VIPA\321-1FH00.EMA

A1

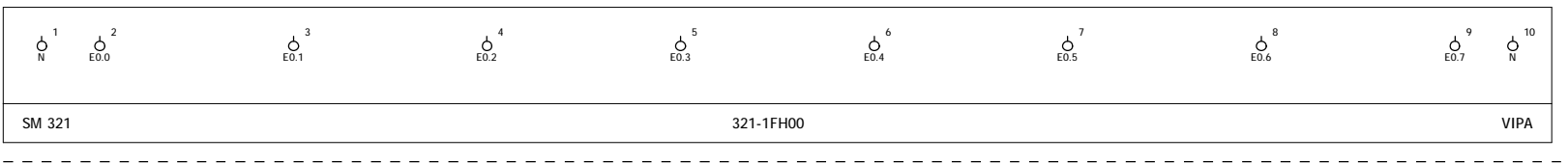

			Datum	08.05.2014	Produktmakros System 300S	YASKAWA	Eingangsbyte 0 SM 321 DI 16xAC120/230V 321-1FH00	=	+ 321_1FH00	Blatt	3
			Bearb.	Winkler							
			Gepr								
Anderung	Datum	Name	Urspr		Ersatz von					Blatt	387

VIPA\321-1FH00.EMA

A1

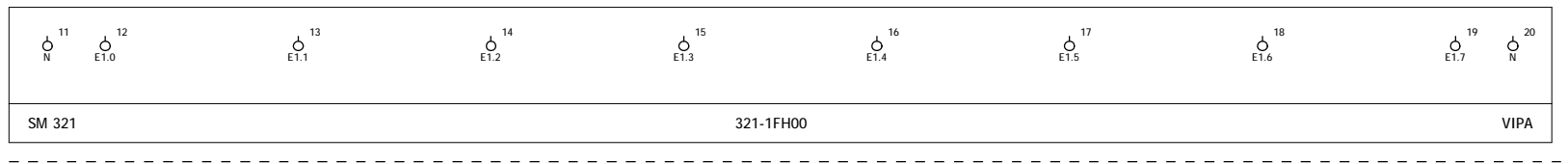

			Datum	08.05.2014	Produktmakros System 300S
			Bearb.	Winkler	
			Gepr		
Anderung	Datum	Name	Urspr		Ersatz von



Eingangsbyte 1
SM 321 DI 16xAC120/230V
321-1FH00

		=
		+ 321_1FH00
	Blatt	4
	Blatt	387

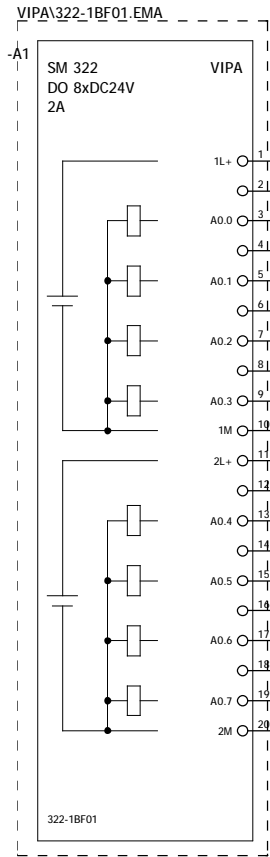

+321_1FH00/4

			Datum	08.05.2014	Produktmakros System 300S
			Bearb.	Winkler	
			Gepr.		
Anderung	Datum	Name	Urspr.		Ersatz von



SPS-Übersicht
322 8xDO DC24V/2A
322-1BF01

		=
		+ 322_1BF01
	Blatt	1
	Blatt	387

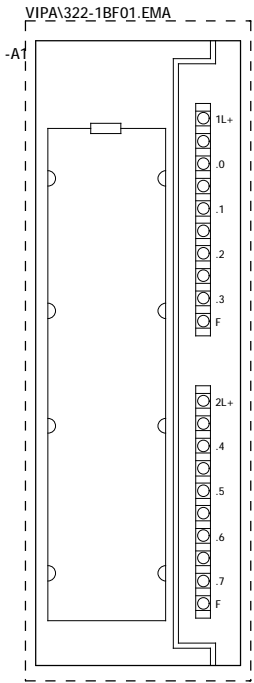

			Datum	30.11.2010	Produktmakros System 300S
			Bearb.	Winkler	
			Gepr		
Anderung	Datum	Name	Urspr		Ersatz von



Frontansicht
322 8xDO DC24V/2A
322-1BF01

		=
		+ 322_1BF01
		Blatt 2
		Blatt 387

VIPA\322-1BF01.EMA

A1

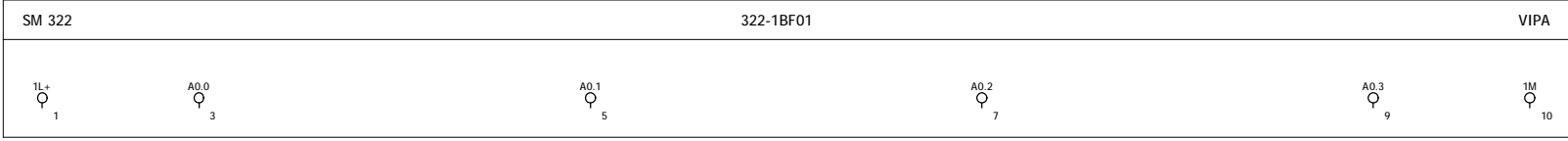

			Datum	08.05.2014	Produktmakros System 300S	YASKAWA	Ausgangsbyte 0 322 8xDO DC24V/2A 322-1BF01	=	+ 322_1BF01	Blatt 3
			Bearb.	Winkler						
			Gepr.							
Anderung	Datum	Name	Urspr.		Ersatz von					Blatt 387

VIPA\322-1BF01.EMA

A1

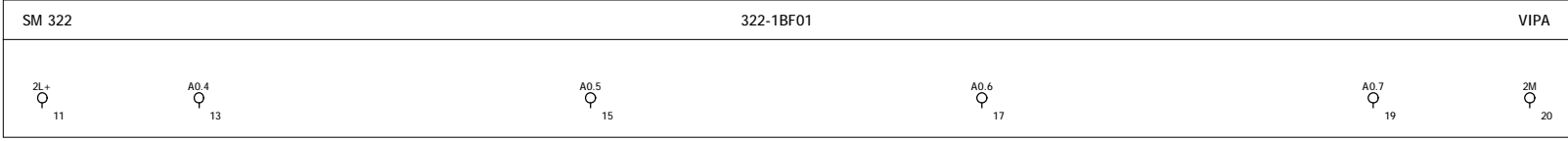

3

+322_1BH01/1

			Datum	08.05.2014	Produktmakros System 300S
			Bearb.	Winkler	
			Gepr		
Anderung	Datum	Name	Urspr		Ersatz von



Ausgangsbyte 0
322 8xDO DC24V/2A
322-1BF01

		=	
		+ 322_1BF01	
		Blatt	4
		Blatt	387

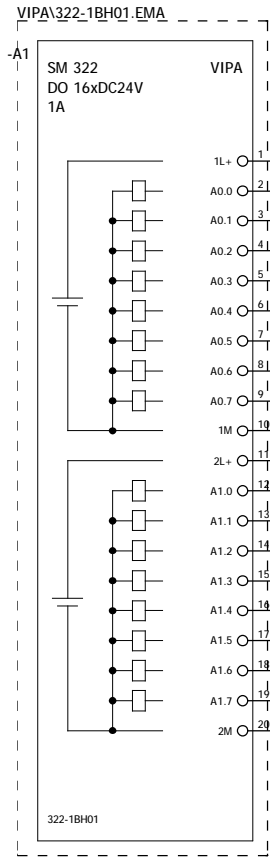

+322_1BF01/4

			Datum	08.05.2014	Produktmakros System 300S
			Bearb.	Winkler	
			Gepr		
Anderung	Datum	Name	Urspr		Ersatz von



SPS-Übersicht
322 16xDO DC24V/1A
322-1BH01

		=
		+ 322_1BH01
		Blatt 1
		Blatt 387

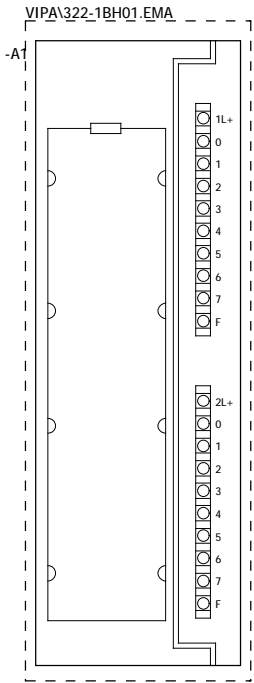

		Datum	30.11.2010	Produktmakros System 300S
		Bearb.	Winkler	
		Gepr		
Anderung	Datum	Name	Urspr	Ersatz von



Frontansicht
322 16xDO DC24V/1A
322-1BH01

		=
		+ 322_1BH01
		Blatt 2
		Blatt 387

VIPA\322-1BH01.EMA

A1

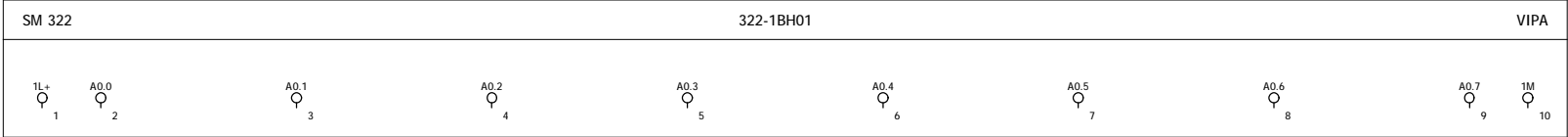

			Datum	08.05.2014	Produktmakros System 300S	YASKAWA	Ausgangsbyte 0 322 16xDO DC24V/1A 322-1BH01	=	+ 322_1BH01	Blatt	3	
			Bearb.	Winkler							Blatt	387
			Gepr									
Anderung	Datum	Name	Urspr		Ersatz von							

VIPA\322-1BH01.EMA

A1

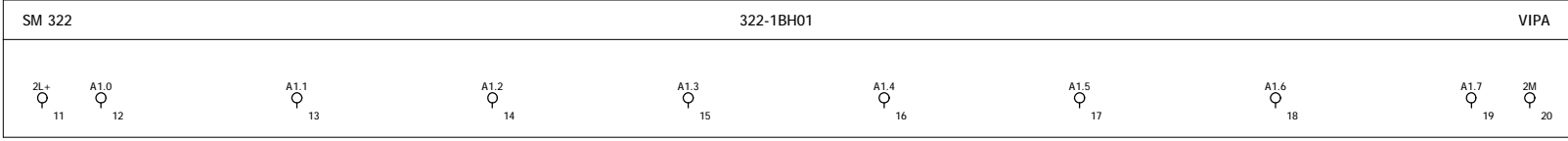

3

+322_1BH41/1

			Datum	08.05.2014	Produktmakros System 300S	YASKAWA	Ausgangsbyte 1 322 16xDO DC24V/1A 322-1BH01		=	+ 322_1BH01	Blatt	4
			Bearb.	Winkler							Blatt	387
			Gepr									
Anderung	Datum	Name	Urspr		Ersatz von							

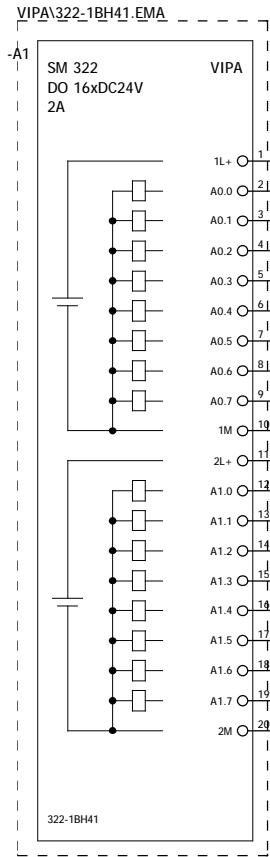

+322_1BH01/4

			Datum	08.05.2014	Produktmakros System 300S
			Bearb.	Winkler	
			Gepr		
Anderung	Datum	Name	Urspr		Ersatz von



SPS-Übersicht
322 16xDO DC24V/2A
322-1BH41

		=
		+ 322_1BH41
		Blatt 1
		Blatt 387

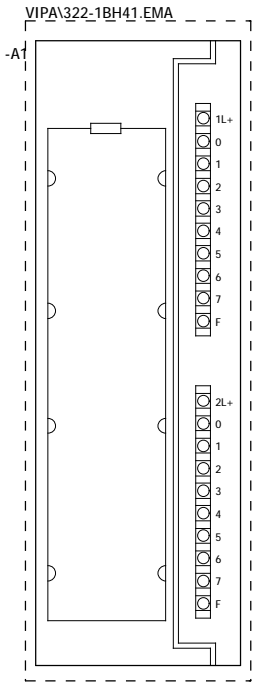

			Datum	30.11.2010	Produktmakros System 300S
			Bearb.	Winkler	
			Gepr		
Anderung	Datum	Name	Urspr		Ersatz von



Frontansicht
322 16xDO DC24V/2A
322-1BH41

		=
		+ 322_1BH41
		Blatt 2
		Blatt 387

VIPA\322-1BH41.EMA

A1

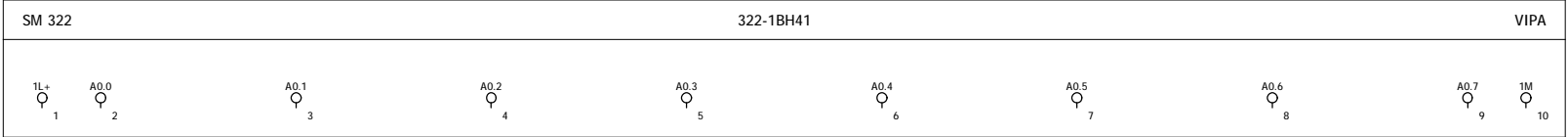

			Datum	08.05.2014	Produktmakros System 300S		Ausgangsbyte 0	=	+ 322_1BH41	Blatt 3
			Bearb.	Winkler			322 16xDO DC24V/2A			
			Gepr				322-1BH41			
Anderung	Datum	Name	Urspr		Ersatz von					Blatt 387

VIPA\322-1BH41.EMA

A1

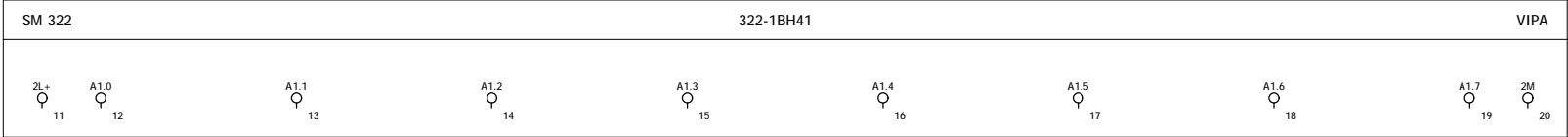

3

+322_1BH60/1

			Datum	08.05.2014	Produktmakros System 300S	YASKAWA	Ausgangsbyte 1 322 16xDO DC24V/2A 322-1BH41		=	+ 322_1BH41	Blatt	4
			Bearb.	Winkler							Blatt	387
			Gepr									
Anderung	Datum	Name	Urspr		Ersatz von							

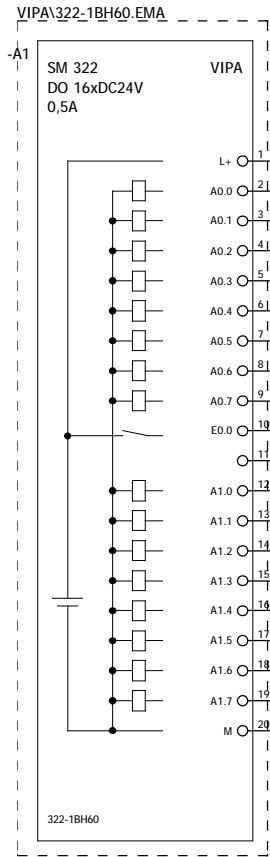

+322_1BH41/4

		Datum	08.05.2014	Produktmakros System 300S
		Bearb.	Winkler	
		Gepr		
Anderung	Datum	Name	Urspr	Ersatz von



SPS-Übersicht
322 16xDO DC24V/0,5A
322-1BH60

		=
		+ 322_1BH60
		Blatt 1
		Blatt 387

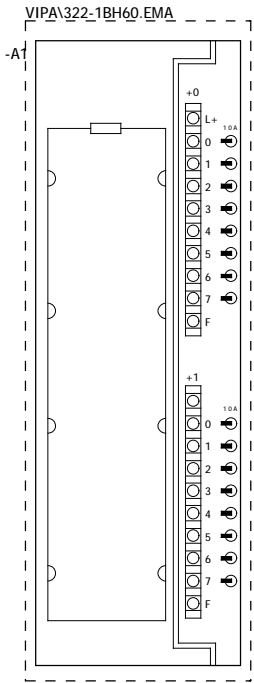

			Datum	30.11.2010	Produktmakros System 300S
			Bearb.	Winkler	
			Gepr		
Anderung	Datum	Name	Urspr		Ersatz von



Frontansicht
322 16xDO DC24V/0,5A
322-1BH60

		=
		+ 322_1BH60
		Blatt 2
		Blatt 387

VIPA\322-1BH60.EMA

A1

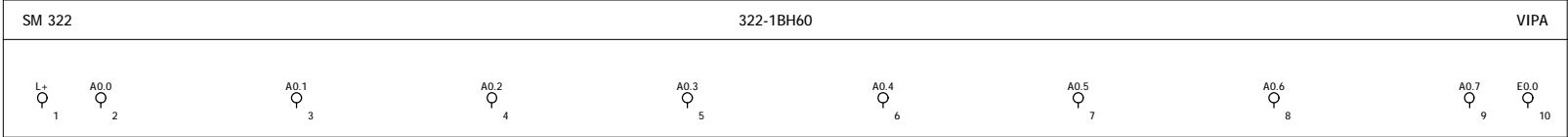

			Datum	08.05.2014	Produktmakros System 300S	YASKAWA	Ausgangsbyte 0 322 16xDO DC24V/0,5A 322-1BH60	=	+ 322_1BH60	Blatt 3
			Bearb.	Winkler						
			Gepr							
Anderung	Datum	Name	Urspr		Ersatz von					Blatt 387

VIPA\322-1BH60.EMA

A1

SM 322

322-1BH60

VIPA

A1.0
12

A1.1
13

A1.2
14

A1.3
15

A1.4
16

A1.5
17

A1.6
18

A1.7
19

M
20

	Datum	08.05.2014	Produktmakros System 300S	
	Bearb.	Winkler		
	Gepr			
Anderung	Datum	Name	Urspr	Ersatz von



Ausgangsbyte 1
322 16xDO DC24V/0,5A
322-1BH60

	=	
	+ 322_1BH60	
	Blatt	4
	Blatt	387

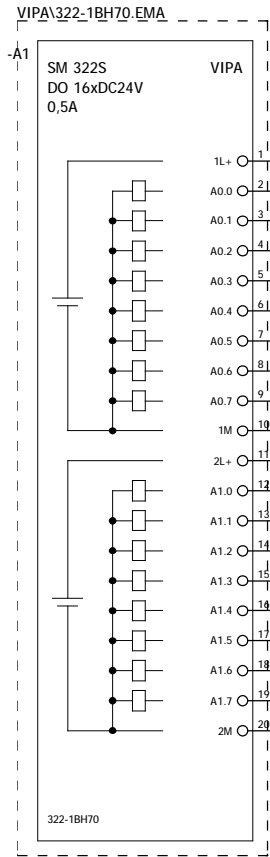

+322_1BH60/4

2

			Datum	08.05.2014	Produktmakros System 300S
			Bearb.	Winkler	
			Gepr		
Anderung	Datum	Name	Urspr		Ersatz von



SPS-Übersicht
SM 322S DO 16xDC 24V 0,5A,
322-1BH70

		=
		+ 322_1BH70
		Blatt 1
		Blatt 387

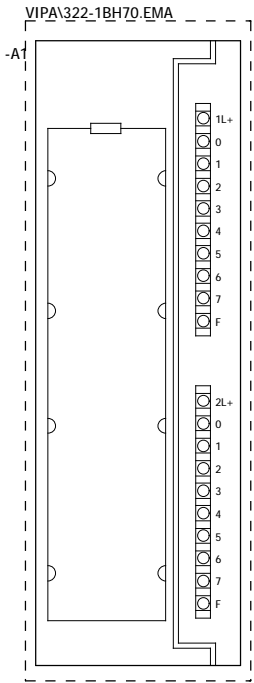

		Datum	30.11.2010	Produktmakros System 300S
		Bearb.	Winkler	
		Gepr		
Anderung	Datum	Name	Urspr	Ersatz von



Frontansicht
SM 322S DO 16xDC 24V 0,5A,
322-1BH70

		=	
		+ 322_1BH70	
			Blatt 2
			Blatt 387

VIPA\322-1BH70.EMA

A1

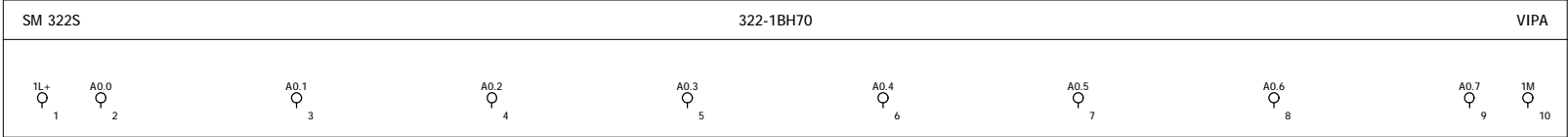

			Datum	08.05.2014	Produktmakros System 300S	YASKAWA	Ausgangsbyte 0 SM 322S DO 16xDC 24V 0,5A, 322-1BH70	=	+ 322_1BH70	Blatt	3
			Bearb.	Winkler							
			Gepr								
Anderung	Datum	Name	Urspr		Ersatz von					Blatt	387

VIPA\322-1BH70.EMA

A1

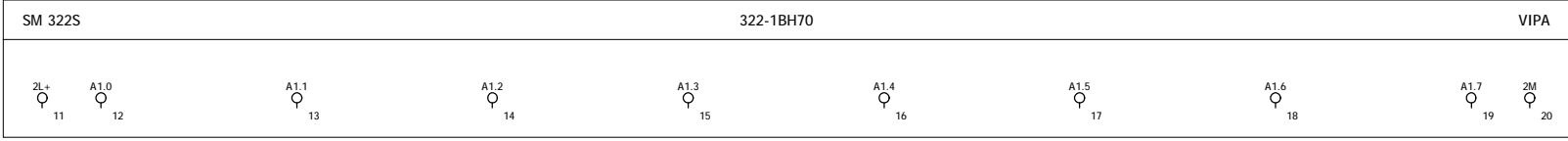

			Datum	08.05.2014	Produktmakros System 300S	YASKAWA	Ausgangsbyte 1 SM 322S DO 16xDC 24V 0,5A, 322-1BH70	=	+ 322_1BH70	Blatt 4
			Bearb.	Winkler						
			Gepr							
Anderung	Datum	Name	Urspr		Ersatz von					Blatt 387

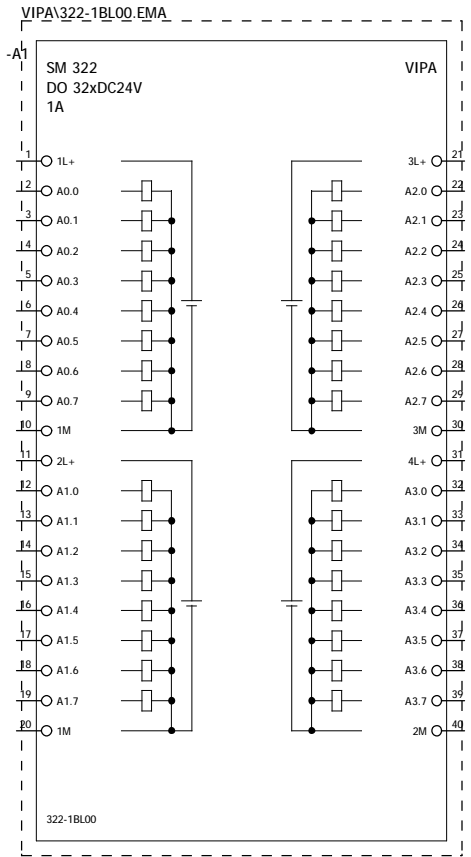

+322_1BH70/4

			Datum	08.05.2014	Produktmakros System 300S
			Bearb.	Winkler	
			Gepr		
Anderung	Datum	Name	Urspr		Ersatz von



SPS-Übersicht
322 32xDC24V/1A
322-1BL00

			=
			+ 322_1BL00
		Blatt	1
		Blatt	387

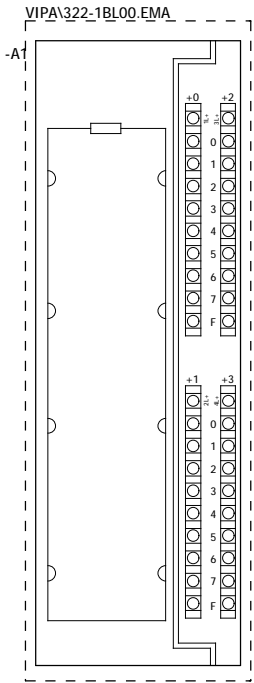

		Datum	30.11.2010	Produktmakros System 300S
		Bearb.	Winkler	
		Gepr		
Anderung	Datum	Name	Urspr	Ersatz von



Frontansicht
322 32xDO DC24V/1A
322-1BL00

		=	
		+ 322_1BL00	
			Blatt 2
			Blatt 387

VIPA\322-1BL00.EMA

A1

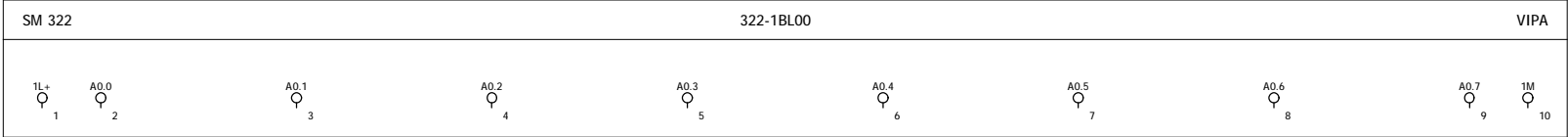

			Datum	08.05.2014	Produktmakros System 300S	YASKAWA	Ausgangsbyte 0 322 32xDO DC24V/1A 322-1BL00	=			
			Bearb.	Winkler				+ 322_1BL00		Blatt	3
			Gepr							Blatt	387
Anderung	Datum	Name	Urspr		Ersatz von						

VIPA\322-1BL00.EMA

A1

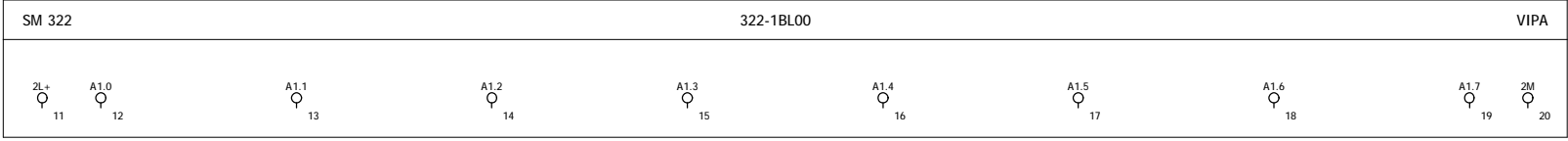

			Datum	08.05.2014	Produktmakros System 300S	YASKAWA	Ausgangsbyte 1 322 32xDO DC24V/1A 322-1BL00	=	+ 322_1BL00	Blatt	4
			Bearb.	Winkler							
			Gepr								
Anderung	Datum	Name	Urspr		Ersatz von					Blatt	387

VIPA\322-1BL00.EMA

A1

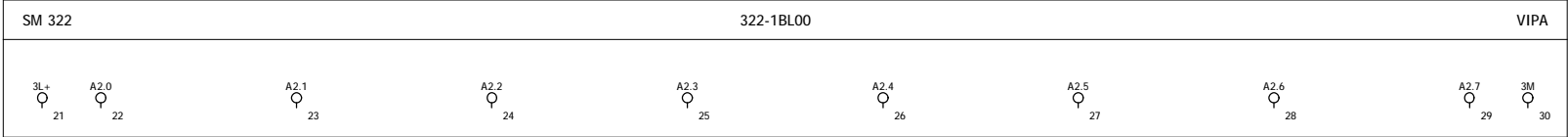

			Datum	08.05.2014	Produktmakros System 300S		Ausgangsbyte 2	=	+ 322_1BL00	Blatt 5
			Bearb.	Winkler			322 32xDO DC24V/1A			
			Gepr				322-1BL00			
Anderung	Datum	Name	Urspr		Ersatz von					Blatt 387

VIPA\322-1BL00.EMA

A1

SM 322

322-1BL00

VIPA

4L+
31

A3.0
32

A3.1
33

A3.2
34

A3.3
35

A3.4
36

A3.5
37

A3.6
38

A3.7
39

4M
40

5

+322_1HH00/1

	Datum	08.05.2014	Produktmakros System 300S	
	Bearb.	Winkler		
	Gepr			
Anderung	Datum	Name	Urspr	Ersatz von



Ausgangsbyte 3
322 32xDO DC24V/1A
322-1BL00

	=	
	+ 322_1BL00	
		Blatt 6
		Blatt 387

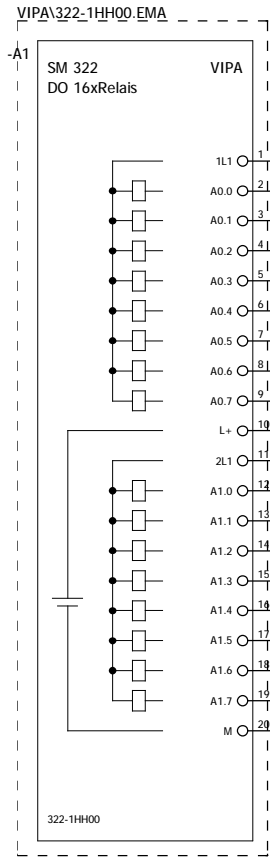

+322_1BL00/6

		Datum	08.05.2014	Produktmakros System 300S
		Bearb.	Winkler	
		Gepr.		
Anderung	Datum	Name	Urspr.	Ersatz von



SPS-Übersicht
322 16xDO RELAIS
322-1HH00

		=
		+ 322_1HH00
	Blatt	1
	Blatt	387

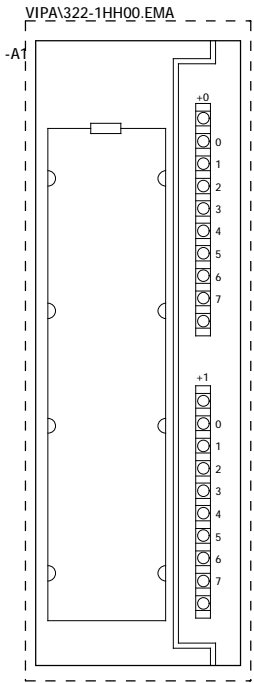

			Datum	30.11.2010	Produktmakros System 300S
			Bearb.	Winkler	
			Gepr		
Anderung	Datum	Name	Urspr		Ersatz von



Frontansicht
322 16xDO RELAIS
322-1HH00

		=
		+ 322_1HH00
		Blatt 2
		Blatt 387

VIPA\322-1HH00.EMA

A1

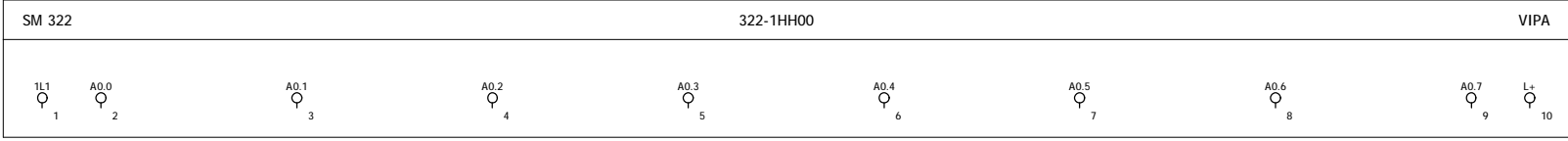

			Datum	08.05.2014	Produktmakros System 300S	YASKAWA	Ausgangsbyte 0 322 16xDO RELAIS 322-1HH00	=	+ 322_1HH00	Blatt	3
			Bearb.	Winkler							
			Gepr								
Anderung	Datum	Name	Urspr		Ersatz von					Blatt	387

VIPA\322-1HH00.EMA

A1

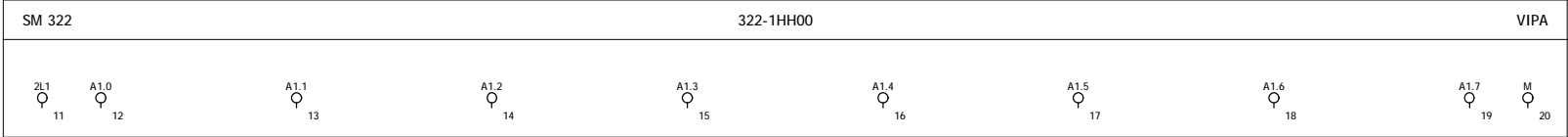

3

+322_5FF00/1

			Datum	08.05.2014	Produktmakros System 300S
			Bearb.	Winkler	
			Gepr		
Anderung	Datum	Name	Urspr		Ersatz von



Ausgangsbyte 1
322 16xDO RELAIS
322-1HH00

		=
		+ 322_1HH00
		Blatt 4
		Blatt 387

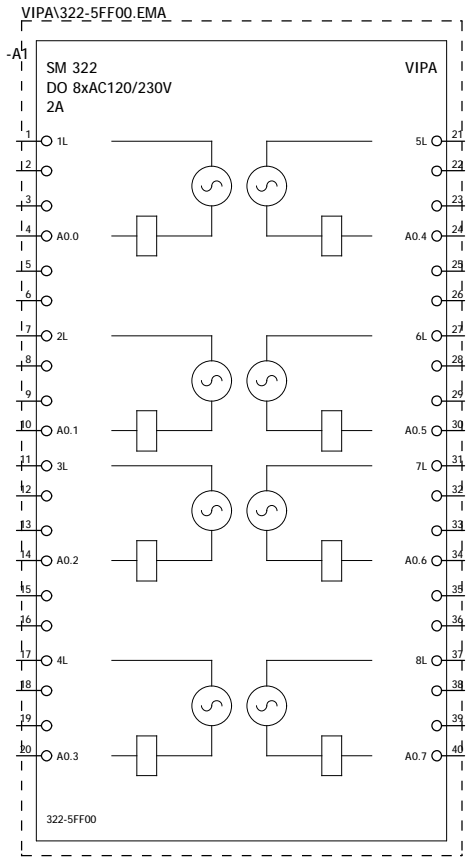

+322_1HH00/4

2

			Datum	08.05.2014	Produktmakros System 300S
			Bearb.	Winkler	
			Gepr		
Anderung	Datum	Name	Urspr		Ersatz von



SPS-Übersicht
322 8xDO AC120/230V/2A
322-5FF00

		=
		+ 322_5FF00
	Blatt	1
	Blatt	387

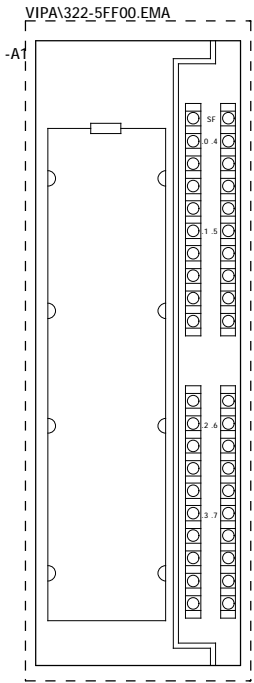

		Datum	30.11.2010	Produktmakros System 300S
		Bearb.	Winkler	
		Gepr.		
Anderung	Datum	Name	Urspr.	Ersatz von



Frontansicht
 322 8xDO AC120/230V/2A
 322-5FF00

		=	
		+ 322_5FF00	
			Blatt 2
			Blatt 387

VIPA\322-5FF00.EMA

A1

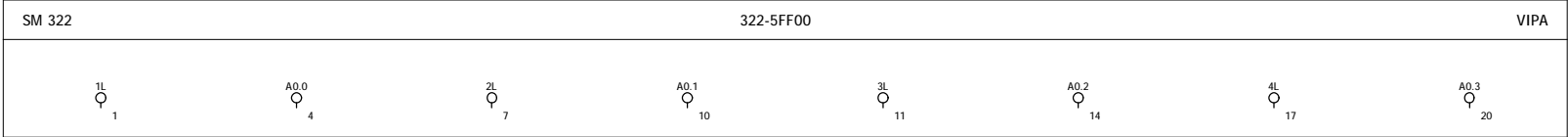

			Datum	08.05.2014	Produktmakros System 300S		Ausgangsbyte 0	=	+ 322_5FF00	Blatt 3
			Bearb.	Winkler			322 8xDO AC120/230V/2A			
			Gepr				322-5FF00			
Anderung	Datum	Name	Urspr		Ersatz von					Blatt 387

VIPA\322-5FF00.EMA

A1

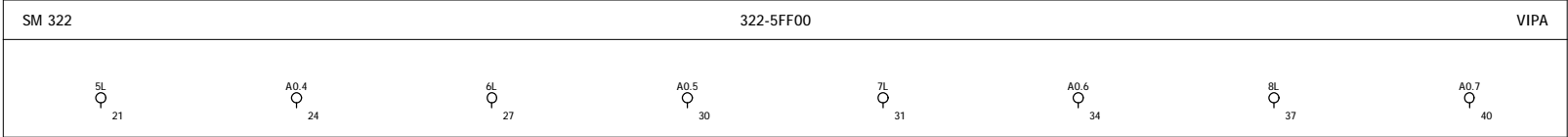

3

+323_1BH00/1

			Datum	08.05.2014	Produktmakros System 300S	YASKAWA	Ausgangsbyte 0 322 8xDO AC120/230V/2A 322-5FF00	=	+ 322_5FF00	Blatt 4
			Bearb.	Winkler						
			Gepr							
Anderung	Datum	Name	Urspr		Ersatz von					Blatt 387

VIPA 323-1BH00.EMA

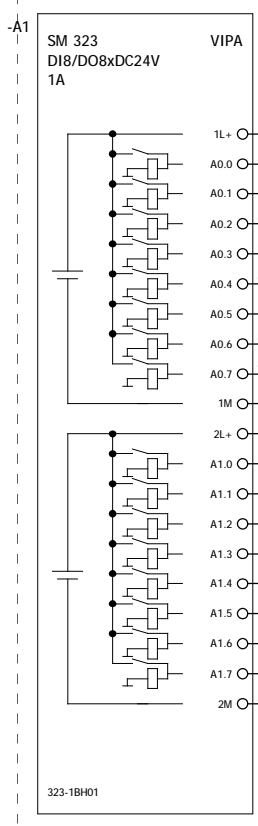

VIPA 323-1BH00.EMA

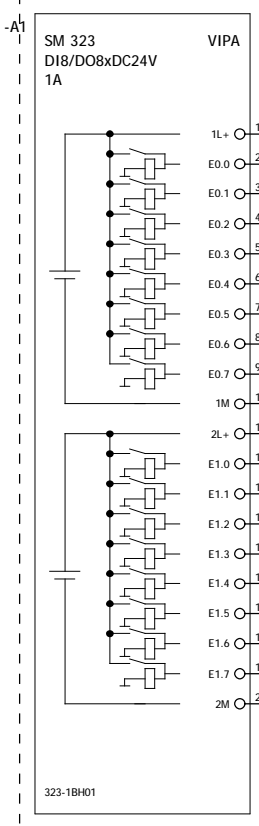

+322_5FF00/4

			Datum	08.05.2014	Produktmakros System 300S
			Bearb.	Winkler	
			Gepr		
Anderung	Datum	Name	Urspr		Ersatz von



SPS-Übersicht
323 16xDIO DC24V/1A
323-1BH00

		=	
		+ 323_1BH00	
		Blatt	1
		Blatt	387

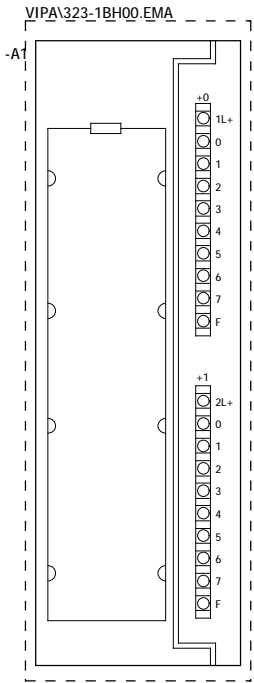

			Datum	30.11.2010	Produktmakros System 300S
			Bearb.	Winkler	
			Gepr		
Anderung	Datum	Name	Urspr		Ersatz von



Frontansicht
323 16xDIO DC24V/1A
323-1BH00

		=
		+ 323_1BH00
		Blatt 2
		Blatt 387

VIPA\323-1BH00.EMA

A1

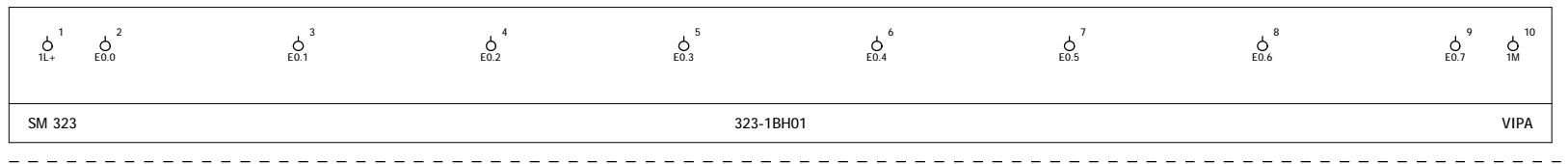

			Datum	08.05.2014	Produktmakros System 300S	YASKAWA	Eingangsbyte 0 323 16xDIO DC24V/1A 323-1BH00	=	+ 323_1BH00	Blatt	3
			Bearb.	Winkler							
			Gepr								
Anderung	Datum	Name	Urspr		Ersatz von					Blatt	387

VIPA\323-1BH00.EMA

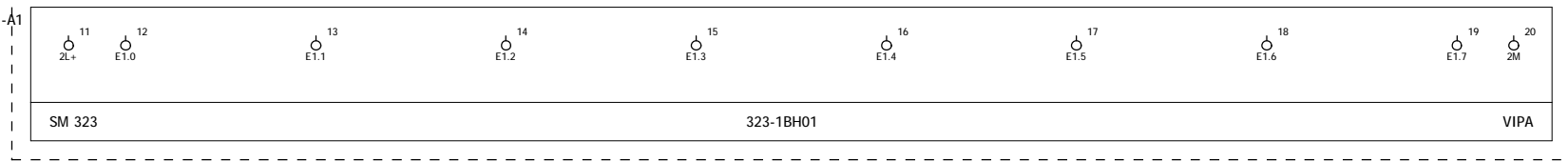

			Datum	08.05.2014	Produktmakros System 300S	YASKAWA	Eingangsbyte 1 323 16xDIO DC24V/1A 323-1BH00	=	+ 323_1BH00	Blatt	4
			Bearb.	Winkler							
			Gepr								
Anderung	Datum	Name	Urspr		Ersatz von					Blatt	387

VIPA\323-1BH00.EMA

A1

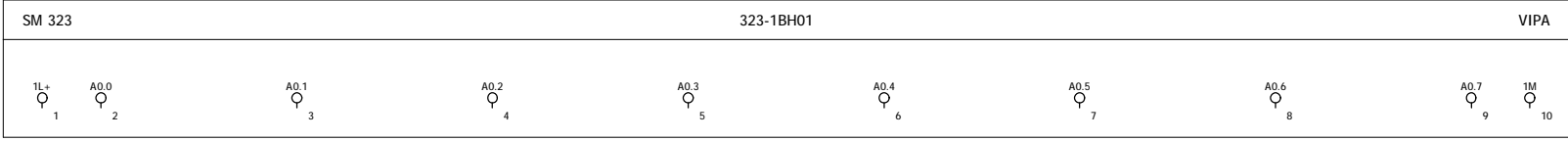

			Datum	08.05.2014	Produktmakros System 300S	YASKAWA	Ausgangsbyte 0 323 16xDIO DC24V/1A 323-1BH00	=	+ 323_1BH00	Blatt	5
			Bearb.	Winkler							
			Gepr								
Anderung	Datum	Name	Urspr		Ersatz von					Blatt	387

VIPA\323-1BH00.EMA

A1

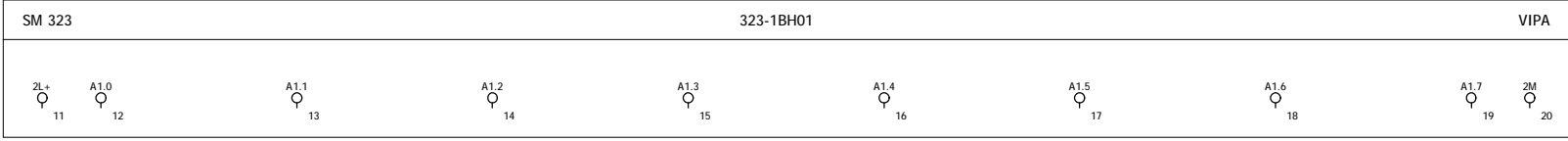

	Datum	08.05.2014	Produktmakros System 300S	
	Bearb.	Winkler		
	Gepr			
Anderung	Datum	Name	Urspr	Ersatz von



Ausgangsbyte 1
323 16xDIO DC24V/1A
323-1BH00

=	
+ 323_1BH00	
Blatt	6
Blatt	387

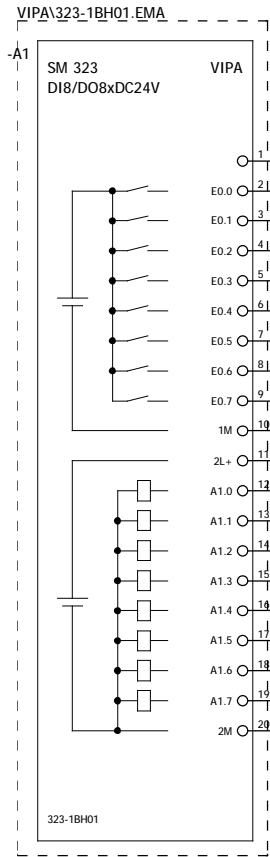

+323_1BH00/6

2

			Datum	08.05.2014	Produktmakros System 300S
			Bearb.	Winkler	
			Gepr		
Anderung	Datum	Name	Urspr		Ersatz von



SPS-Übersicht
SM 323 8xDI, 8xDO DC24V
323-1BH01

		=
		+ 323_1BH01
		Blatt 1
		Blatt 387

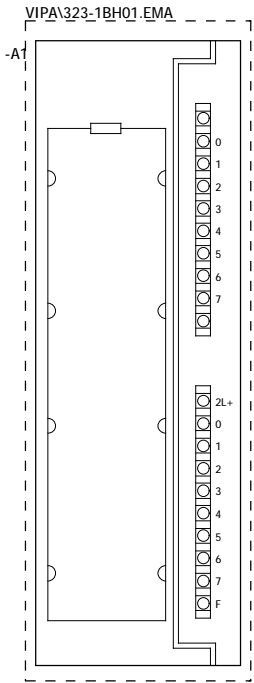

		Datum	30.11.2010	Produktmakros System 300S
		Bearb.	Winkler	
		Gepr		
Anderung	Datum	Name	Urspr	Ersatz von



Frontansicht
SM 323 8xDI, 8xDO DC24V
323-1BH01

		=	
		+ 323_1BH01	
			Blatt 2
			Blatt 387

VIPA\323-1BH01.EMA

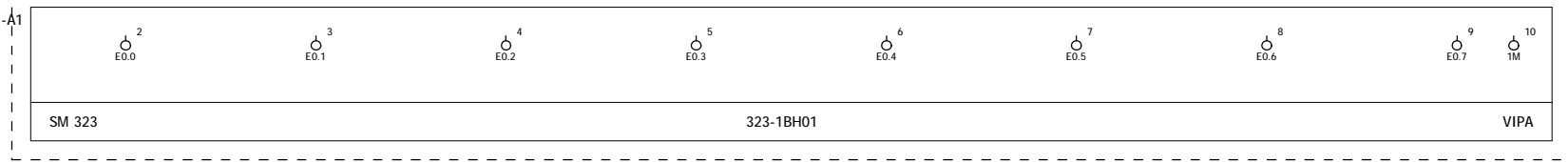

			Datum	08.05.2014	Produktmakros System 300S	YASKAWA	Eingangsbyte 0 SM 323 8xDI, 8xDO DC24V 323-1BH01	=	+ 323_1BH01	Blatt	3
			Bearb.	Winkler							
			Gepr								
Anderung	Datum	Name	Urspr		Ersatz von					Blatt	387

VIPA\323-1BH01.EMA

A1

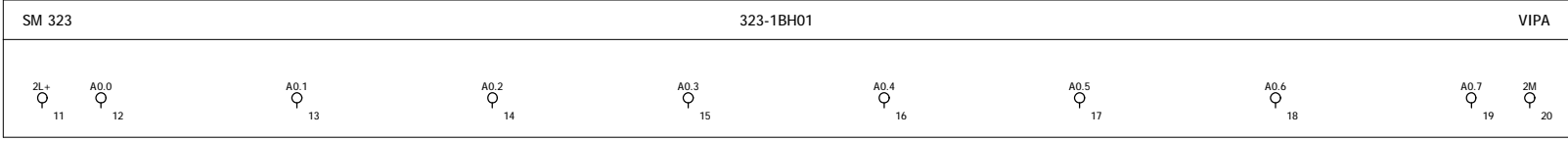

3

+323_1BH70/1

	Datum	08.05.2014	Produktmakros System 300S	
	Bearb.	Winkler		
	Gepr			
Anderung	Datum	Name	Urspr	Ersatz von



Ausgangsbyte 0
SM 323 8xDI, 8xDO DC24V
323-1BH01

	=	
	+ 323_1BH01	
	Blatt	4
	Blatt	387

VIPA323-1BH70.EMA

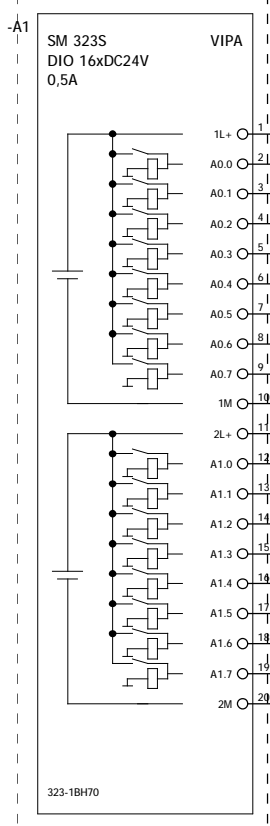

VIPA323-1BH70.EMA

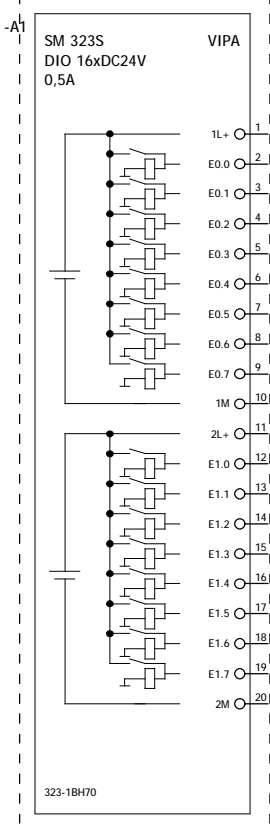

+323_1BH01/4

			Datum	08.05.2014	Produktmakros System 300S
			Bearb.	Winkler	
			Gepr		
Anderung	Datum	Name	Urspr		Ersatz von



SPS-Übersicht
SM 323S DIO 16xDC 24V 0,5A,
323-1BH70

		=
		+ 323_1BH70
		Blatt 1
		Blatt 387

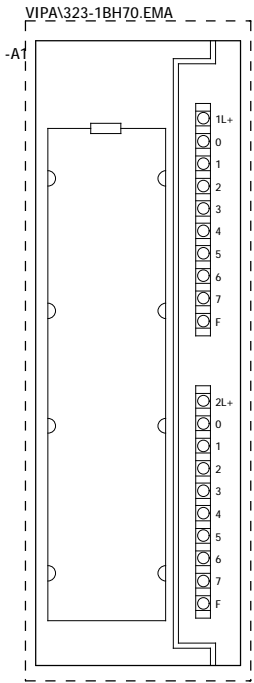

		Datum	30.11.2010	Produktmakros System 300S
		Bearb.	Winkler	
		Gepr		
Anderung	Datum	Name	Urspr	Ersatz von



Frontansicht
SM 323S DIO 16xDC 24V 0,5A,
323-1BH70

		=	
		+ 323_1BH70	
			Blatt 2
			Blatt 387

VIPA\323-1BH70.EMA

A1

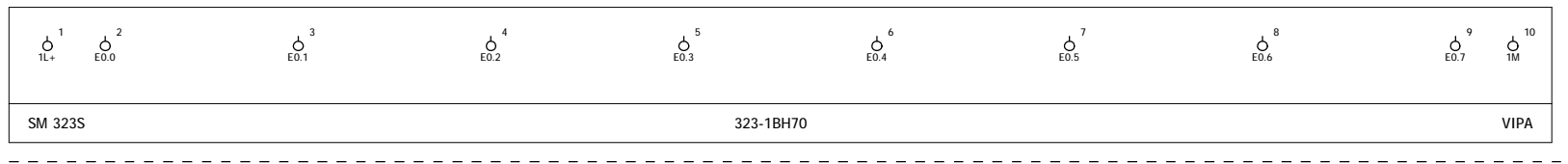

VIPA\323-1BH70.EMA

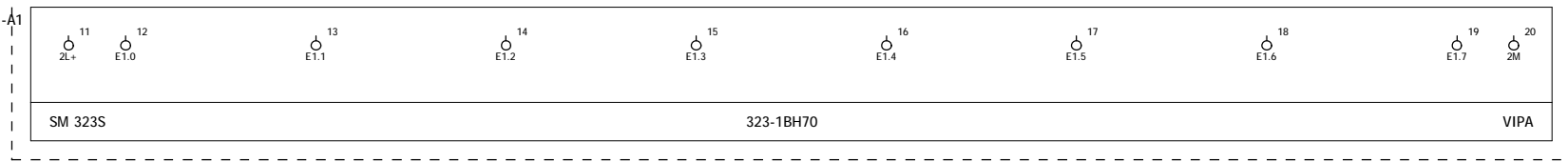

3

5

			Datum	08.05.2014	Produktmakros System 300S	YASKAWA	Eingangsbyte 1 SM 323S DIO 16xDC 24V 0,5A, 323-1BH70	=	+ 323_1BH70	Blatt	4
			Bearb.	Winkler							
			Gepr								
Anderung	Datum	Name	Urspr		Ersatz von					Blatt	387

VIPA\323-1BH70.EMA

A1

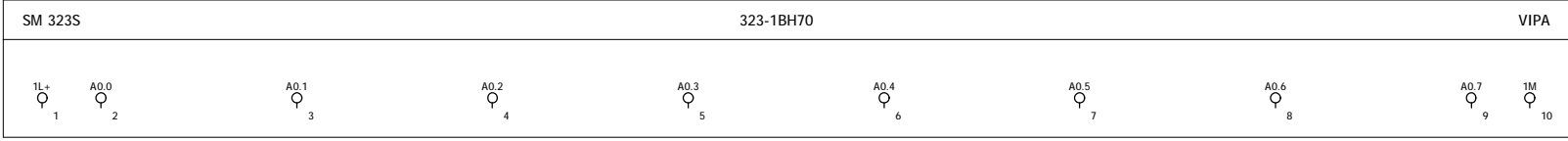

			Datum	08.05.2014	Produktmakros System 300S	YASKAWA	Ausgangsbyte 0 SM 323S DIO 16xDC 24V 0,5A, 323-1BH70	=	+ 323_1BH70	Blatt 5
			Bearb.	Winkler						
			Gepr							
Anderung	Datum	Name	Urspr		Ersatz von					Blatt 387

VIPA\323-1BH70.EMA

A1

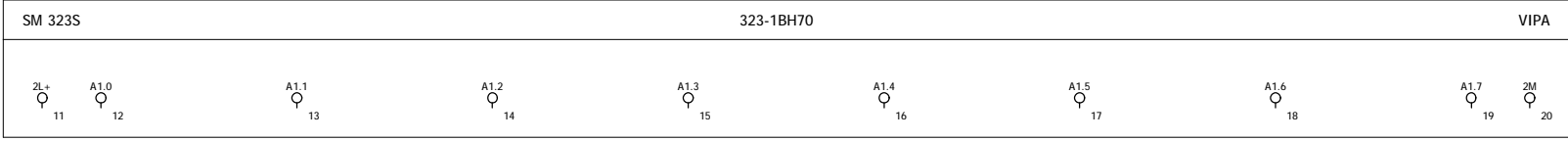

			Datum	08.05.2014	Produktmakros System 300S	YASKAWA	Ausgangsbyte 1 SM 323S DIO 16xDC 24V 0,5A, 323-1BH70	=	+ 323_1BH70	Blatt	6
			Bearb.	Winkler						Blatt	387
			Gepr								
Anderung	Datum	Name	Urspr		Ersatz von						

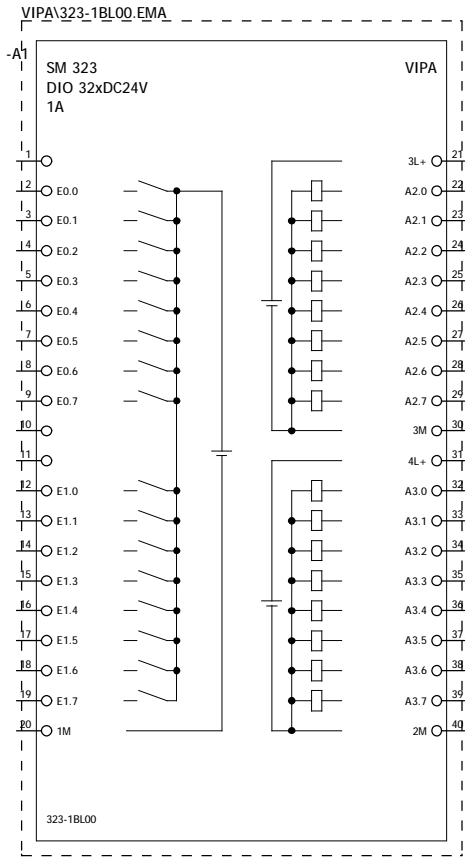

+323_1BH70/6

			Datum	08.05.2014	Produktmakros System 300S
			Bearb.	Winkler	
			Gepr		
Anderung	Datum	Name	Urspr		Ersatz von



SPS-Übersicht
SM 323 16xDI, 16xDO DC24V
323-1BL00

		=
		+ 323_1BL00
		Blatt 1
		Blatt 387

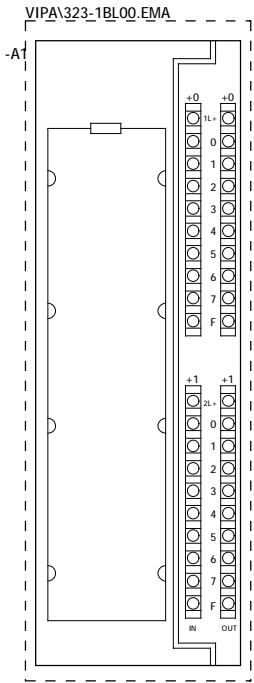

			Datum	30.11.2010	Produktmakros System 300S
			Bearb.	Winkler	
			Gepr		
Anderung	Datum	Name	Urspr		Ersatz von



Frontansicht
SM 323 16xDI, 16xDO DC24V
323-1BL00

		=
		+ 323_1BL00
		Blatt 2
		Blatt 387

VIPA\323-1BHLO.EMA

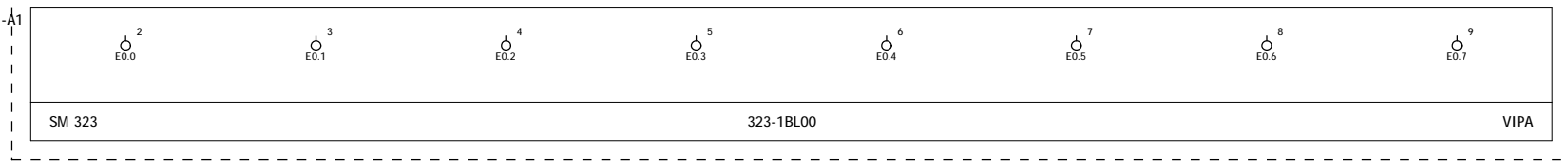

			Datum	08.05.2014	Produktmakros System 300S	YASKAWA	Eingangsbyte 0 SM 323 16xDI, 16xDO DC24V 323-1BL00	=	+ 323_1BL00	Blatt	3
			Bearb.	Winkler							
			Gepr								
Anderung	Datum	Name	Urspr		Ersatz von					Blatt	387

VIPA\323-1BL00.EMA

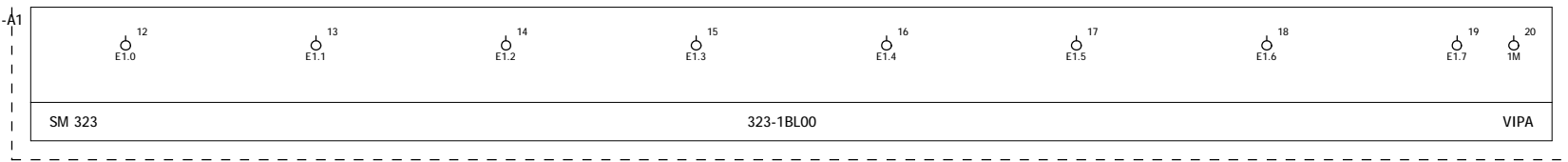

			Datum	08.05.2014	Produktmakros System 300S	YASKAWA	Eingangsbyte 1 SM 323 16xDI, 16xDO DC24V 323-1BL00		=	+ 323_1BL00	Blatt	4
			Bearb.	Winkler								
			Gepr									
Anderung	Datum	Name	Urspr		Ersatz von						Blatt	387

VIPA\323-1BL00.EMA

A1

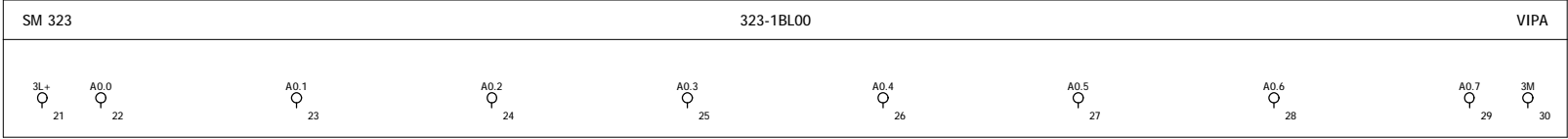

			Datum	08.05.2014	Produktmakros System 300S	YASKAWA	Ausgangsbyte 0 SM 323 16xDI, 16xDO DC24V 323-1BL00	=	+ 323_1BL00	Blatt 5
			Bearb.	Winkler						
			Gepr							
Anderung	Datum	Name	Urspr		Ersatz von					Blatt 387

VIPA\323-1BL00.EMA

A1

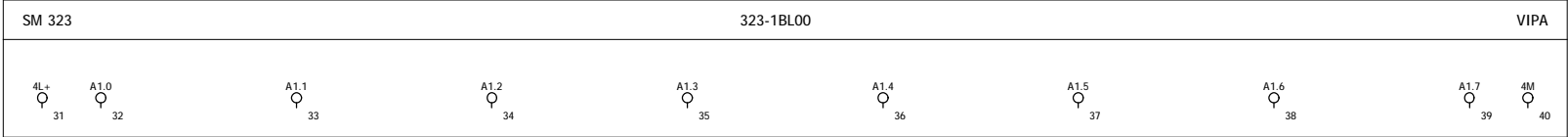

			Datum	08.05.2014	Produktmakros System 300S	YASKAWA	Ausgangsbyte 1 SM 323 16xDI, 16xDO DC24V 323-1BL00	=	+ 323_1BL00	Blatt	6
			Bearb.	Winkler						Blatt	387
			Gepr								
Anderung	Datum	Name	Urspr		Ersatz von						

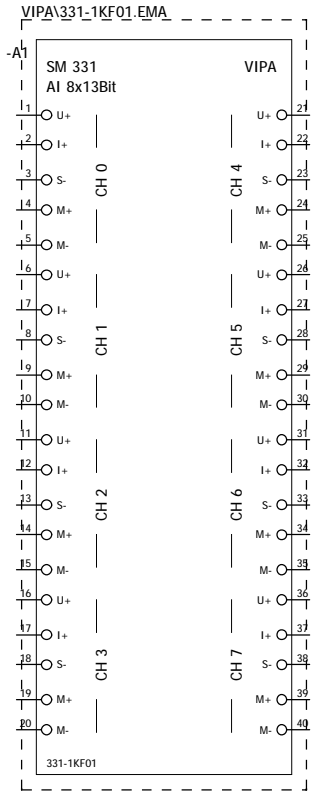

+323_1BL00/6

2

			Datum	08.05.2014	Produktmakros System 300S
			Bearb.	Winkler	
			Gepr.		
Anderung	Datum	Name	Urspr		Ersatz von



SPS-Übersicht
SM 331 AI 8x13 Bit
331-1KF01

		=
		+ 331_1KF01
		Blatt 1
		Blatt 387

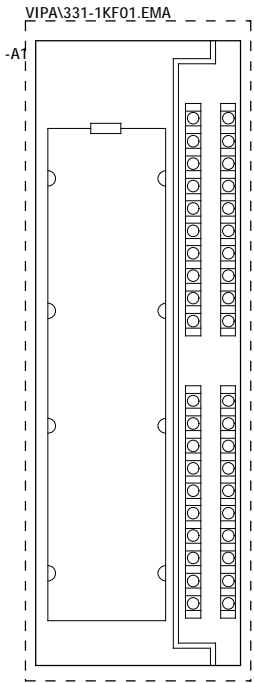

		Datum	30.11.2010	Produktmakros System 300S
		Bearb.	Winkler	
		Gepr.		
Anderung	Datum	Name	Urspr.	Ersatz von



Frontansicht
SM 331 AI 8x13 Bit
331-1KF01

		=	
		+ 331_1KF01	
		Blatt	2
		Blatt	387

VIPA\331-1KF01.EMA

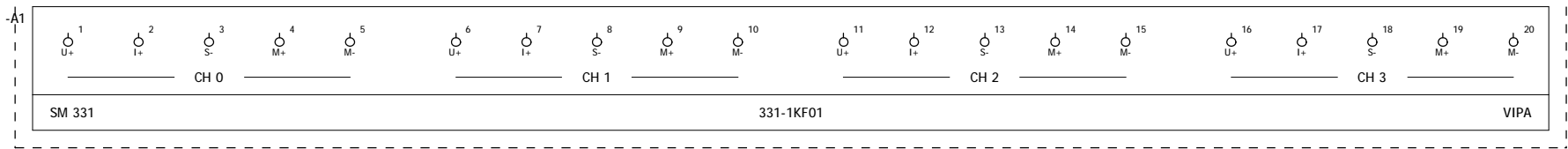

SM 331

331-1KF01

VIPA

			Datum	08.05.2014	Produktmakros System 300S	YASKAWA	Eingangskanal 0-3 SM 331 AI 8x13 Bit 331-1KF01		=	+ 331_1KF01	Blatt	3
			Bearb.	Winkler								
			Gepr									
Anderung	Datum	Name	Urspr		Ersatz von						Blatt	387

VIPA\331-1KF01.EMA

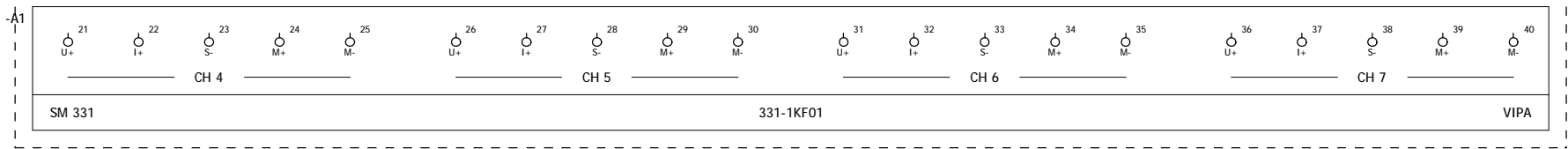

3

+331_7AF70/1

			Datum	08.05.2014	Produktmakros System 300S	YASKAWA	Eingangskanal 4-7 SM 331 AI 8x13 Bit 331-1KF01		=	+ 331_1KF01	Blatt	4
			Bearb.	Winkler								
			Gepr									
Anderung	Datum	Name	Urspr		Ersatz von						Blatt	387

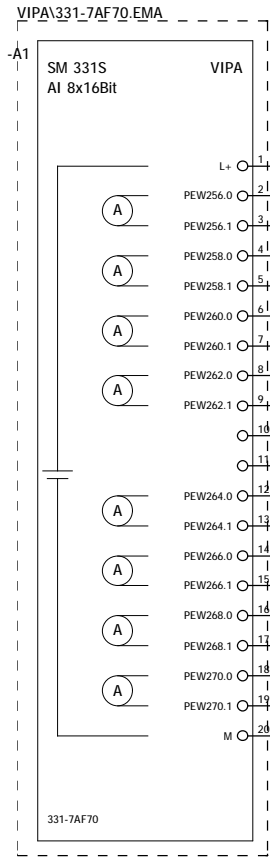

+331_1KF01/4

			Datum	08.05.2014	Produktmakros System 300S
			Bearb.	Winkler	
			Gepr.		
Anderung	Datum	Name	Urspr.		Ersatz von



SPS-Übersicht
SM 331 AI 8x16 Bit
331-7AF70

=
+ 331_7AF70

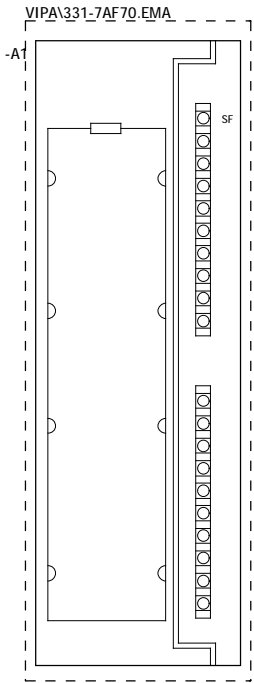

		Datum	30.11.2010	Produktmakros System 300S
		Bearb.	Winkler	
		Gepr.		
Anderung	Datum	Name	Urspr.	Ersatz von



Frontansicht
SM 331 AI 8x16 Bit
331-7AF70

		=	
		+ 331_7AF70	
		Blatt	2
		Blatt	387

VIPA\331-7AF70.EMA

A1

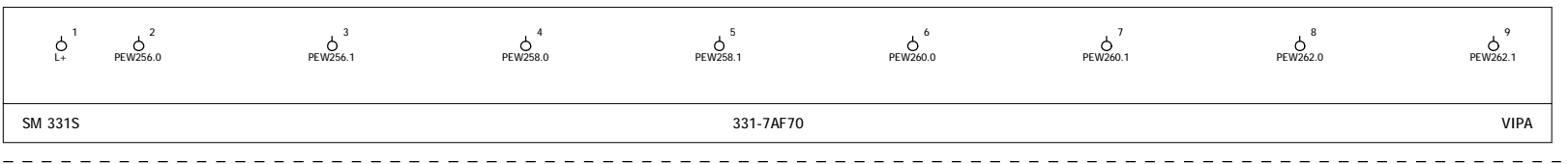

			Datum	08.05.2014	Produktmakros System 300S	YASKAWA	Eingangskanal 0-3 SM 331 AI 8x16 Bit 331-7AF70		=	+ 331_7AF70	Blatt	3
			Bearb.	Winkler								
			Gepr									
Anderung	Datum	Name	Urspr		Ersatz von						Blatt	387

VIPA\331-7AF70.EMA

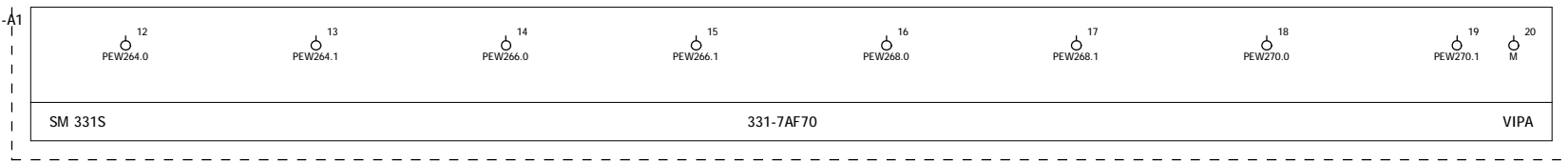

3

+331_7BF70/1

			Datum	08.05.2014	Produktmakros System 300S	YASKAWA	Eingangskanal 4-7 SM 331 AI 8x16 Bit 331-7AF70		=	+ 331_7AF70	Blatt 4
			Bearb.	Winkler							
			Gepr								
Anderung	Datum	Name	Urspr		Ersatz von						Blatt 387

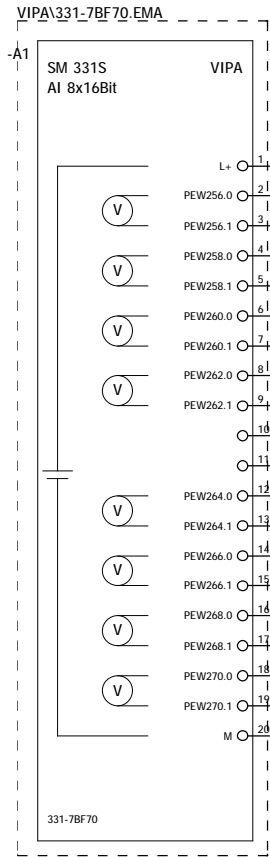

+331_7AF70/4

			Datum	08.05.2014	Produktmakros System 300S
			Bearb.	Winkler	
			Gepr		
Anderung	Datum	Name	Urspr		Ersatz von



SPS-Übersicht
SM 331 AI 8x16 Bit
331-7BF70

=
+ 331_7BF70

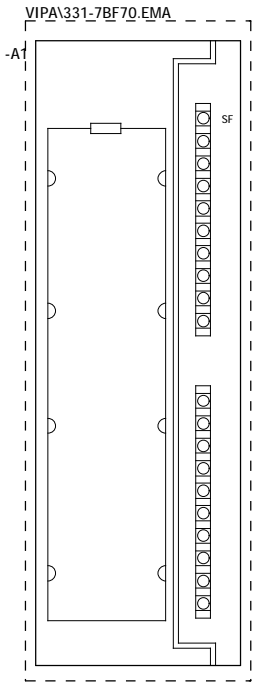

		Datum	30.11.2010	Produktmakros System 300S
		Bearb.	Winkler	
		Gepr.		
Anderung	Datum	Name	Urspr.	Ersatz von



Frontansicht
SM 331 AI 8x16 Bit
331-7BF70

		=	
		+ 331_7BF70	
			Blatt 2
			Blatt 387

VIPA\331-7BF70.EMA

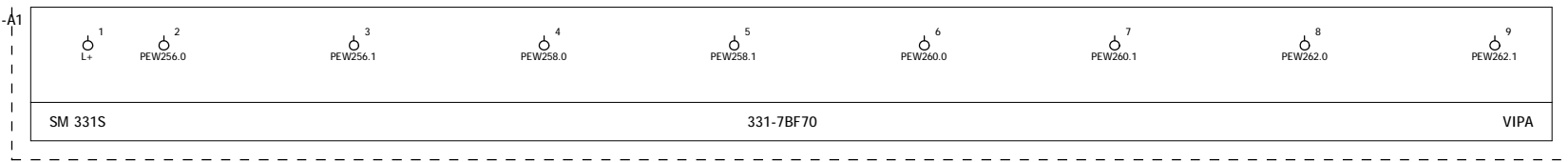

			Datum	08.05.2014	Produktmakros System 300S	YASKAWA	Eingangskanal 0-3 SM 331 AI 8x16 Bit 331-7BF70		=	+ 331_7BF70	Blatt	3
			Bearb.	Winkler							Blatt	387
Anderung	Datum	Name	Urspr	Ersatz von								

VIPA\331-7BF70.EMA

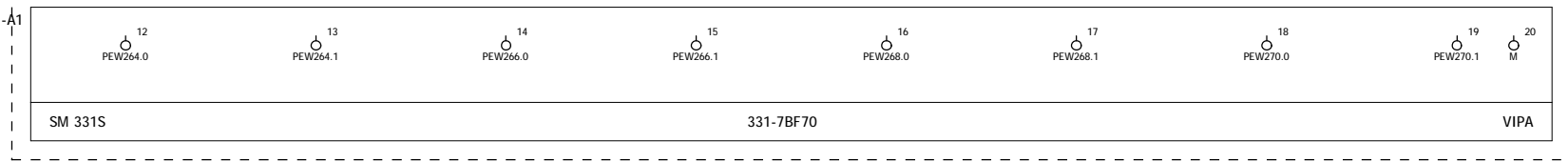

3

+331_7KB01/1

			Datum	08.05.2014	Produktmakros System 300S	YASKAWA	Eingangskanal 4-7 SM 331 AI 8x16 Bit 331-7BF70		=	+ 331_7BF70	Blatt 4
			Bearb.	Winkler							
			Gepr								
Anderung	Datum	Name	Urspr		Ersatz von						Blatt 387

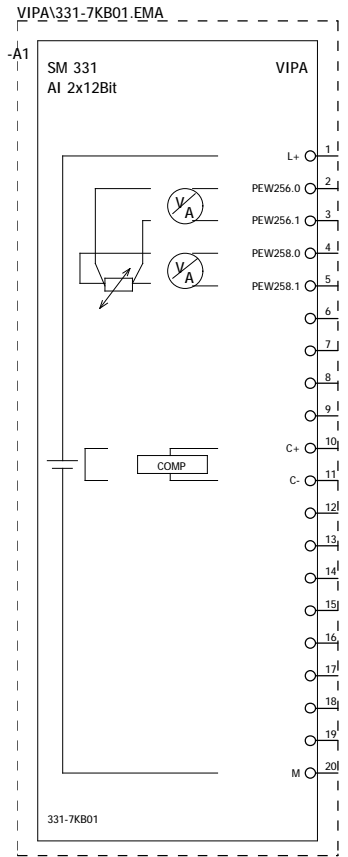

+331_7BF70/4

2

			Datum	08.05.2014	Produktmakros System 300S
			Bearb.	Winkler	
			Gepr		
Anderung	Datum	Name	Urspr		Ersatz von



SPS-Übersicht
SM 331 AI 2x12 Bit
331-7KB01

=	
+ 331_7KB01	
Blatt	1
Blatt	387

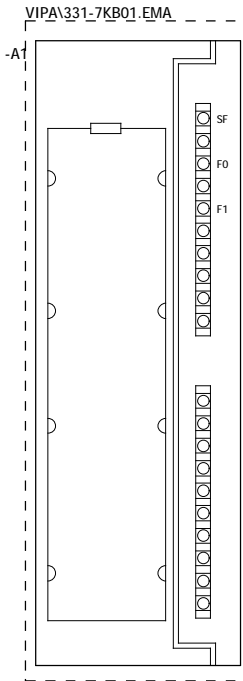

			Datum	30.11.2010	Produktmakros System 300S
			Bearb.	Winkler	
			Gepr		
Anderung	Datum	Name	Urspr		Ersatz von



Frontansicht
SM 331 AI 2x12 Bit
331-7KB01

		=
		+ 331_7KB01
		Blatt 2
		Blatt 387

VIPA\331-7KB01.EMA

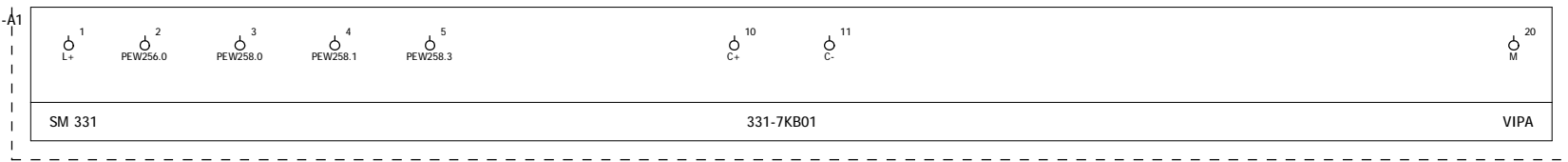

			Datum	08.05.2014	Produktmakros System 300S
			Bearb.	Winkler	
			Gepr		
Anderung	Datum	Name	Urspr		Ersatz von



Eingangskanal 0/1
SM 331 AI 2x12 Bit
331-7KB01

		=
		+ 331_7KB01
	Blatt	3
	Blatt	387

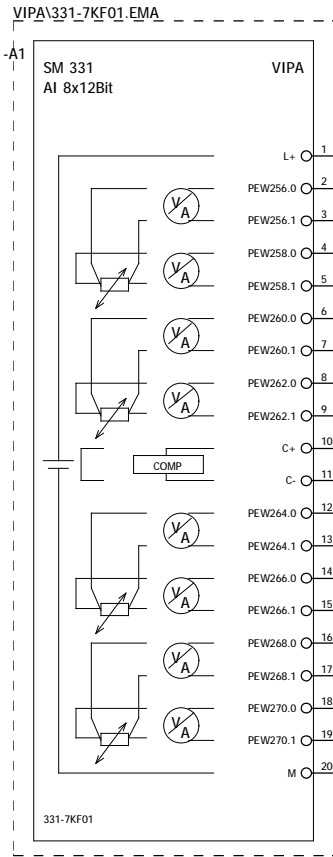

+331_7KB01/3

2

			Datum	08.05.2014	Produktmakros System 300S
			Bearb.	Winkler	
			Gepr.		
Anderung	Datum	Name	Urspr		Ersatz von



SPS-Übersicht
SM 331 AI 8x12 Bit
331-7KF01

		=
		+ 331_7KF01
		Blatt 1
		Blatt 387

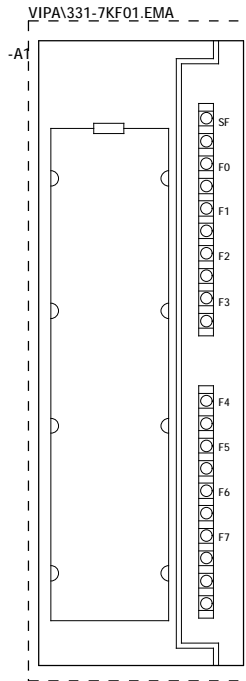

			Datum	30.11.2010	Produktmakros System 300S
			Bearb.	Winkler	
			Gepr		
Anderung	Datum	Name	Urspr		Ersatz von



Frontansicht
SM 331 AI 8x12 Bit
331-7KF01

		=
		+ 331_7KF01
		Blatt 2
		Blatt 387

VIPA\331-7KF01.EMA

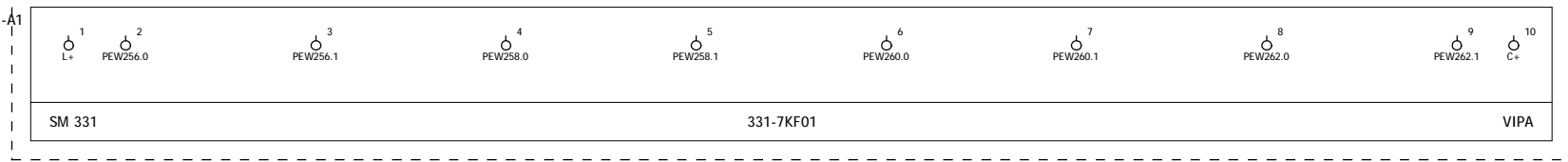

			Datum	08.05.2014	Produktmakros System 300S	YASKAWA	Eingangskanal 0-3 SM 331 AI 8x12Bit 331-7KF01		=	+ 331_7KF01	Blatt	3
			Bearb.	Winkler								
			Gepr									
Anderung	Datum	Name	Urspr		Ersatz von						Blatt	387

VIPA\331-7KF01.EMA

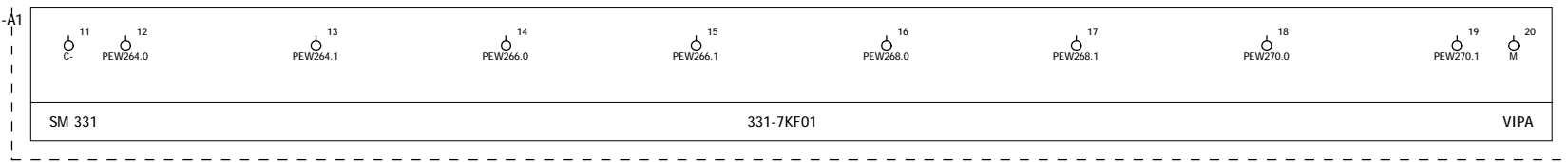

3

+332_5HB01/1

			Datum	08.05.2014	Produktmakros System 300S	YASKAWA	Eingangskanal 4-7 SM 331 AI 8x12Bit 331-7KF01		=	+ 331_7KF01	Blatt 4
			Bearb.	Winkler							
			Gepr								
Anderung	Datum	Name	Urspr		Ersatz von						Blatt 387

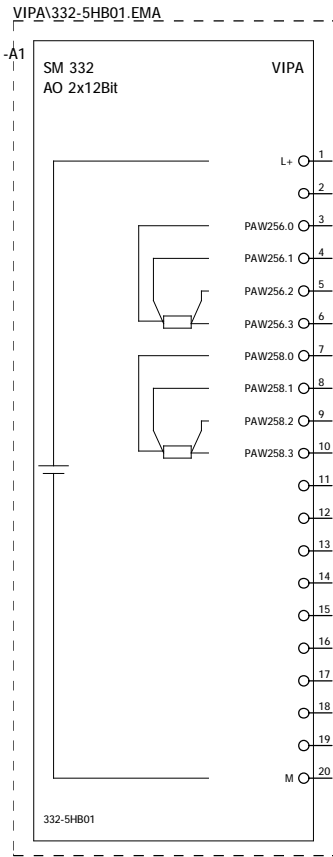

+331_7KF01/4

			Datum	08.05.2014	Produktmakros System 300S
			Bearb.	Winkler	
			Gepr		
Anderung	Datum	Name	Urspr		Ersatz von



SPS-Übersicht
SM 332 AO 2x12 Bit
332-5HB01

		=
		+ 332_5HB01
		Blatt 1
		Blatt 387

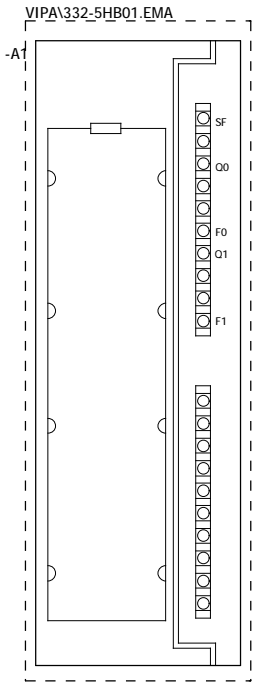

			Datum	30.11.2010	Produktmakros System 300S
			Bearb.	Winkler	
			Gepr		
Anderung	Datum	Name	Urspr		Ersatz von



Frontansicht
SM 332 AO 2x12 Bit
332-5HB01

		=
		+ 332_5HB01
		Blatt 2
		Blatt 387

VIPA\332-5HB01.EMA

A1

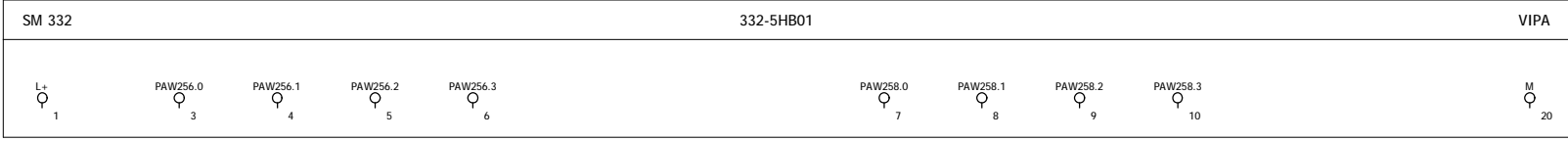

			Datum	08.05.2014	Produktmakros System 300S
			Bearb.	Winkler	
			Gepr		
Anderung	Datum	Name	Urspr		Ersatz von



Ausgangskanal 0/1
SM 332 AO 2x12 Bit
332-5HB01

		=
		+ 332_5HB01
	Blatt	3
	Blatt	387

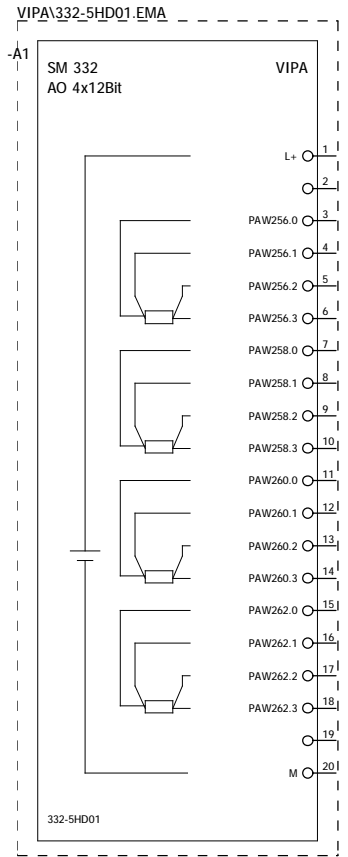

+332_5HB01/3

			Datum	08.05.2014	Produktmakros System 300S
			Bearb.	Winkler	
			Gepr		
Anderung	Datum	Name	Urspr		Ersatz von



SPS-Übersicht
SM 332 AO 4x12Bit
332-5HD01

		=
		+ 332_5HD01
		Blatt 1
		Blatt 387

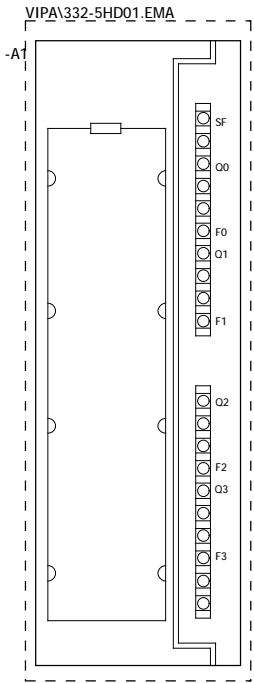

		Datum	30.11.2010	Produktmakros System 300S
		Bearb.	Winkler	
		Gepr.		
Anderung	Datum	Name	Urspr.	Ersatz von



Frontansicht
SM 332 AO 4x12Bit
332-5HD01

		=
		+ 332_5HD01
		Blatt 2
		Blatt 387

VIPA\332-5HD01.EMA

A1

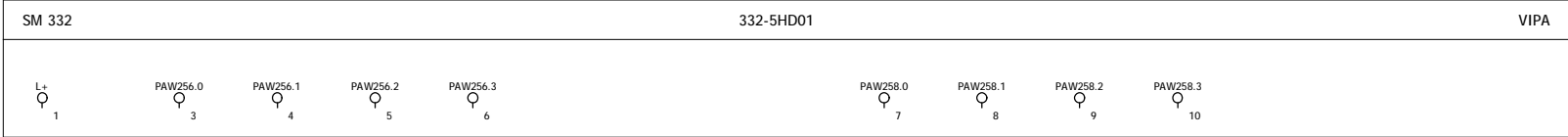

			Datum	08.05.2014	Produktmakros System 300S	YASKAWA	Ausgangskanal 0/1 SM 332 AO 4x12Bit 332-5HD01	=	+ 332_5HD01	Blatt 3
			Bearb.	Winkler						
			Gepr							
Anderung	Datum	Name	Urspr		Ersatz von					Blatt 387

VIPA\332-5HD01.EMA

A1

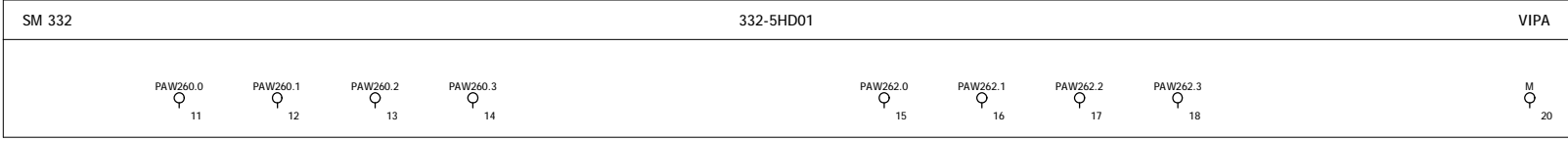

3

+332_5HD50/1

	Datum	08.05.2014	Produktmakros System 300S	
	Bearb.	Winkler		
	Gepr			
Anderung	Datum	Name	Urspr	Ersatz von



Ausgangskanal 2/3
SM 332 AO 4x12Bit
332-5HD01

		=
		+ 332_5HD01
	Blatt	4
	Blatt	387

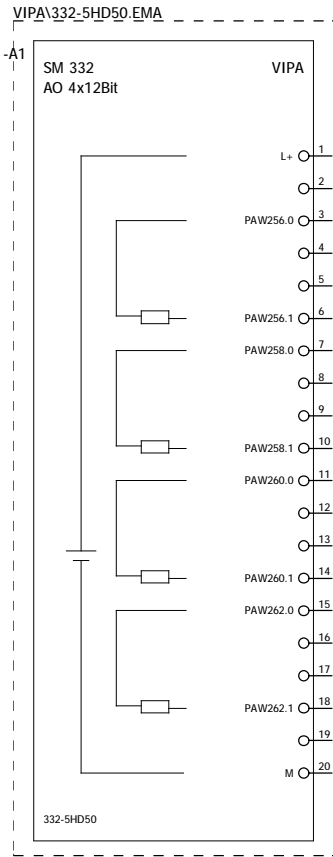

+332_5HD01/4

			Datum	08.05.2014	Produktmakros System 300S
			Bearb.	Winkler	
			Gepr		
Anderung	Datum	Name	Urspr		Ersatz von



SPS-Übersicht
SM 332 AO 4x12Bit I
332-5HD50

		=
		+ 332_5HD50
		Blatt 1
		Blatt 387

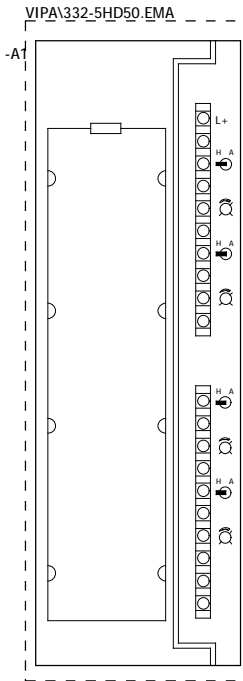

			Datum	30.11.2010	Produktmakros System 300S
			Bearb.	Winkler	
			Gepr		
Anderung	Datum	Name	Urspr		Ersatz von



Frontansicht
SM 332 AO 4x12Bit I
332-5HD50

		=
		+ 332_5HD50
		Blatt 2
		Blatt 387

VIPA\332-5HD50.EMA

A1

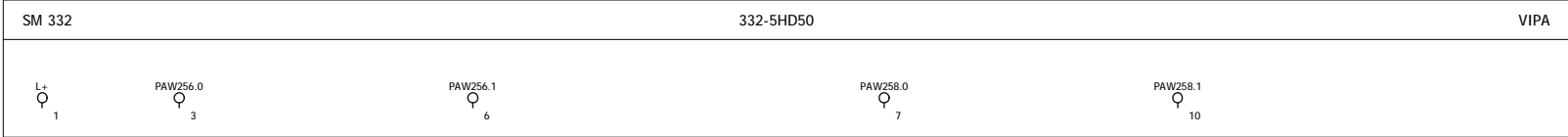

			Datum	08.05.2014	Produktmakros System 300S	YASKAWA	Ausgangskanal 0/1 SM 332 AO 4x12Bit I 332-5HD50	=	+ 332_5HD50	Blatt	3
			Bearb.	Winkler							
			Gepr								
Anderung	Datum	Name	Urspr		Ersatz von					Blatt	387

VIPA\332-5HD50.EMA

A1

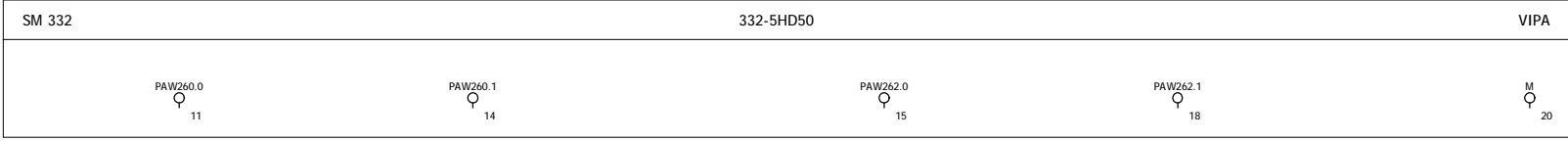

3

+332_5HD60/1

			Datum	08.05.2014	Produktmakros System 300S		Ausgangskanal 2/3 SM 332 AO 4x12Bit I 332-5HD50		=	+ 332_5HD50	Blatt 4
			Bearb.	Winkler							
			Gepr								
Anderung	Datum	Name	Urspr		Ersatz von						Blatt 387

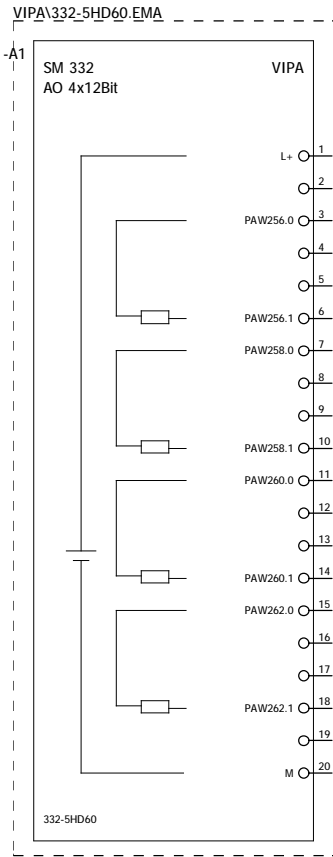

+332_5HD50/4

2

			Datum	08.05.2014	Produktmakros System 300S
			Bearb.	Winkler	
			Gepr		
Anderung	Datum	Name	Urspr		Ersatz von



SPS-Übersicht
SM 332 AO 4x12Bit U
332-5HD60

		=
		+ 332_5HD60
		Blatt 1
		Blatt 387

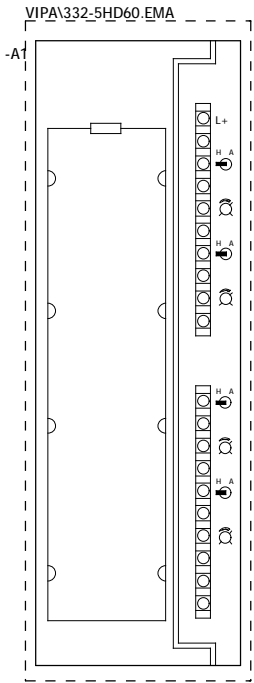

		Datum	30.11.2010	Produktmakros System 300S
		Bearb.	Winkler	
		Gepr.		
Anderung	Datum	Name	Urspr.	Ersatz von



Frontansicht
SM 332 AO 4x12Bit U
332-5HD60

		=
		+ 332_5HD60
		Blatt 2
		Blatt 387

VIPA\332-5HD60.EMA

A1

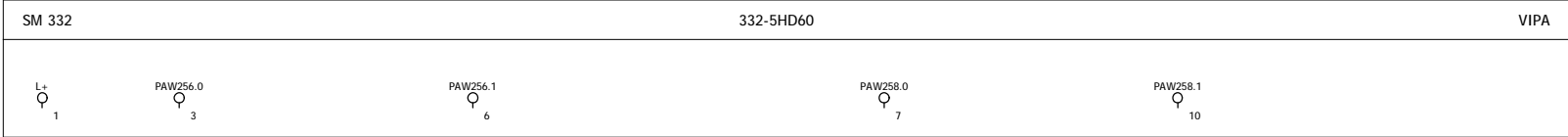

			Datum	08.05.2014	Produktmakros System 300S	YASKAWA	Ausgangskanal 0/1 SM 332 AO 4x12Bit U 332-5HD60	=	+ 332_5HD60	Blatt 3
			Bearb.	Winkler						
			Gepr							
Anderung	Datum	Name	Urspr		Ersatz von					Blatt 387

VIPA\332-5HD60.EMA

A1

SM 332

332-5HD60

VIPA

PAW260.0
11

PAW260.1
14

PAW262.0
15

PAW262.1
18

M
20

3

+334_OKE00/1

	Datum	08.05.2014	Produktmakros System 300S	
	Bearb.	Winkler		
	Gepr			
Anderung	Datum	Name	Urspr	Ersatz von



Ausgangskanal 2/3
SM 332 AO 4x12Bit U
332-5HD60

		=
		+ 332_5HD60
	Blatt	4
	Blatt	387

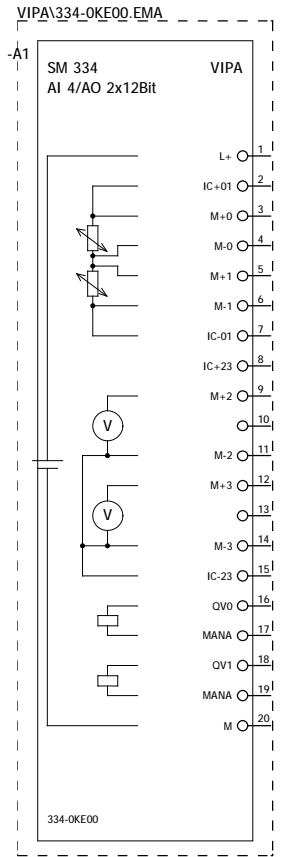

+332_5HD60/4

2

			Datum	08.05.2014	Produktmakros System 300S
			Bearb.	Winkler	
			Gepr		
Anderung	Datum	Name	Urspr		Ersatz von



SPS-Übersicht
SM 334 AI 4/AO 2x12Bit
334-0KE00

		=
		+ 334_0KE00
		Blatt 1
		Blatt 387

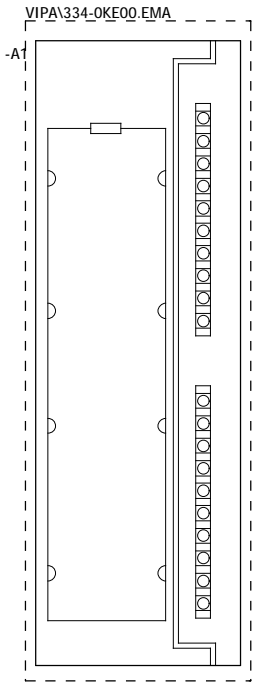

			Datum	30.11.2010	Produktmakros System 300S
			Bearb.	Winkler	
			Gepr		
Anderung	Datum	Name	Urspr		Ersatz von



Frontansicht
SM 334 AI 4/AO 2x12Bit
334-OKE00

		=
		+ 334_OKE00
		Blatt 2
		Blatt 387

VIPA\334-OKE00.EMA

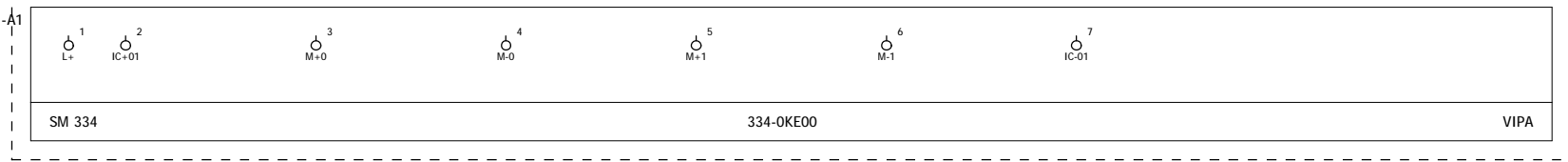

			Datum	08.05.2014	Produktmakros System 300S	YASKAWA	Eingangskanal 0-1 SM 334 AI 4/AO 2x12Bit 334-OKE00	=	+ 334_OKE00	Blatt	3
			Bearb.	Winkler							3
			Gepr								3
Anderung	Datum	Name	Urspr		Ersatz von					Blatt	387

VIPA\334-OKE00.EMA

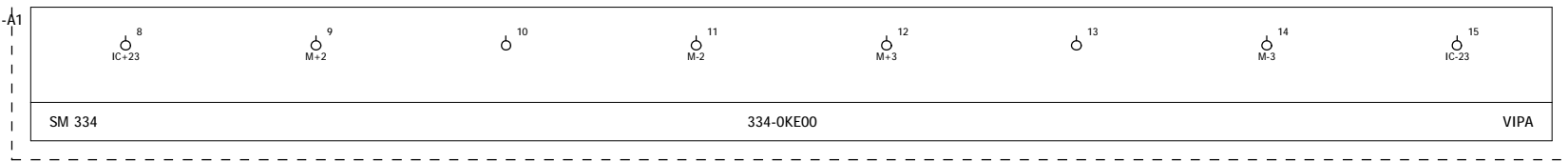

			Datum	08.05.2014	Produktmakros System 300S	YASKAWA	Eingangskanal 2-3 SM 334 AI 4/AO 2x12Bit 334-OKE00		=	+ 334_OKE00	Blatt	4
			Bearb.	Winkler								
			Gepr									
Anderung	Datum	Name	Urspr		Ersatz von						Blatt	387

VIPA\334-OKE00.EMA

A1

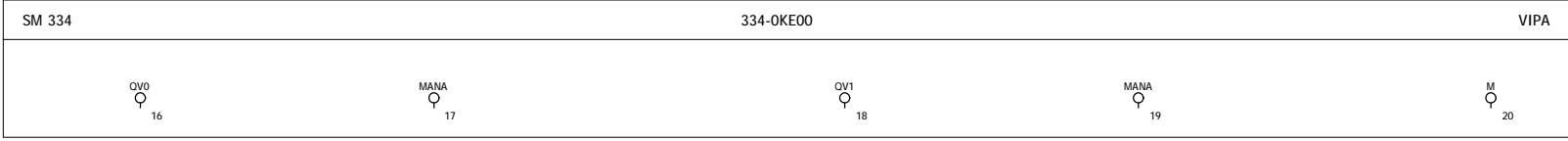

4

+341_1AH01/1

	Datum	08.05.2014	Produktmakros System 300S	
	Bearb.	Winkler		
	Gepr			
Anderung	Datum	Name	Urspr	Ersatz von



Ausgangskanal 0-1
SM 334 AI 4/AO 2x12Bit
334-OKE00

		=
		+ 334_OKE00
	Blatt	5
	Blatt	387

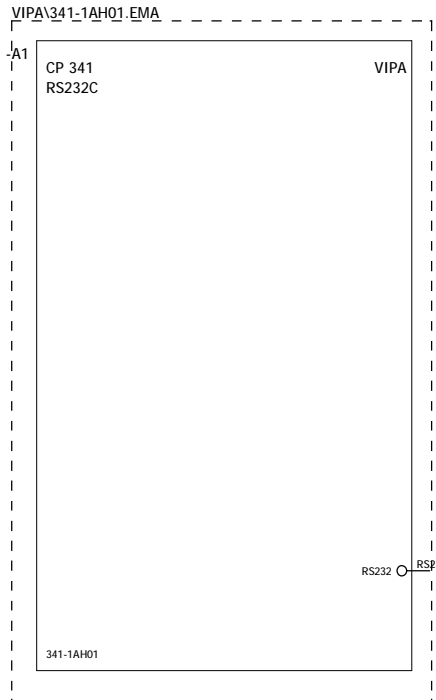

+334_OKE00/5

2

			Datum	08.05.2014	Produktmakros System 300S		SPS-Übersicht CP 341-RS232 341-1AH01		=	+ 341_1AH01	Blatt	1
			Bearb.	Winkler							Blatt	387
			Gepr									
Anderung	Datum	Name	Urspr		Ersatz von							

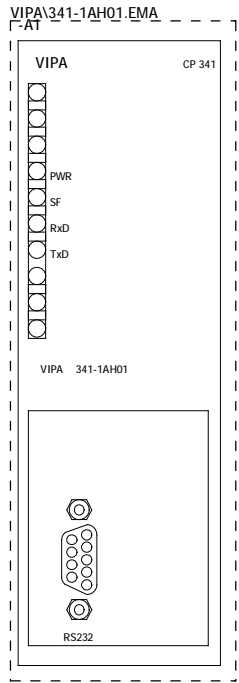

			Datum	08.05.2014	Produktmakros System 300S
			Bearb.	Winkler	
			Gepr		
Anderung	Datum	Name	Urspr		Ersatz von



Frontansicht
CP 341-RS232
341-1AH01

		=
		+ 341_1AH01
		Blatt 2
		Blatt 387

VIPA\341-1AH01.EMA

-A1

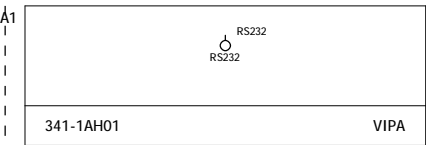

			Datum	08.05.2014	Produktmakros System 300S
			Bearb.	Winkler	
			Gepr		
Anderung	Datum	Name	Urspr		Ersatz von



Anschlußbelegung
 CP 341-RS232
 341-1AH01

		=	
		+ 341_1AH01	
		Blatt	3
		Blatt	387

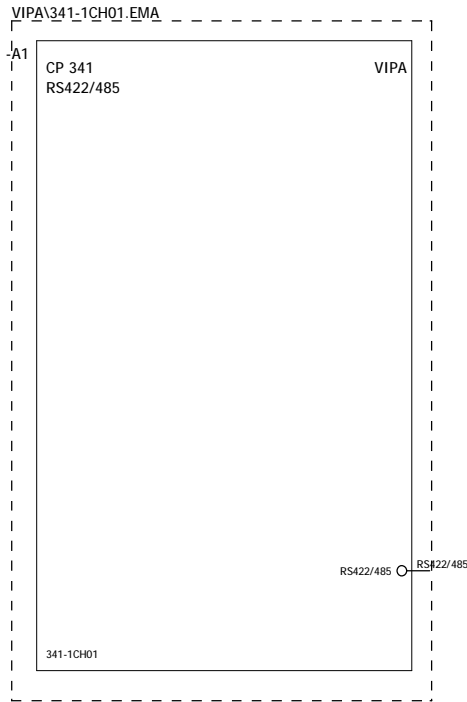

+341_1AH01/3

2

			Datum	08.05.2014	Produktmakros System 300S		SPS-Übersicht CP 341-RS422/485 341-1CH01		=	+ 341_1CH01	Blatt	1
			Bearb.	Winkler							Blatt	387
			Gepr									
Anderung	Datum	Name	Urspr		Ersatz von							

VIPA\341-1CH01.EMA

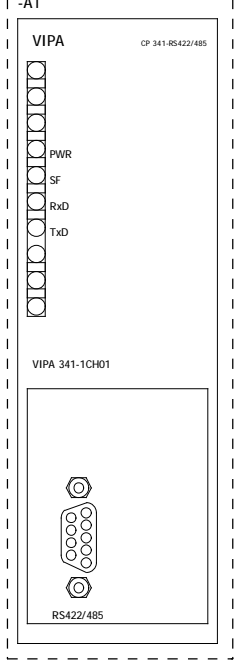

			Datum	08.05.2014	Produktmakros System 300S
			Bearb.	Winkler	
			Gepr		
Anderung	Datum	Name	Urspr		Ersatz von



Frontansicht
CP 341-RS422/485
341-1CH01

		=
		+ 341_1CH01
		Blatt 2
		Blatt 387

VIPA\341-1CH01.EMA

-A1

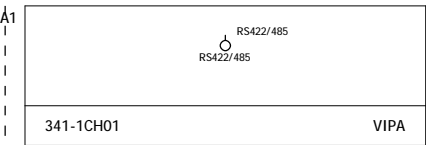

			Datum	08.05.2014	Produktmakros System 300S	YASKAWA	Anschlußbelegung CP 341-RS422/485 341-1CH01		=	+ 341_1CH01	Blatt	3
			Bearb.	Winkler							Blatt	387
			Gepr									
Anderung	Datum	Name	Urspr		Ersatz von							

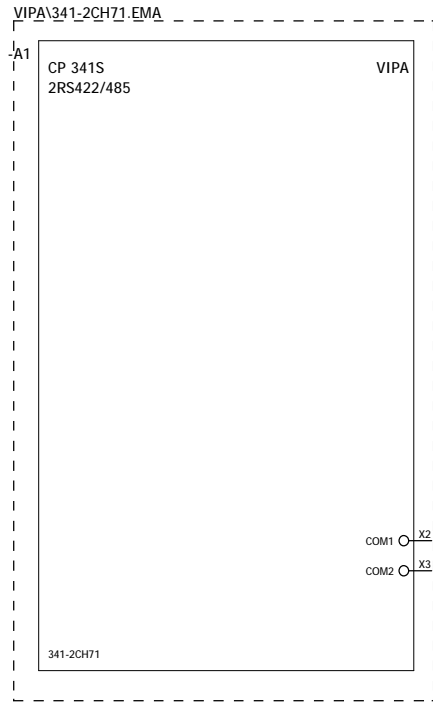

+341_1CH01/3

2

			Datum	08.05.2014	Produktmakros System 300S		SPS-Übersicht CP 341S-2RS422/485, 341-2CH71		=	+ 341_2CH71	Blatt	1
			Bearb.	Winkler							Blatt	387
			Gepr									
Anderung	Datum	Name	Urspr		Ersatz von							

VIPA\341-2CH71.EMA

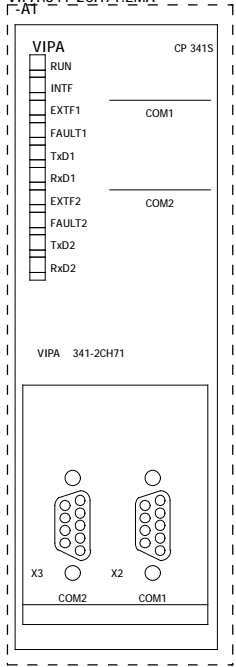

			Datum	30.11.2010	Produktmakros System 300S
			Bearb.	Winkler	
			Gepr		
Anderung	Datum	Name	Urspr		Ersatz von



Frontansicht
 CP 341S-2RS422/485,
 341-2CH71

		=
		+ 341_2CH71
		Blatt 2
		Blatt 387

VIPA\341-2CH71.EMA

-A1

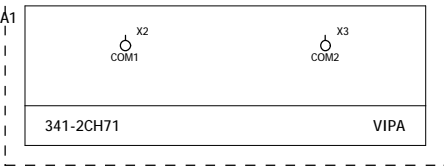

			Datum	08.05.2014	Produktmakros System 300S
			Bearb.	Winkler	
			Gepr.		
Anderung	Datum	Name	Urspr.		Ersatz von



Anschlußbelegung
 CP 341S-2RS422/485,
 341-2CH71

		=	
		+ 341_2CH71	
		Blatt	3
		Blatt	387

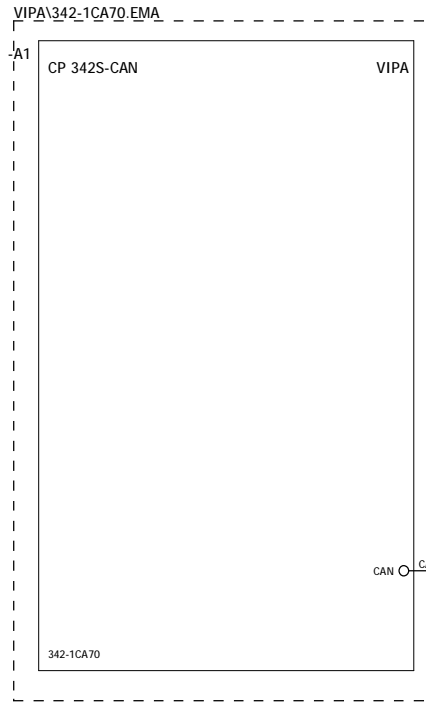

+341_2CH71/3

2

			Datum	08.05.2014	Produktmakros System 300S
			Bearb.	Winkler	
			Gepr		
Anderung	Datum	Name	Urspr		Ersatz von



SPS-Übersicht
CP 342S-CAN,
342-1CA70

		=	
		+ 342_1CA70	
			Blatt 1
			Blatt 387

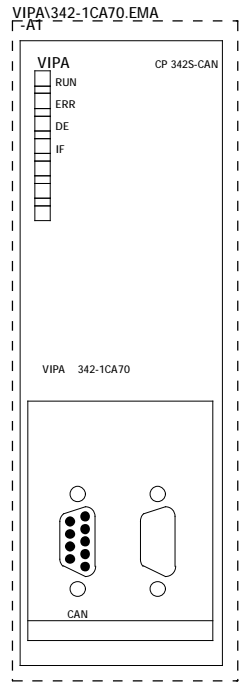

			Datum	30.11.2010	Produktmakros System 300S
			Bearb.	Winkler	
			Gepr		
Anderung	Datum	Name	Urspr		Ersatz von



Frontansicht
CP 342S-CAN,
342-1CA70

		=
		+ 342_1CA70
		Blatt 2
		Blatt 387

VIPA\342-1CA70.EMA

-A1

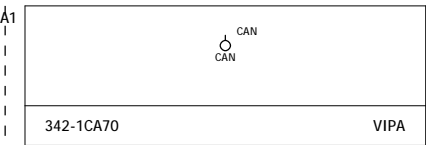

			Datum	08.05.2014	Produktmakros System 300S	YASKAWA	Anschlußbelegung CP 342S-CAN, 342-1CA70		=	+ 342_1CA70	Blatt	3
			Bearb.	Winkler							Blatt	387
			Gepr									
Anderung	Datum	Name	Urspr		Ersatz von							

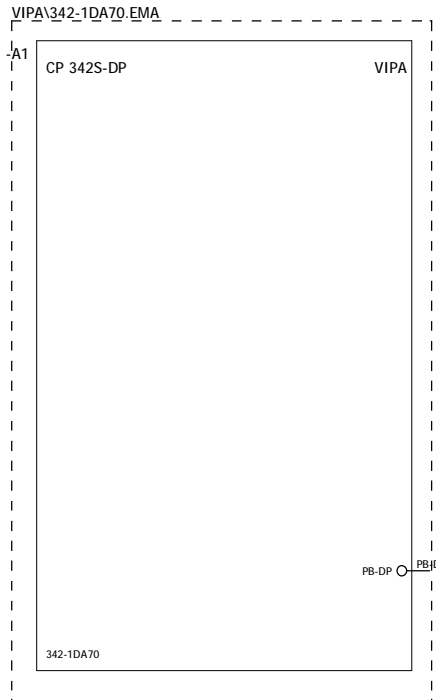

+342_1CA70/3

2

			Datum	08.05.2014	Produktmakros System 300S		SPS-Übersicht CP 342S-DP, 342-1DA70		=	+ 342_1DA70	Blatt	1
			Bearb.	Winkler								
			Gepr									
Anderung	Datum	Name	Urspr		Ersatz von						Blatt	387

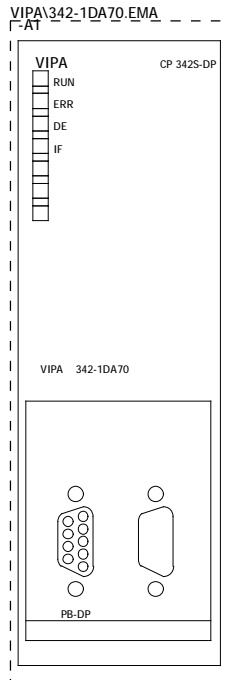

		Datum	30.11.2010	Produktmakros System 300S
		Bearb.	Winkler	
		Gepr		
Anderung	Datum	Name	Urspr	Ersatz von



Frontansicht
CP 342S-DP,
342-1DA70

		=
		+ 342_1DA70
		Blatt 2
		Blatt 387

VIPA\342-1DA70.EMA

-A1



			Datum	08.05.2014	Produktmakros System 300S	YASKAWA	Anschlußbelegung CP 342S-DP, 342-1DA70		=	+ 342_1DA70	Blatt 3
			Bearb.	Winkler							
			Gepr								
Anderung	Datum	Name	Urspr		Ersatz von						Blatt 387

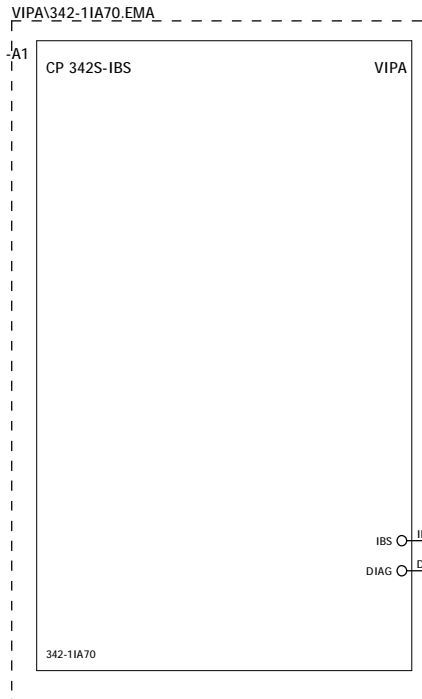

+342_1DA70/3

2

			Datum	08.05.2014	Produktmakros System 300S
			Bearb.	Winkler	
			Gepr		
Anderung	Datum	Name	Urspr		Ersatz von



SPS-Übersicht
CP 342S-IBS,
342-11A70

		=
		+ 342_11A70
		Blatt 1
		Blatt 387

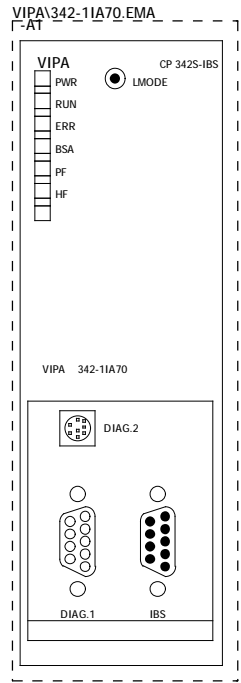

			Datum	30.11.2010	Produktmakros System 300S
			Bearb.	Winkler	
			Gepr		
Anderung	Datum	Name	Urspr		Ersatz von



Frontansicht
CP 342S-IBS,
342-11A70

		=
		+ 342_11A70
		Blatt 2
		Blatt 387

VIPA\342-11A70.EMA

-A1

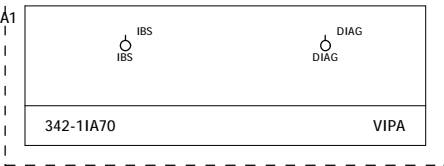

			Datum	08.05.2014	Produktmakros System 300S
			Bearb.	Winkler	
			Gepr		
Anderung	Datum	Name	Urspr		Ersatz von



Anschlußbelegung
CP 342S-IBS,
342-11A70

		=	
		+ 342_11A70	
		Blatt	3
		Blatt	387

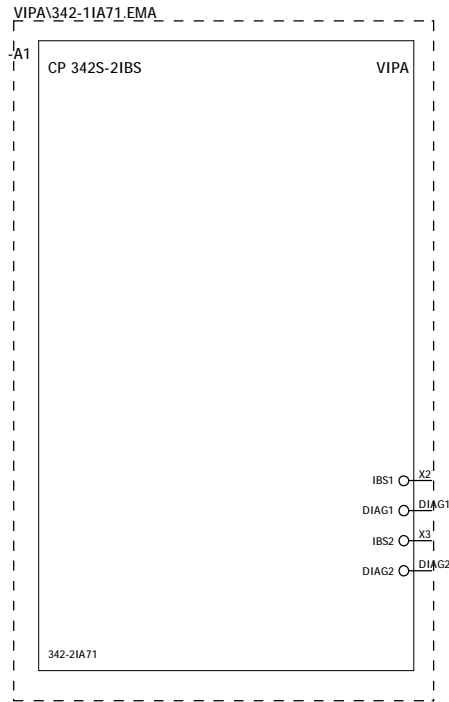

+342_1IA70/3

2

			Datum	08.05.2014	Produktmakros System 300S
			Bearb.	Winkler	
			Gepr		
Anderung	Datum	Name	Urspr		Ersatz von



SPS-Übersicht
CP 342S-2IBS,
342-2IA71

		=
		+ 342_2IA71
		Blatt 1
		Blatt 387

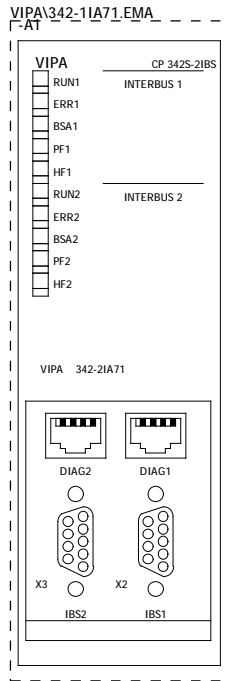

			Datum	30.11.2010	Produktmakros System 300S
			Bearb.	Winkler	
			Gepr		
Anderung	Datum	Name	Urspr		Ersatz von



Frontansicht
 CP 342S-2IBS,
 342-2IA71

		=
		+ 342_2IA71
		Blatt 2
		Blatt 387

VIPA\342-1IA71.EMA

-A1

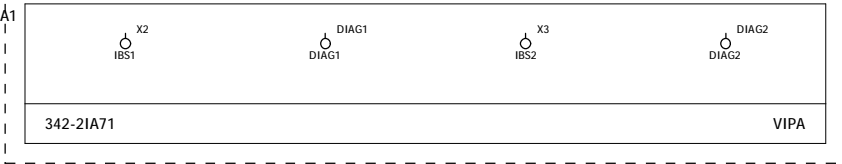

			Datum	08.05.2014	Produktmakros System 300S	YASKAWA	Anschlußbelegung CP 342S-2IBS, 342-2IA71	=	+ 342_2IA71	Blatt 3
			Bearb.	Winkler						
			Gepr							
Anderung	Datum	Name	Urspr		Ersatz von					Blatt 387

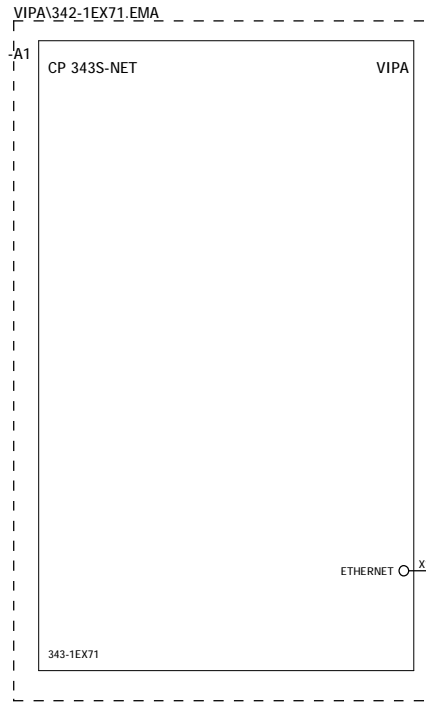

+342_2IA71/3

2

			Datum	08.05.2014	Produktmakros System 300S
			Bearb.	Winkler	
			Gepr		
Anderung	Datum	Name	Urspr		Ersatz von



SPS-Übersicht
CP 343S-NET,
343-1EX71

=
+ 343_1EX71

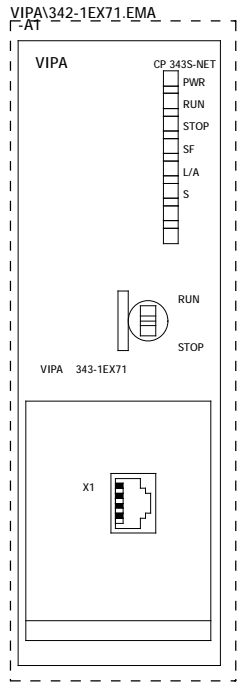

			Datum	30.11.2010	Produktmakros System 300S
			Bearb.	Winkler	
			Gepr		
Anderung	Datum	Name	Urspr		Ersatz von



Frontansicht
CP 343S-NET,
343-1EX71

		=
		+ 343_1EX71
		Blatt 2
		Blatt 387

VIPA\342-1EX71.EMA

-A1

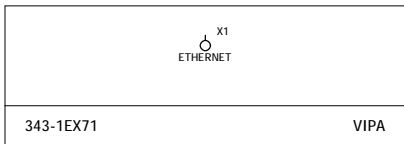

			Datum	08.05.2014	Produktmakros System 300S	YASKAWA	Anschlußbelegung CP 343S-NET, 343-1EX71	=	
		Bearb.	Winkler	+ 343_1EX71					
		Gepr		Blatt				3	
Anderung	Datum	Name	Urspr		Ersatz von			Blatt	387

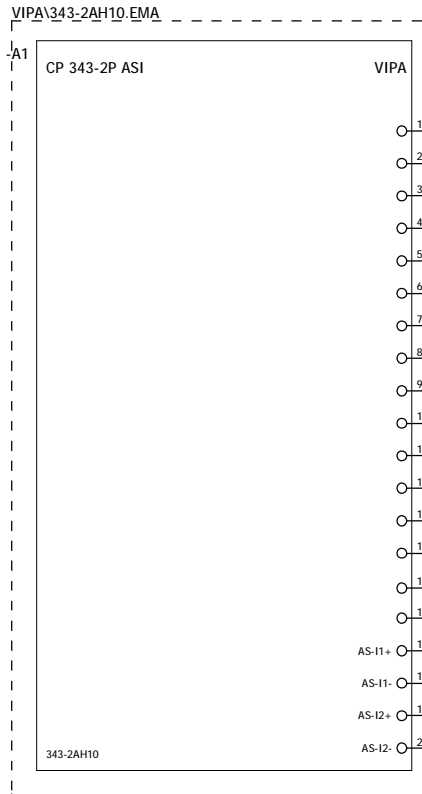

+343_1EX71/3

2

			Datum	08.05.2014	Produktmakros System 300S
			Bearb.	Winkler	
			Gepr		
Anderung	Datum	Name	Urspr		Ersatz von



SPS-Übersicht
CP343-2P AS-i
343-2AH10

		=
		+ 343_2AH10
		Blatt 1
		Blatt 387

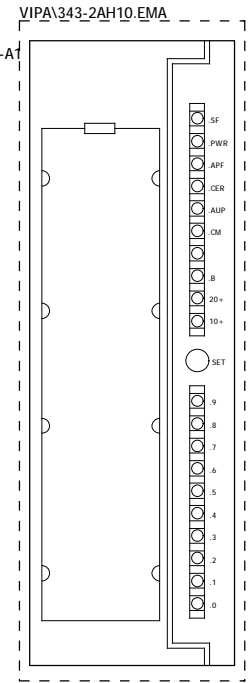

		Datum	30.11.2010	Produktmakros System 300S
		Bearb.	Winkler	
		Gepr.		
Anderung	Datum	Name	Urspr.	Ersatz von



Frontansicht
CP343-2P AS-i
343-2AH10

		=
		+ 343_2AH10
		Blatt 2
		Blatt 387

VIPA\343-2AH10.EMA

-A1

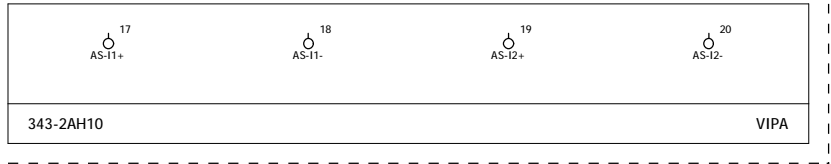

			Datum	08.05.2014	Produktmakros System 300S	YASKAWA	Anschlußbelegung CP343-2P AS-i 343-2AH10	=	
			Bearb.	Winkler				+ 343_2AH10	
			Gepr					Blatt	3
Anderung	Datum	Name	Urspr		Ersatz von			Blatt	387

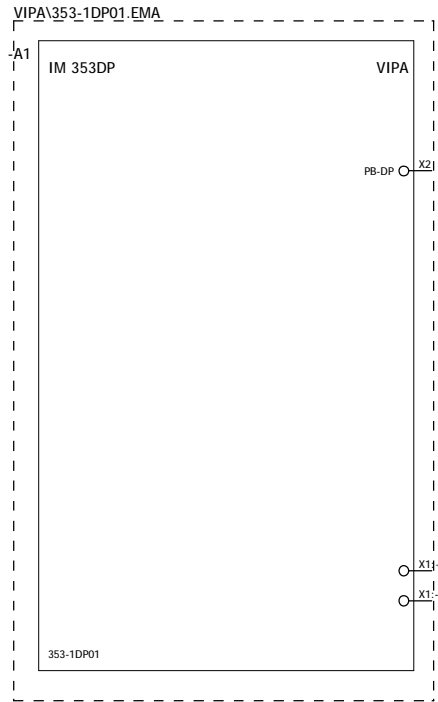

+343_2AH10/3

2

			Datum	08.05.2014	Produktmakros System 300S
			Bearb.	Winkler	
			Gepr		
Anderung	Datum	Name	Urspr		Ersatz von



SPS-Übersicht
IM 353DP-DP-Slave
353-1DP01

		=
		+ 353_1DP01
		Blatt 1
		Blatt 387

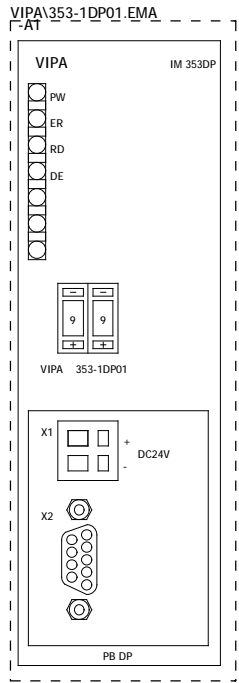

			Datum	08.05.2014	Produktmakros System 300S
			Bearb.	Winkler	
			Gepr		
Anderung	Datum	Name	Urspr		Ersatz von



Frontansicht
 IM 353DP-DP-Slave
 353-1DP01

		=
		+ 353_1DP01
		Blatt 2
		Blatt 387

VIPA\353-1DP01.EMA

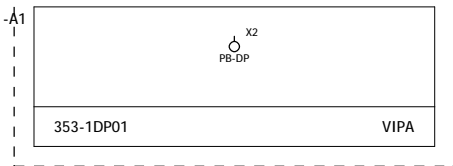

VIPA\353-1DP01.EMA

